

Contemporary Tilt & Turn Window Cill Extension Options

DIMENSIONS	PLOT SIZE	SCALE	DATE	REV	DWG NO.
MM	A4	1:1	25.09.2019	B	0001

Please consider the environment before printing

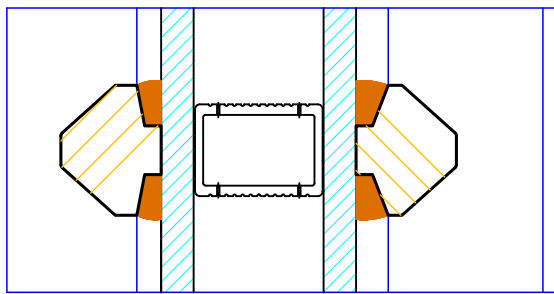

16

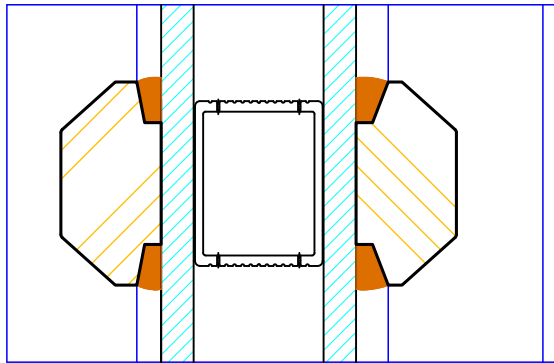

25

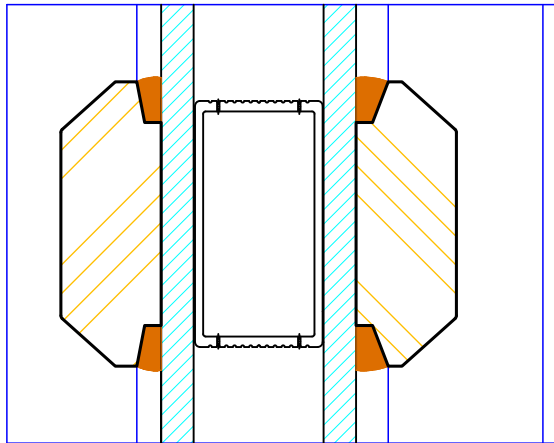

35

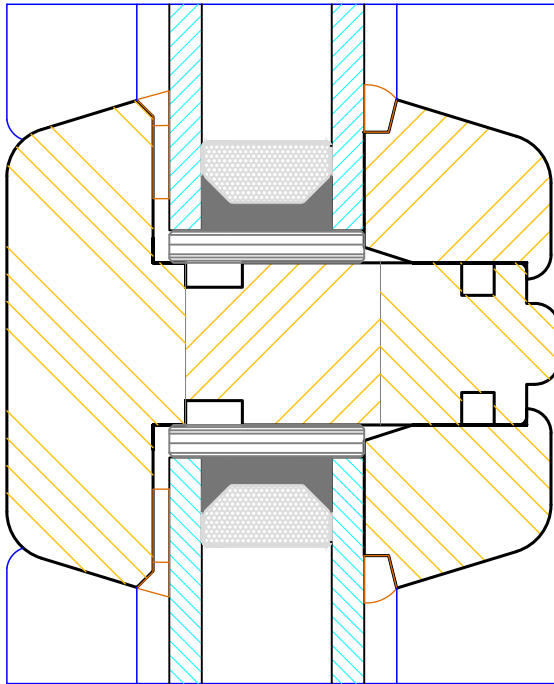

60 (varies min 60 / max 110mm)

68

22 16 22



Bereco

Contemporary Tilt & Turn Window Bar Options

DIMENSIONS	PLOT SIZE	SCALE	DATE	REV	DWG NO.
MM	A4	1:1	13.01.2011	A	0002

Please consider the environment before printing

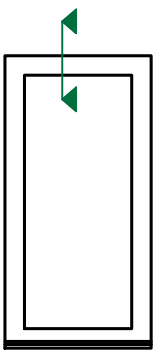
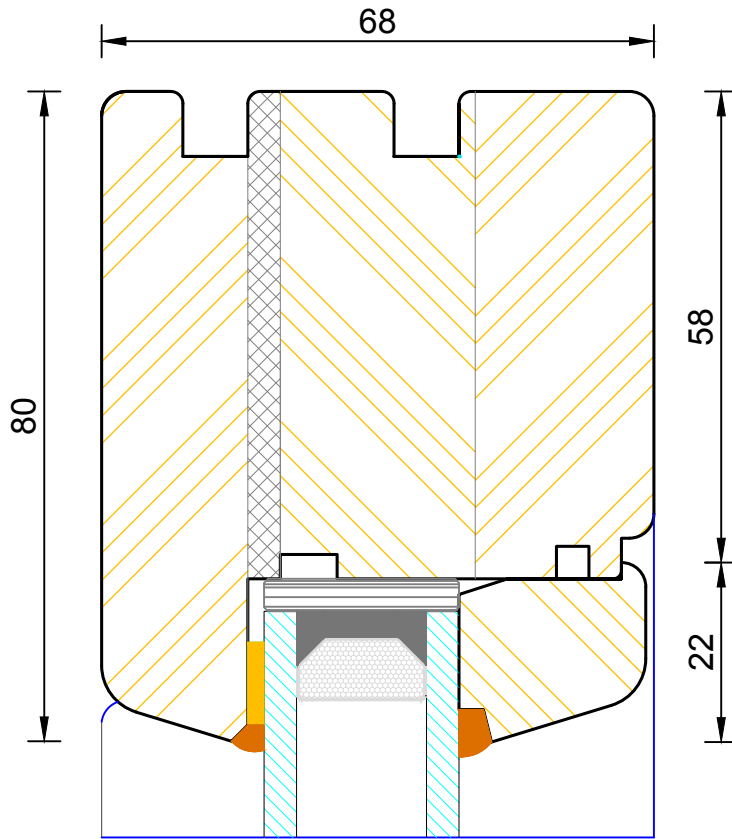

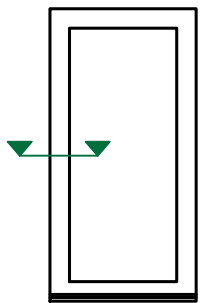
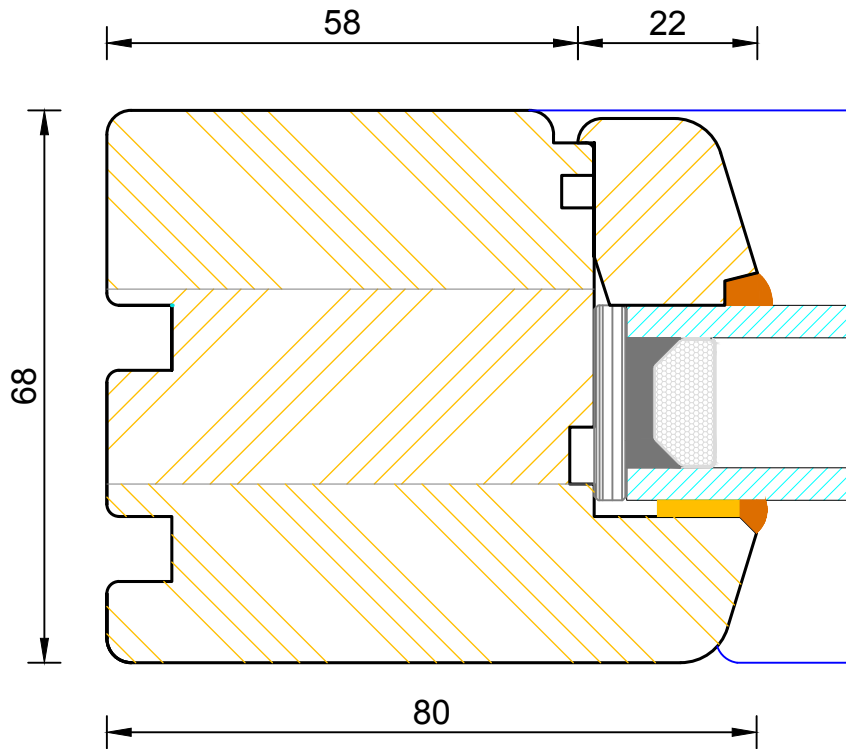

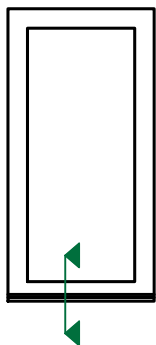
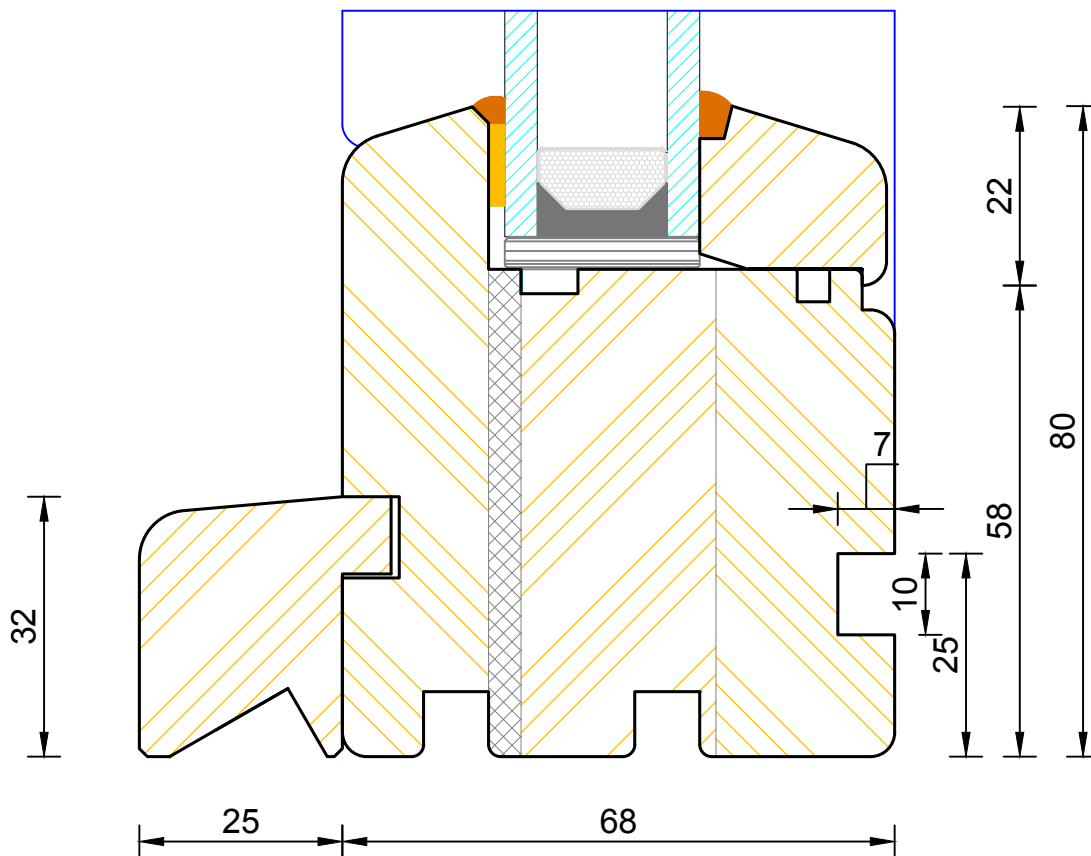

CILL EXTENSION - available options:
 25mm (93mm o/a) / 47mm (115mm o/a)
 / 62mm (130mm o/a) / 87mm (155mm
 o/a) / 114mm (182mm o/a) / 125mm
 (193mm o/a) / 140mm (208mm o/a)

DIMENSIONS	PLOT SIZE	SCALE	DATE	REV	DWG NO.
MM	A4	1:1	22.03.2011	A	0005
Please consider the environment before printing					

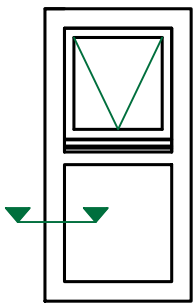
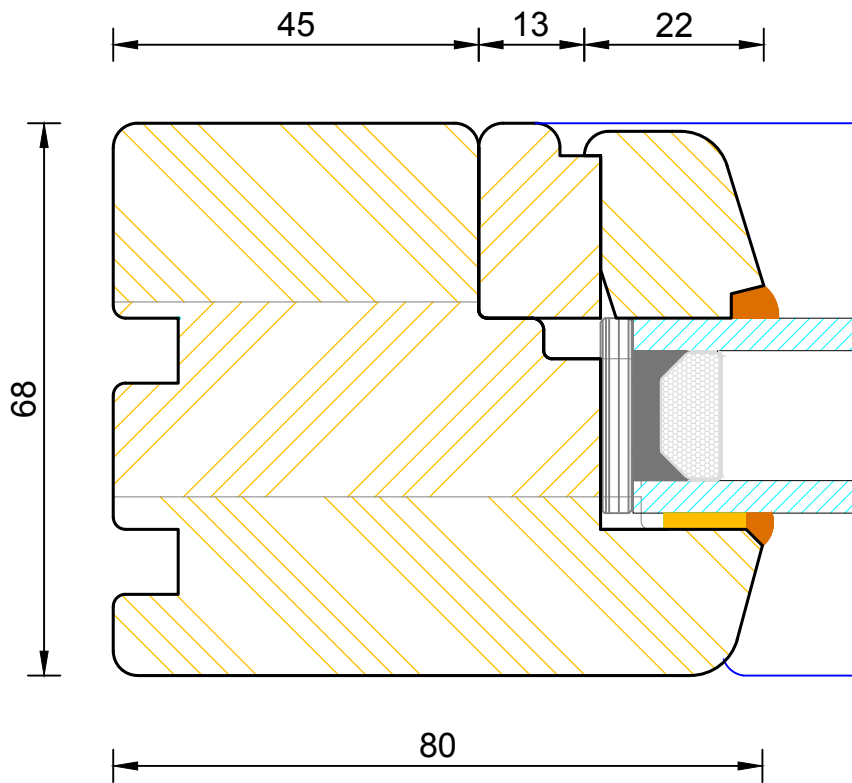

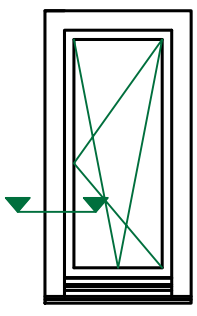
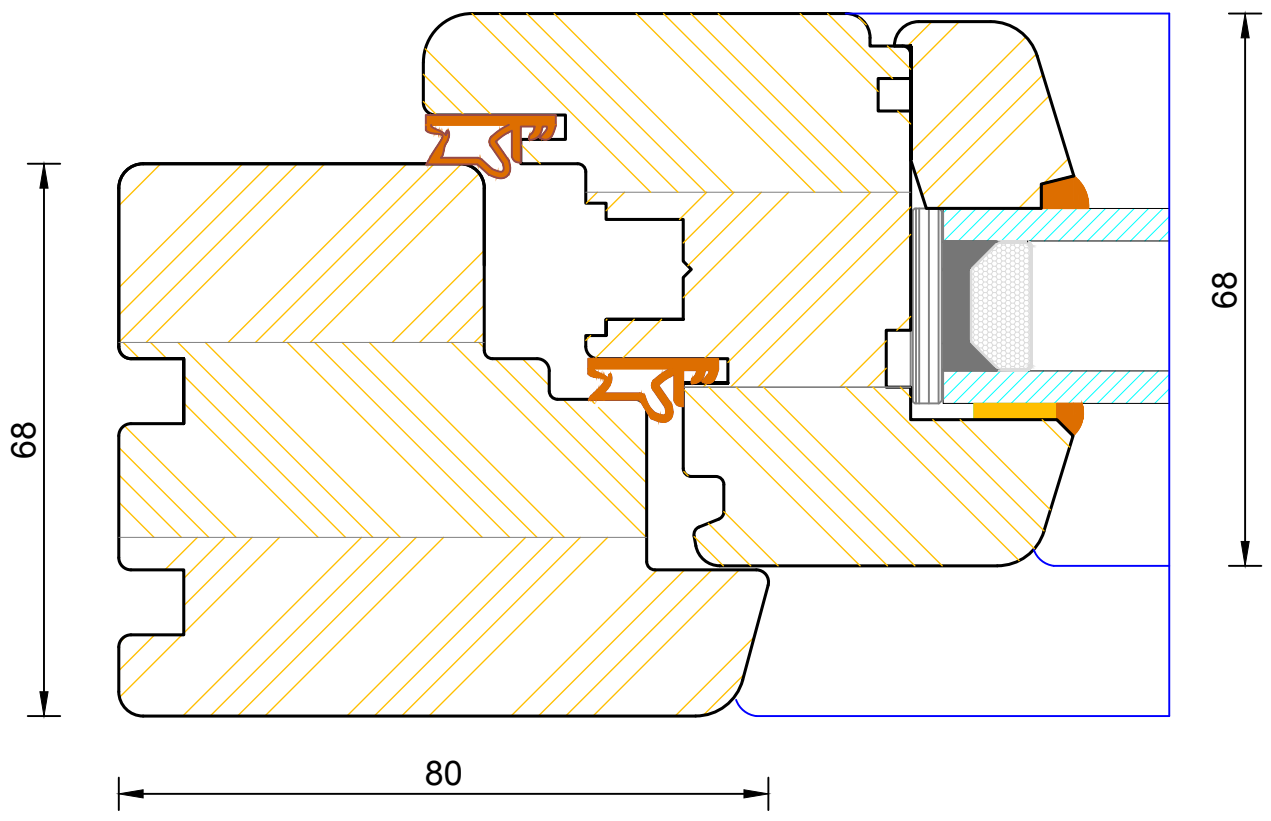
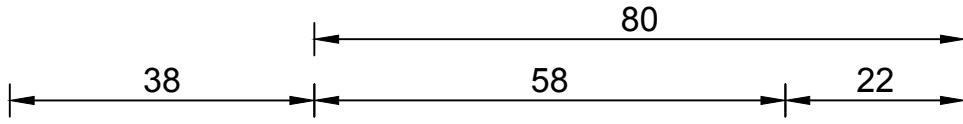

**Contemporary Tilt & Turn Window
Frame & Sash Jamb**

DIMENSIONS	PLOT SIZE	SCALE	DATE	REV	DWG NO.
MM	A4	1:1	22.03.2011	A	0007
Please consider the environment before printing					

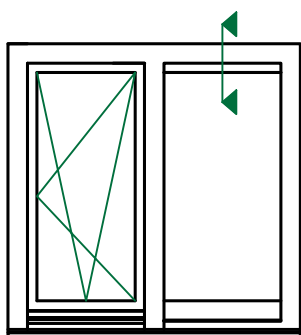
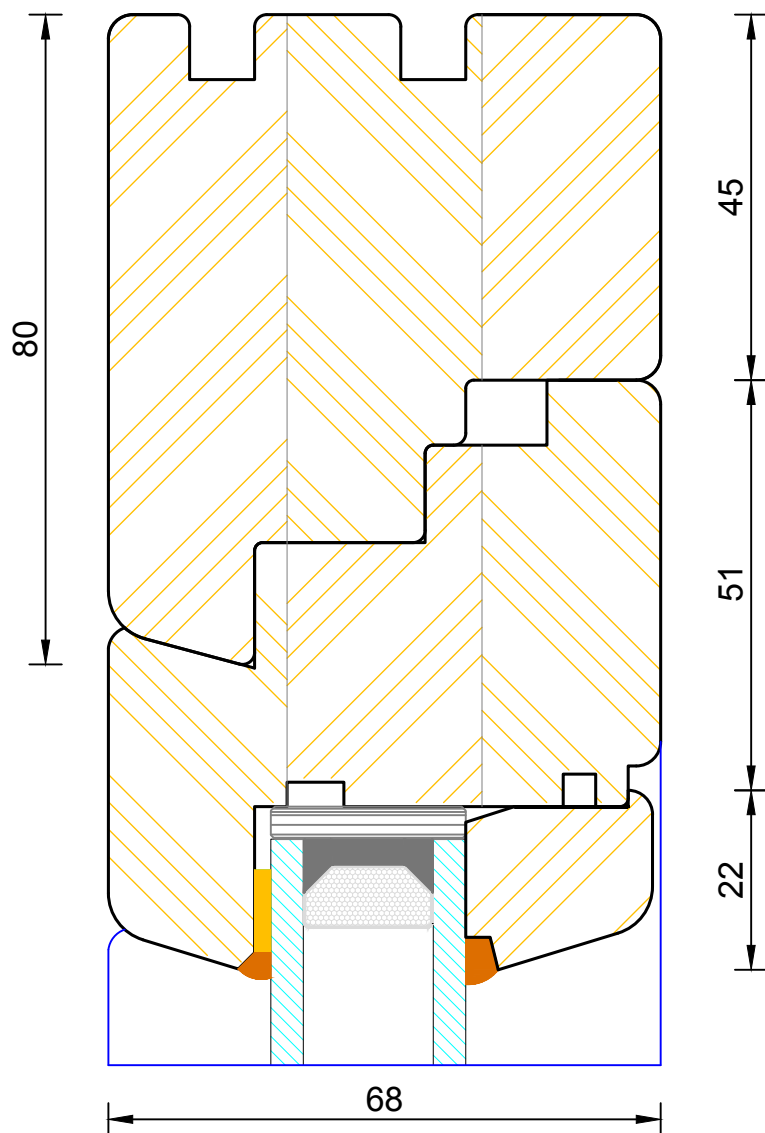

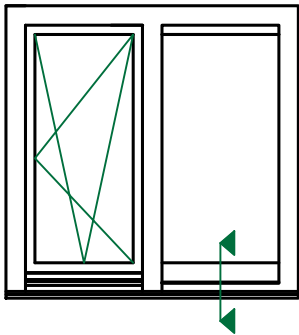
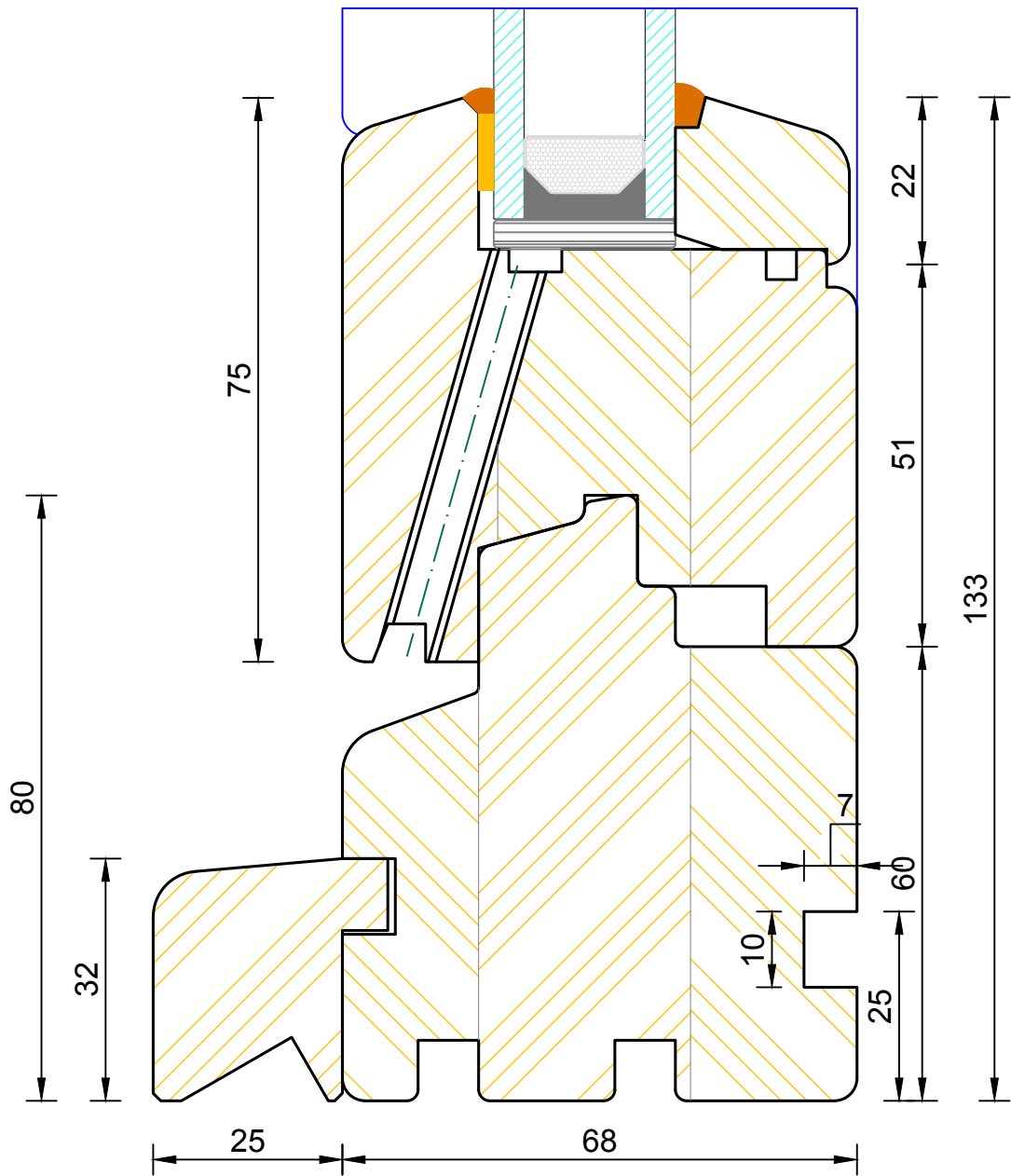

CILL EXTENSION - available options:
 25mm (93mm o/a) / 47mm (115mm o/a)
 / 62mm (130mm o/a) / 87mm (155mm
 o/a) / 114mm (182mm o/a) / 125mm
 (193mm o/a) / 140mm (208mm o/a)

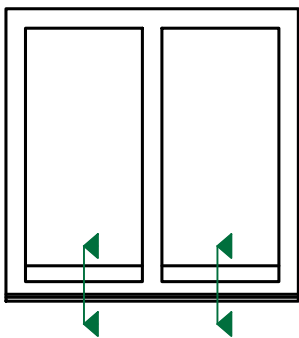
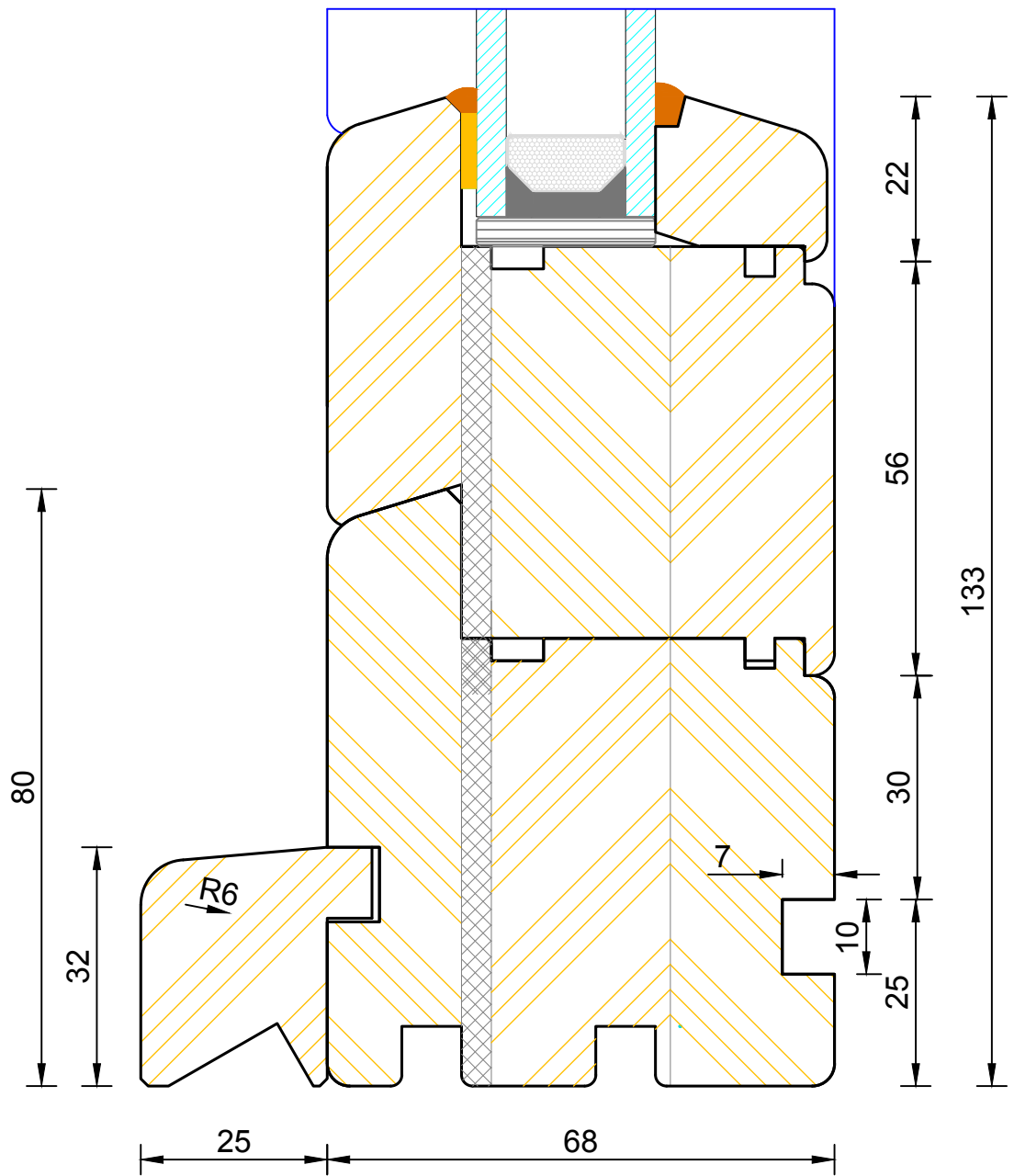

CILL EXTENSION - available options:
 25mm (93mm o/a) / 47mm (115mm o/a)
 / 62mm (130mm o/a) / 87mm (155mm
 o/a) / 114mm (182mm o/a) / 125mm
 (193mm o/a) / 140mm (208mm o/a)

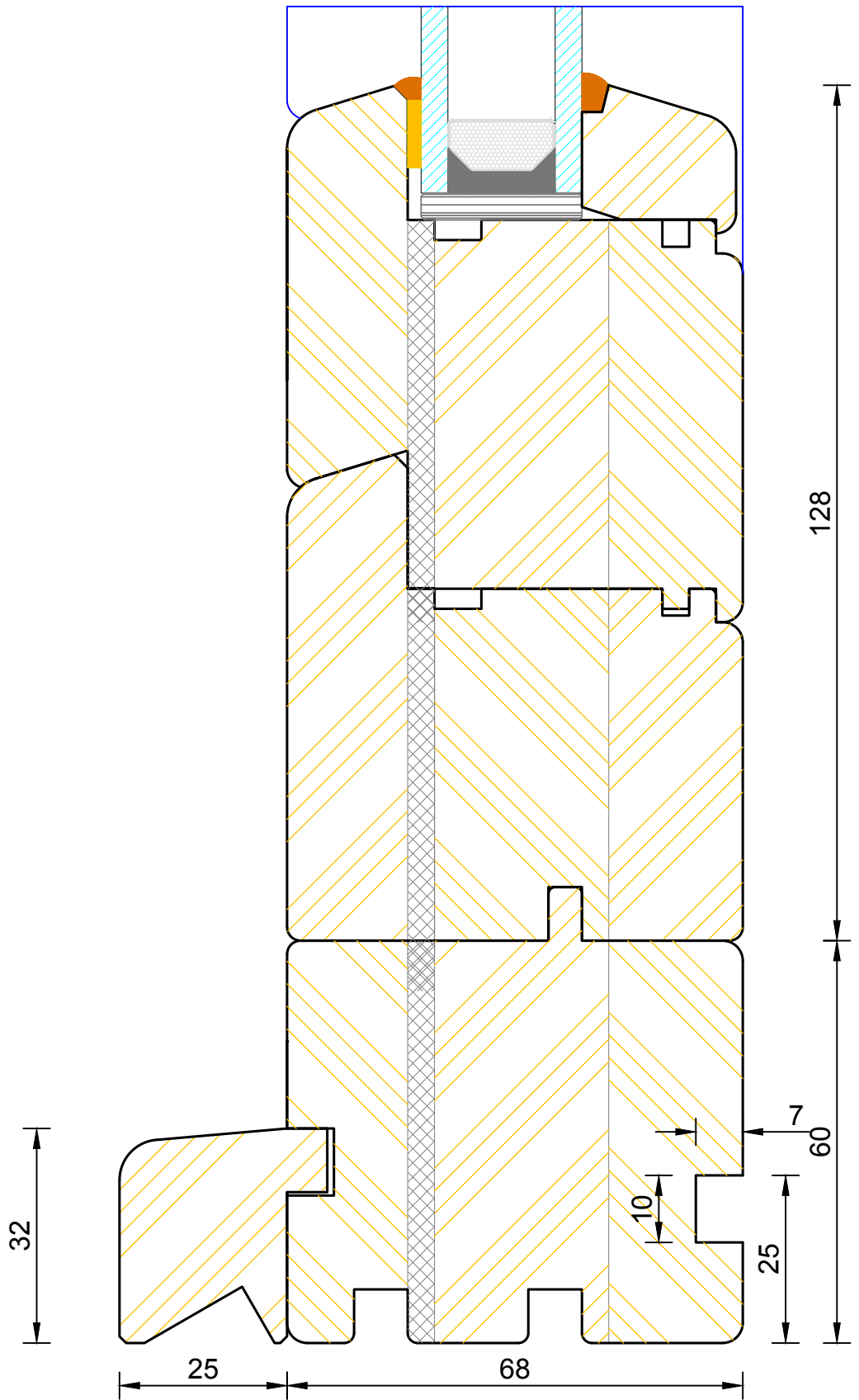
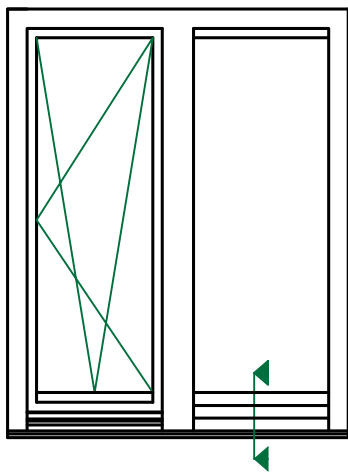

CILL EXTENSION - available options:
 25mm (93mm o/a) / 47mm (115mm o/a) / 62mm (130mm o/a)
 / 87mm (155mm o/a) / 114mm (182mm o/a) / 125mm (193mm
 o/a) / 140mm (208mm o/a)



Contemporary Tilt & Turn Window Fixed Light Cill (Balcony Door)

DIMENSIONS	PLOT SIZE	SCALE	DATE	REV	DWG NO.
MM	A4	1:1	22.03.2011	A	0011
 Please consider the environment before printing					

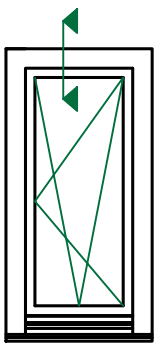
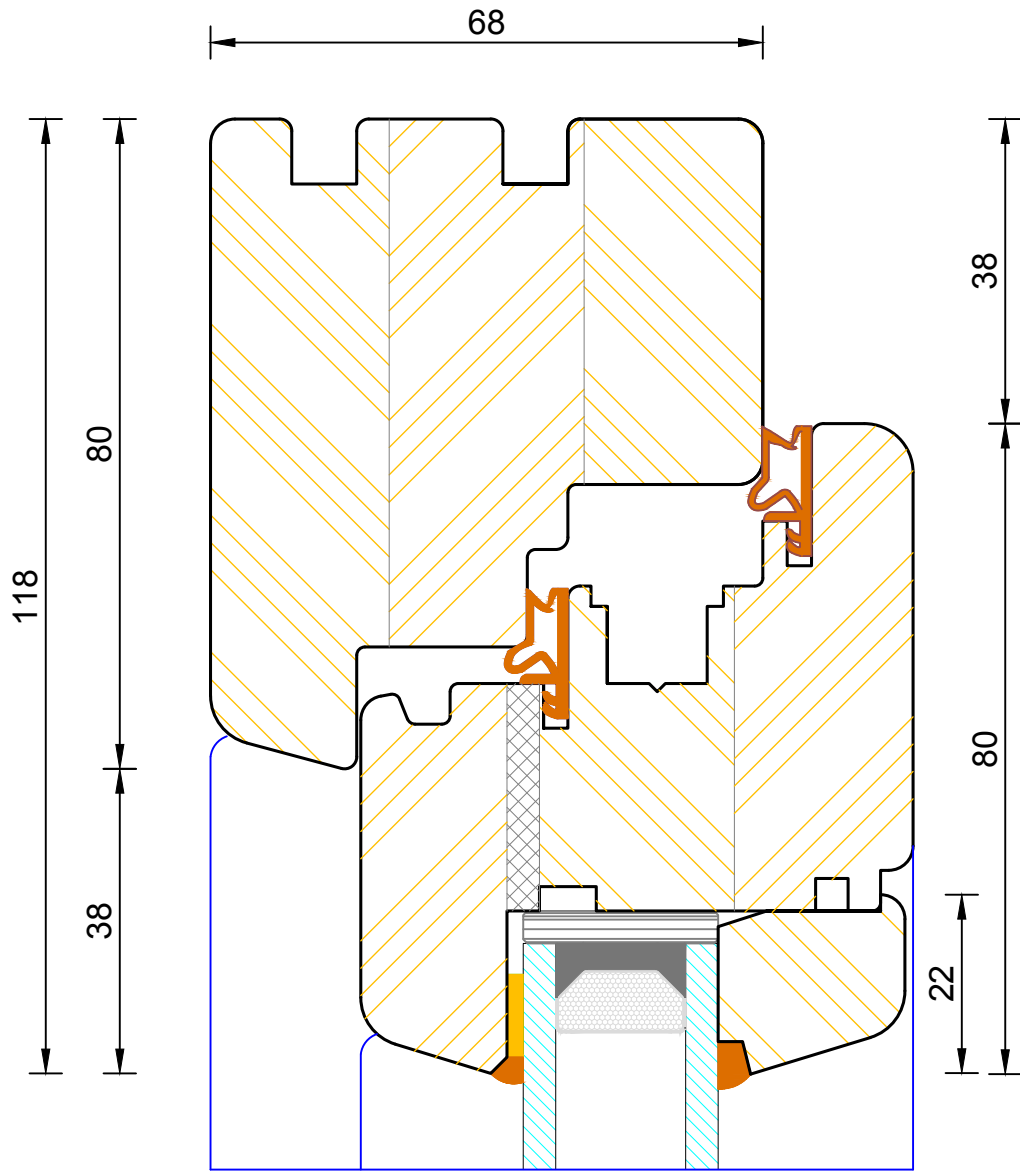

**Contemporary Tilt & Turn Window
Frame & Sash Head (No Vent)**

DIMENSIONS	PLOT SIZE	SCALE	DATE	REV	DWG NO.
MM	A4	1:1	22.03.2011	A	0012

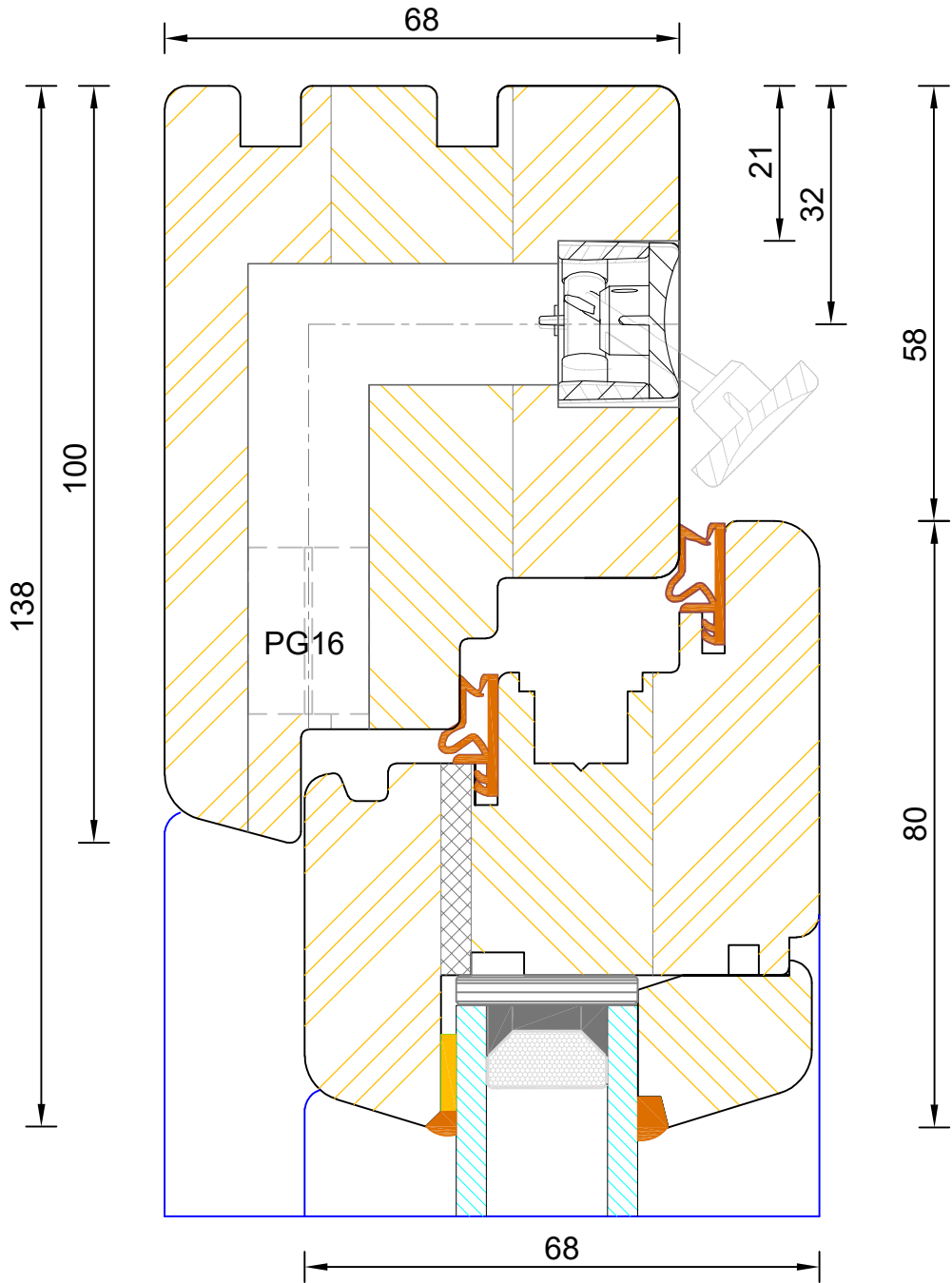
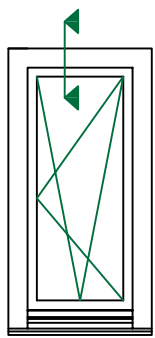

Contemporary Tilt & Turn Window Frame & Sash Head (With Vent)

DIMENSIONS	PLOT SIZE	SCALE	DATE	REV	DWG NO.
MM	A4	1:1	05.07.2022	B	0013

Please consider the environment before printing

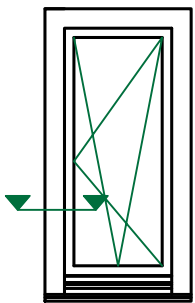
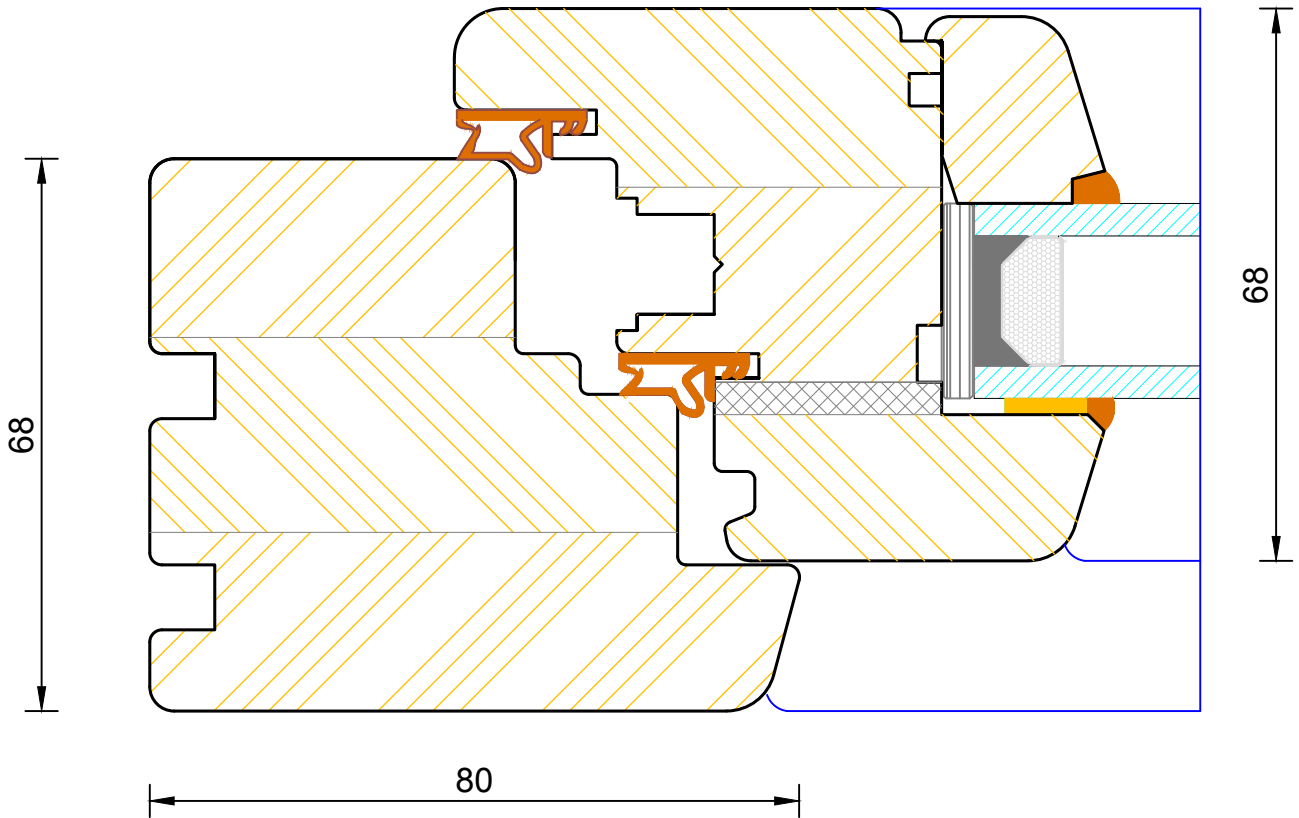
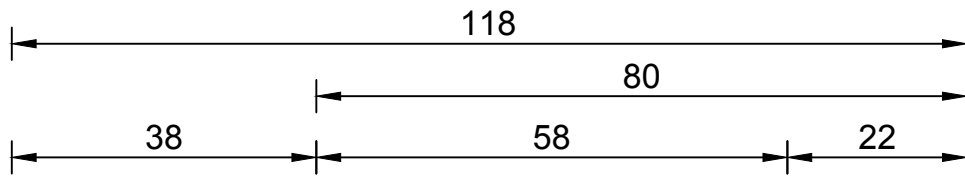

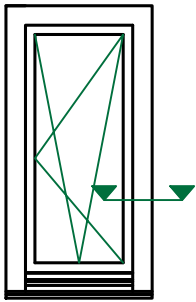
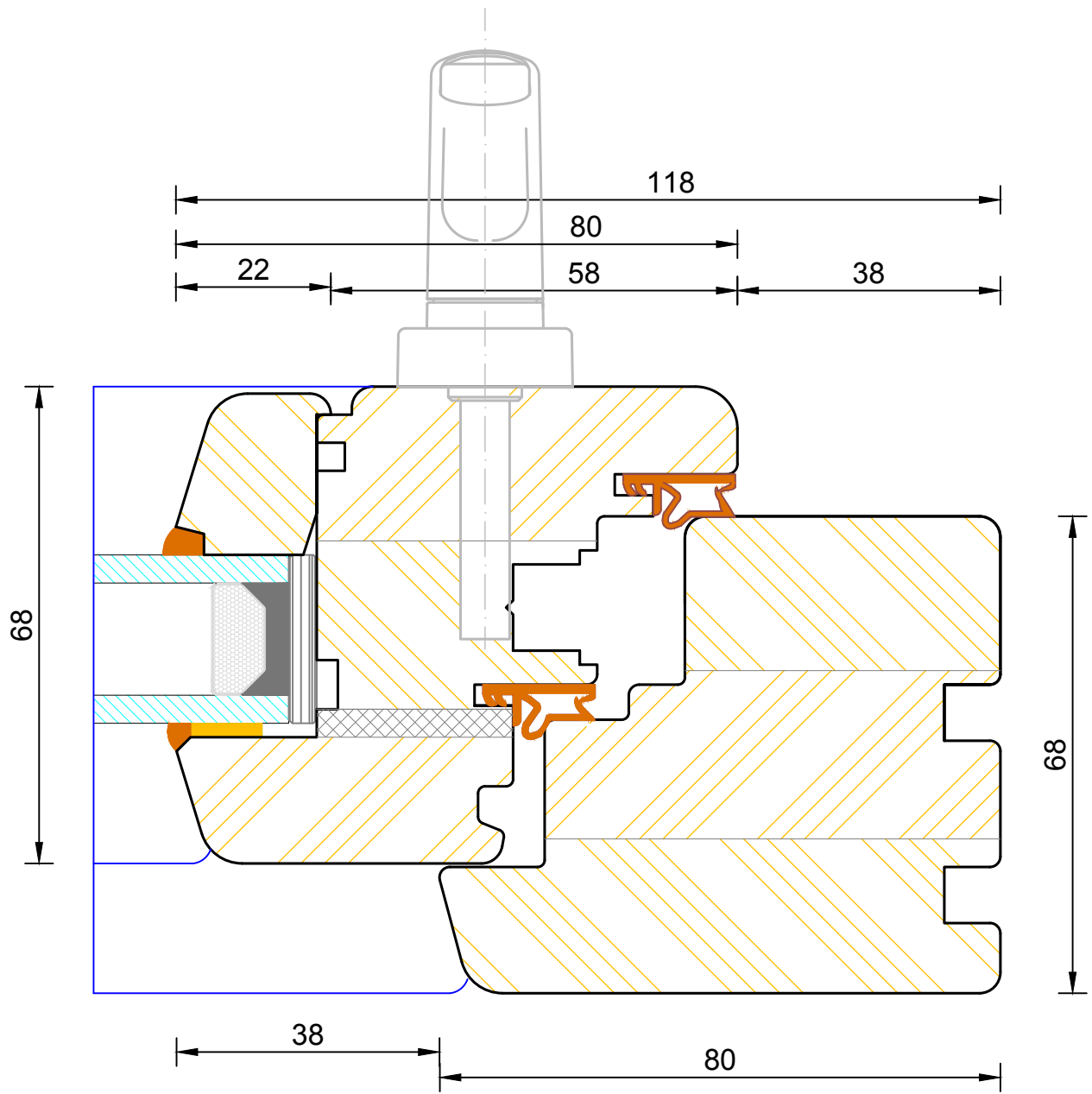

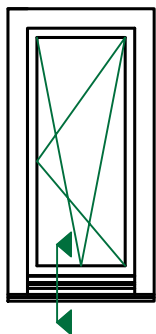
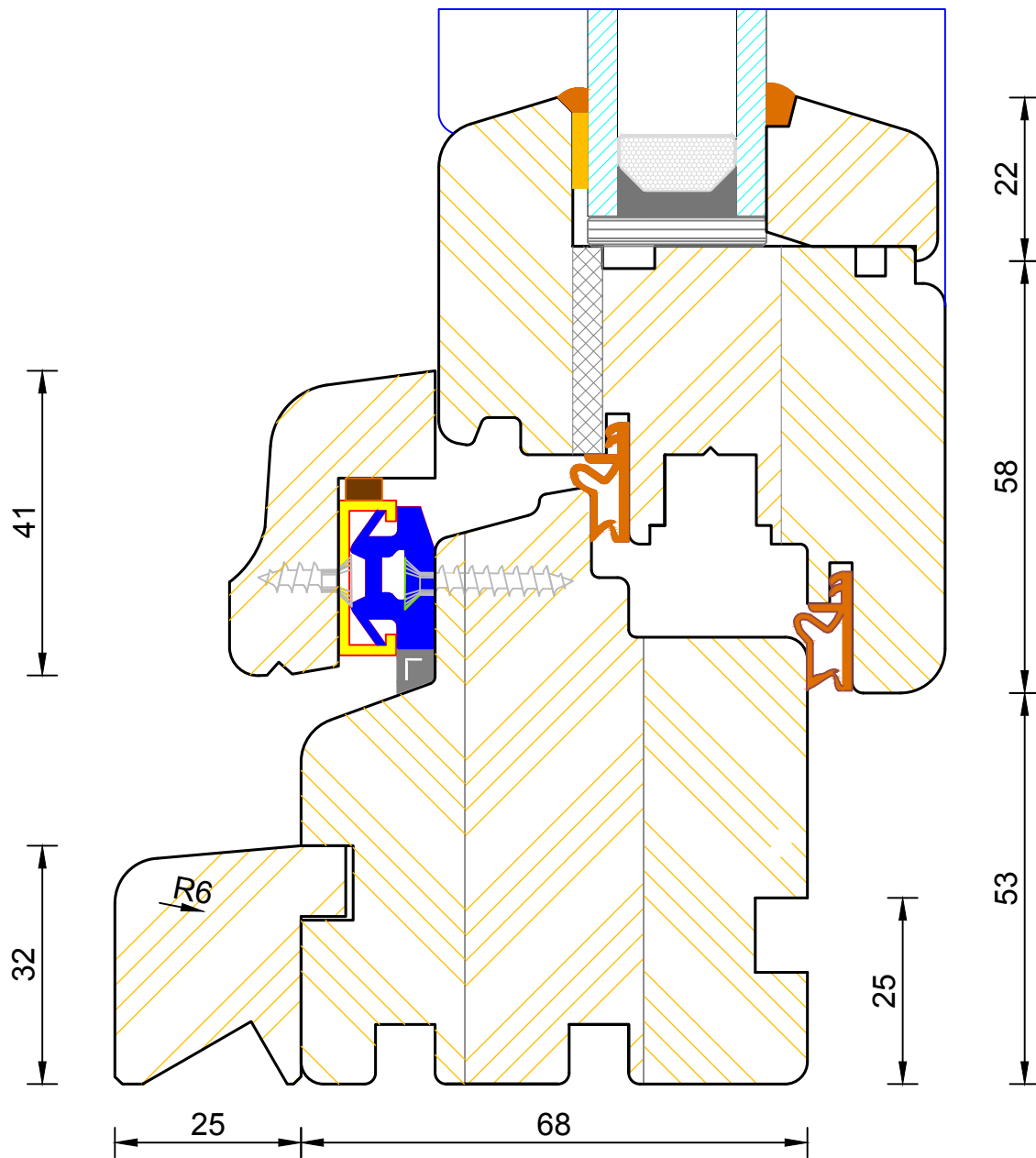

CILL EXTENSION - available options:
 25mm (93mm o/a) / 47mm (115mm o/a)
 / 62mm (130mm o/a) / 87mm (155mm
 o/a) / 114mm (182mm o/a) / 125mm
 (193mm o/a) / 140mm (208mm o/a)

FOR BALCONY DOORS OPTION WITH
TIMBER PLANT ON IS NOT
RECOMMENDED AND SHOULD BE
AVOIDED. IT CAN BE MANUFACTURED
ONLY WITHOUT WARRANTY

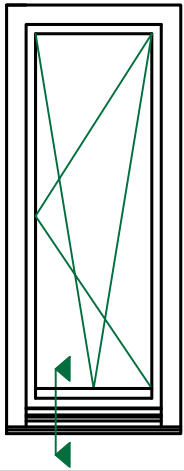
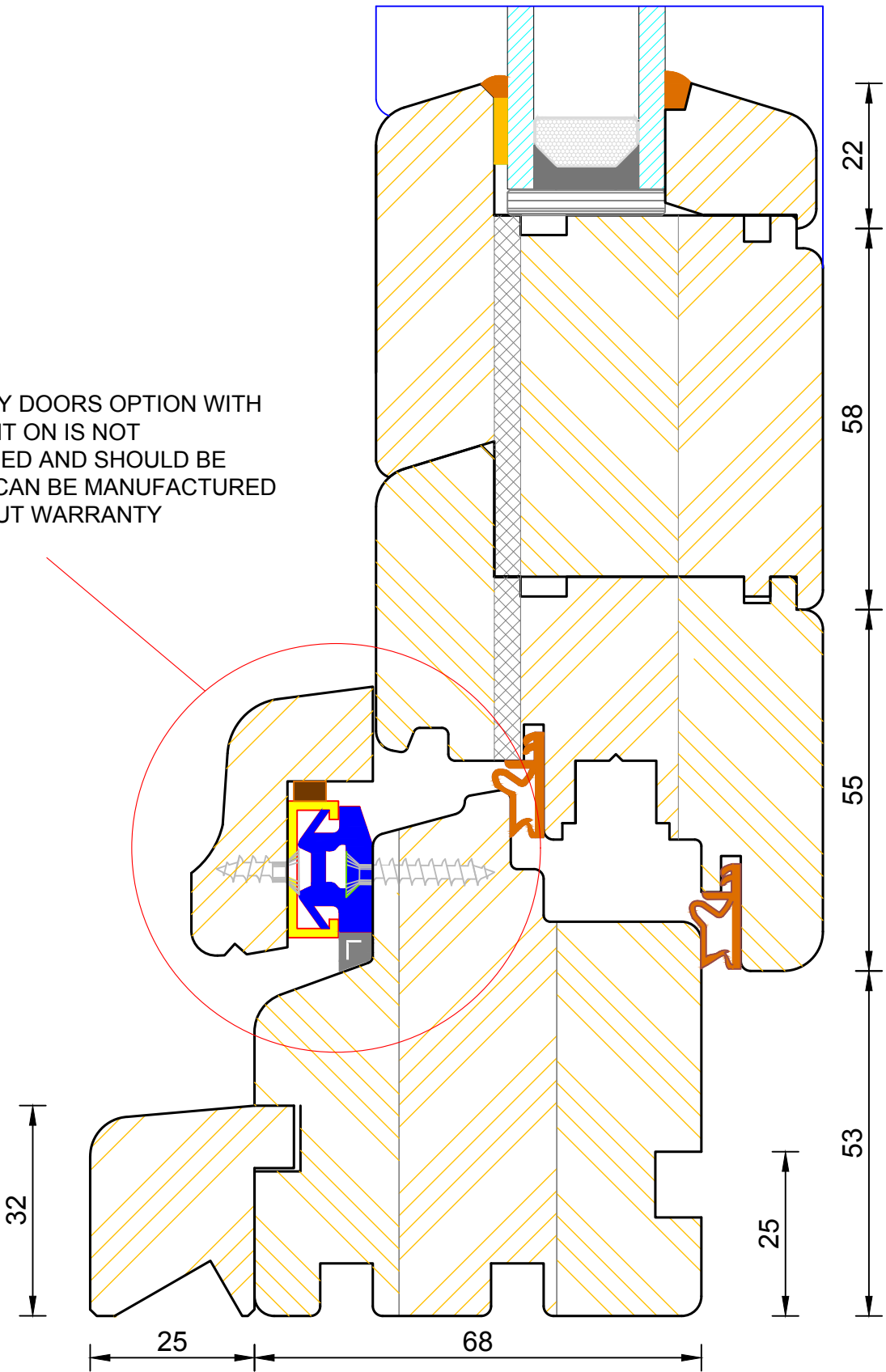

CILL EXTENSION - available options:

25mm (93mm o/a) / 47mm (115mm o/a) / 62mm (130mm o/a) /
87mm (155mm o/a) / 114mm (182mm o/a) / 125mm (193mm o/a) /
140mm (208mm o/a)



Bereco

**Contemporary Tilt & Turn Window
Frame & Sash Cill (Balcony Door)**

DIMENSIONS	PLOT SIZE	SCALE	DATE	REV	DWG NO.
MM	A4	1:1	22.03.2011	A	0017

Please consider the environment before printing

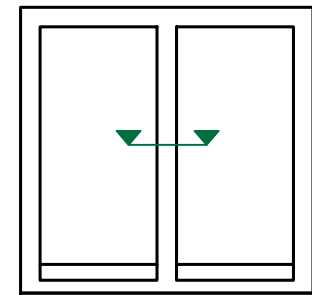
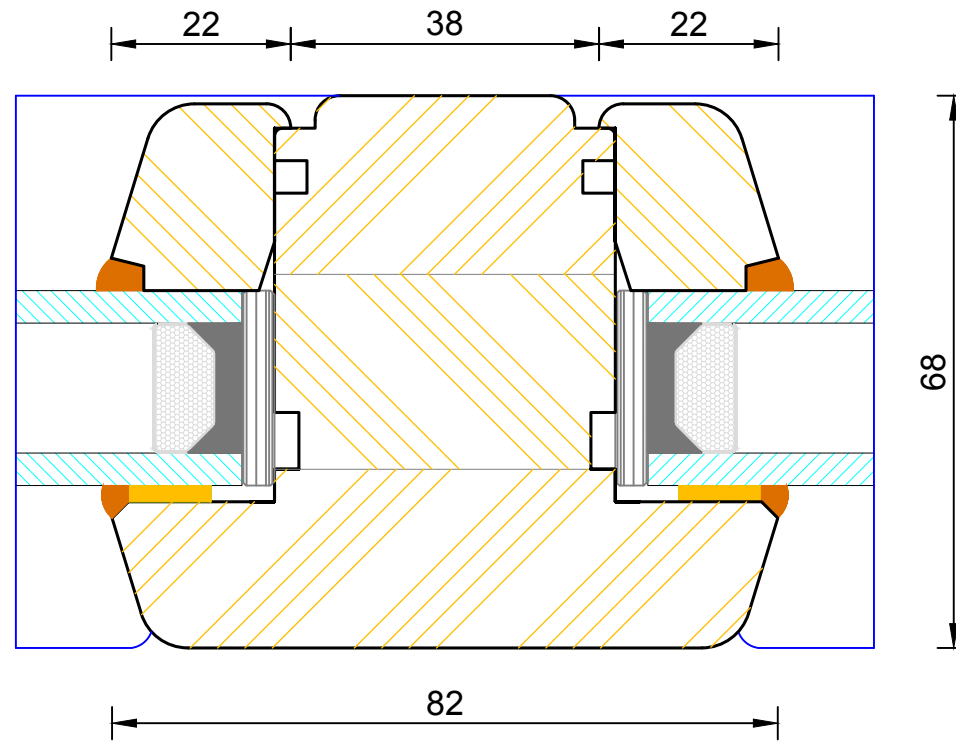

**Contemporary Tilt & Turn Window
Solid Mullion (Fixed Light / Fixed Light)**

DIMENSIONS	PLOT SIZE	SCALE	DATE	REV	DWG NO.
MM	A4	1:1	13.01.2011	A	0018
Please consider the environment before printing					

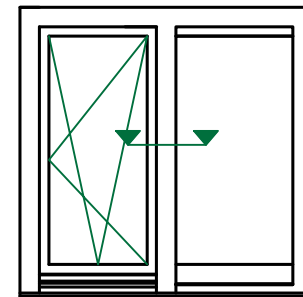
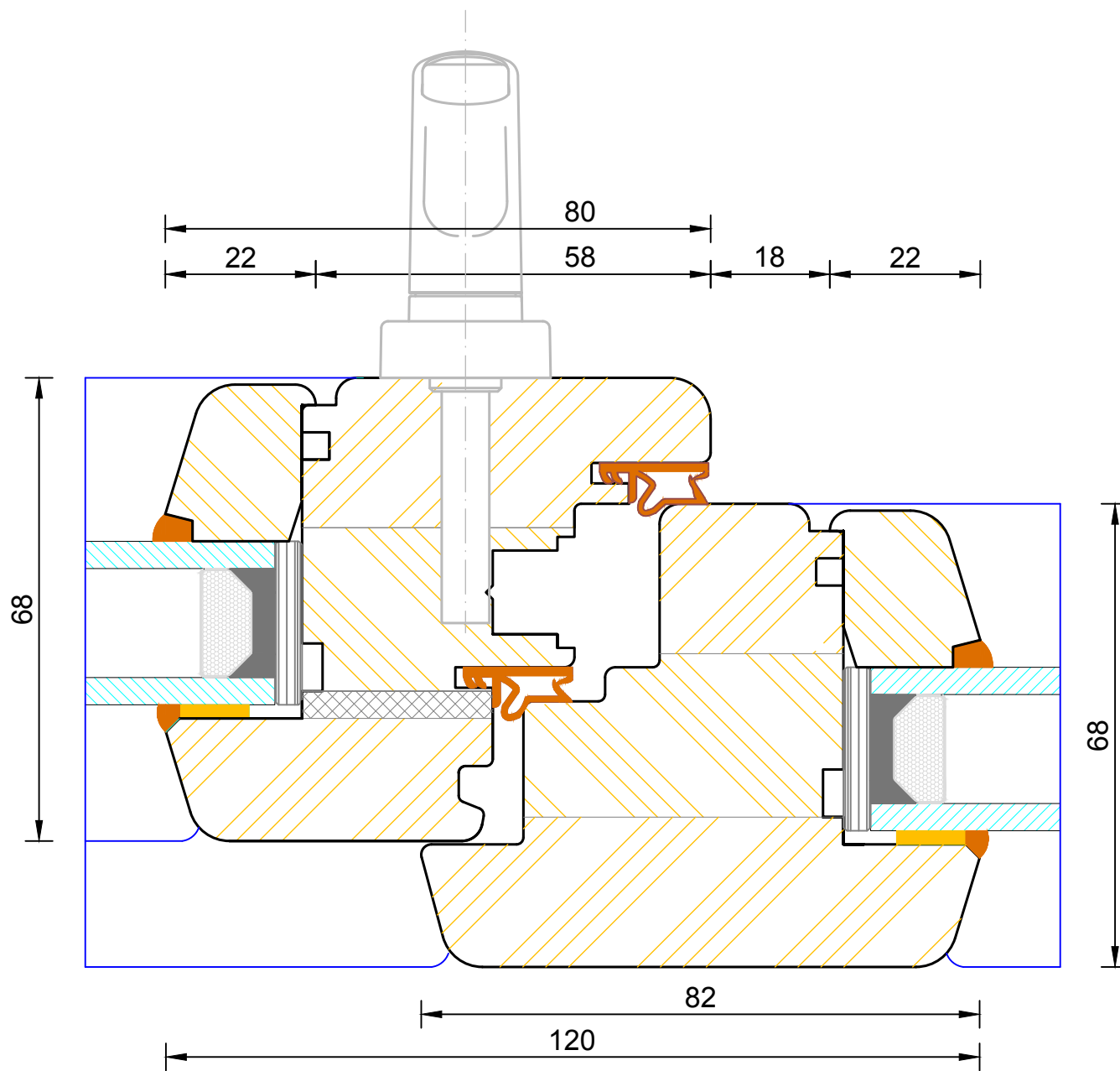

Contemporary Tilt & Turn Window
Solid Mullion (Sash / Fixed Light)

DIMENSIONS	PLOT SIZE	SCALE	DATE	REV	DWG NO.
MM	A4	1:1	13.01.2011	A	0019
Please consider the environment before printing					

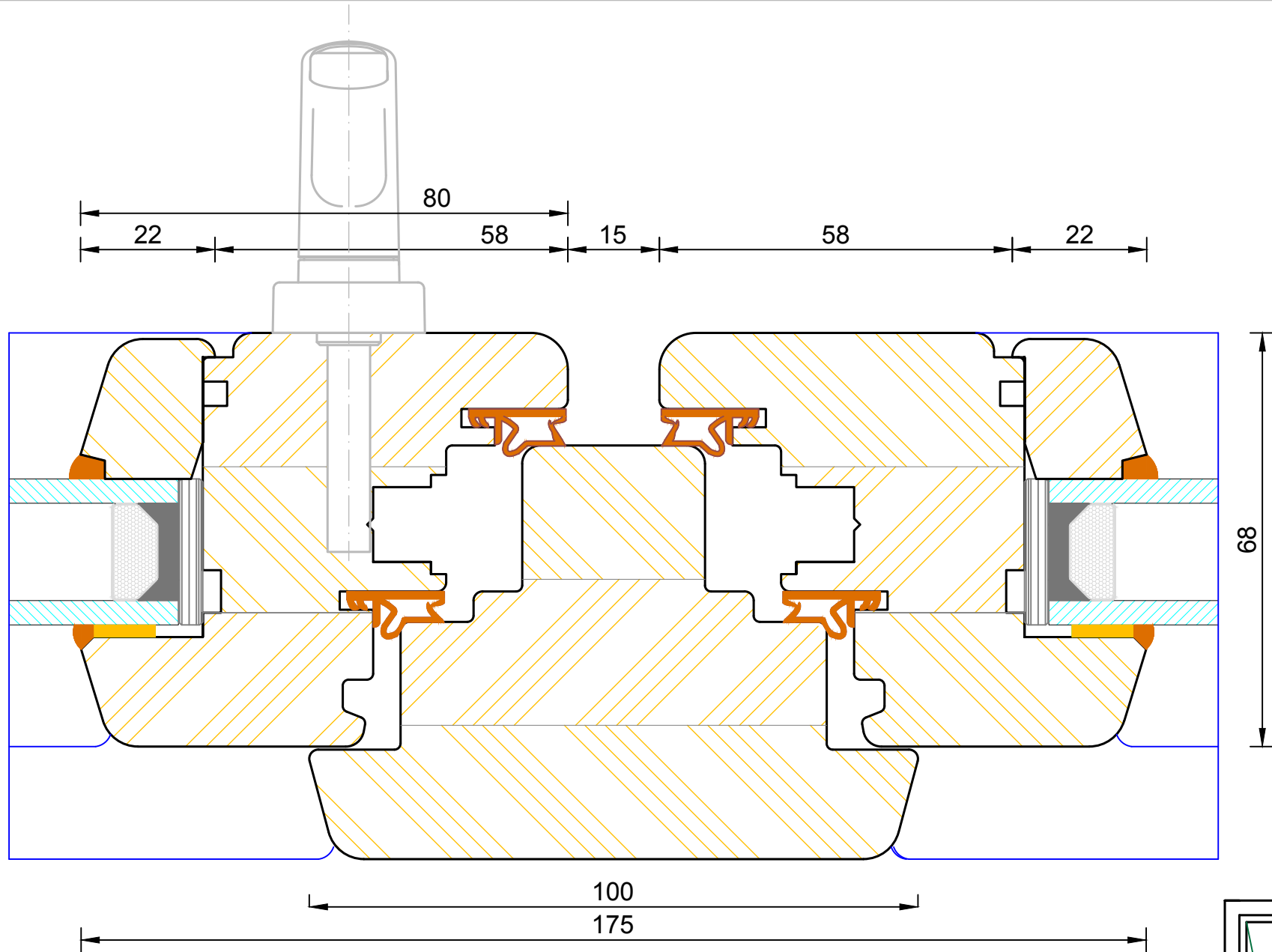

**Contemporary Tilt & Turn Window
Solid Mullion (Sash / Fixed Sash)**

DIMENSIONS	PLOT SIZE	SCALE	DATE	REV	DWG NO.
MM	A4	1:1	13.01.2011	A	0020
Please consider the environment before printing					

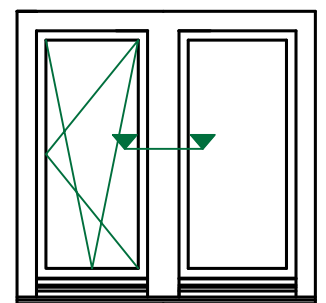

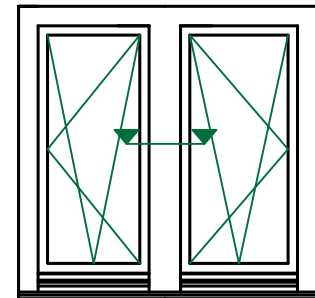
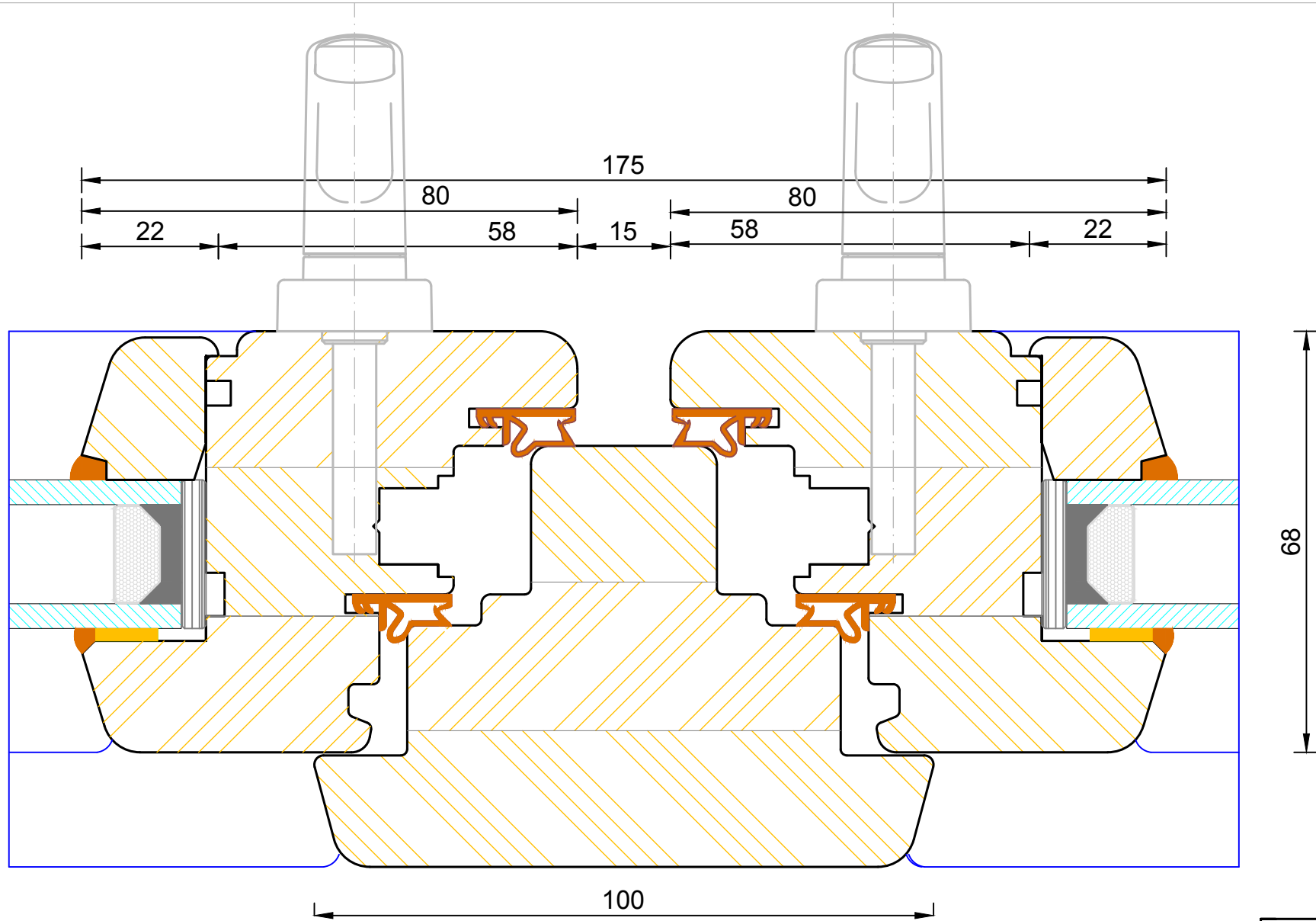

**Contemporary Tilt & Turn Window
Solid Mullion (Fixed Sash / Sash)**

DIMENSIONS	PLOT SIZE	SCALE	DATE	REV	DWG NO.
MM	A4	1:1	13.01.2011	A	0021

Please consider the environment before printing

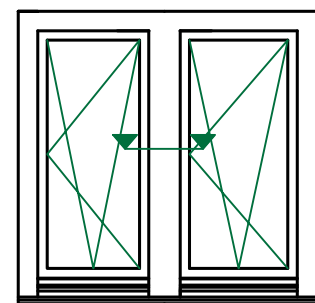
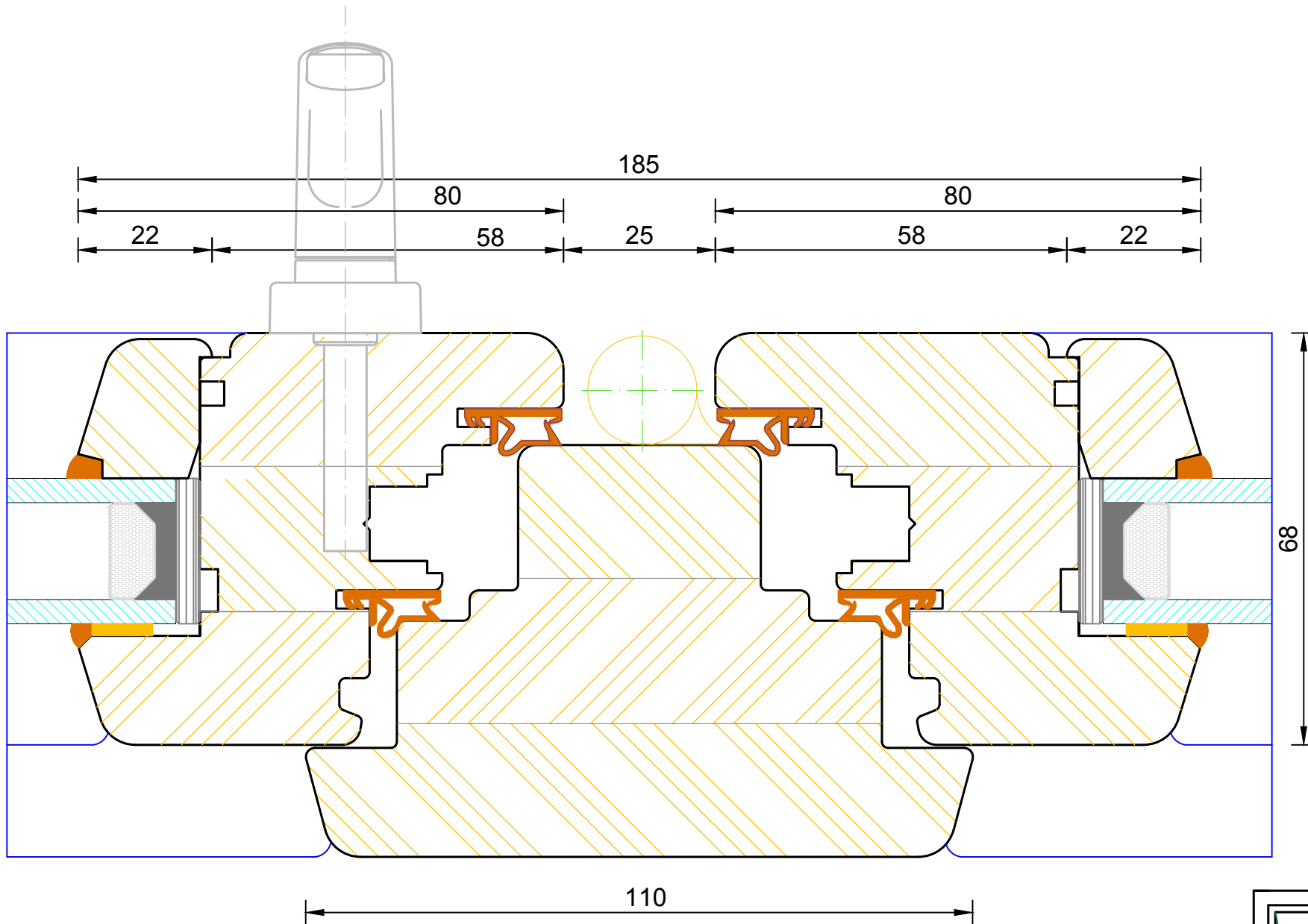

**Contemporary Tilt & Turn Window
Solid Mullion (Sash / Sash)**

DIMENSIONS	PLOT SIZE	SCALE	DATE	REV	DWG NO.
MM	A4	1:1	13.01.2011	A	0022
Please consider the environment before printing					

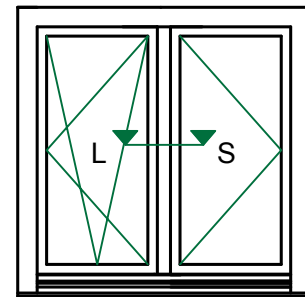
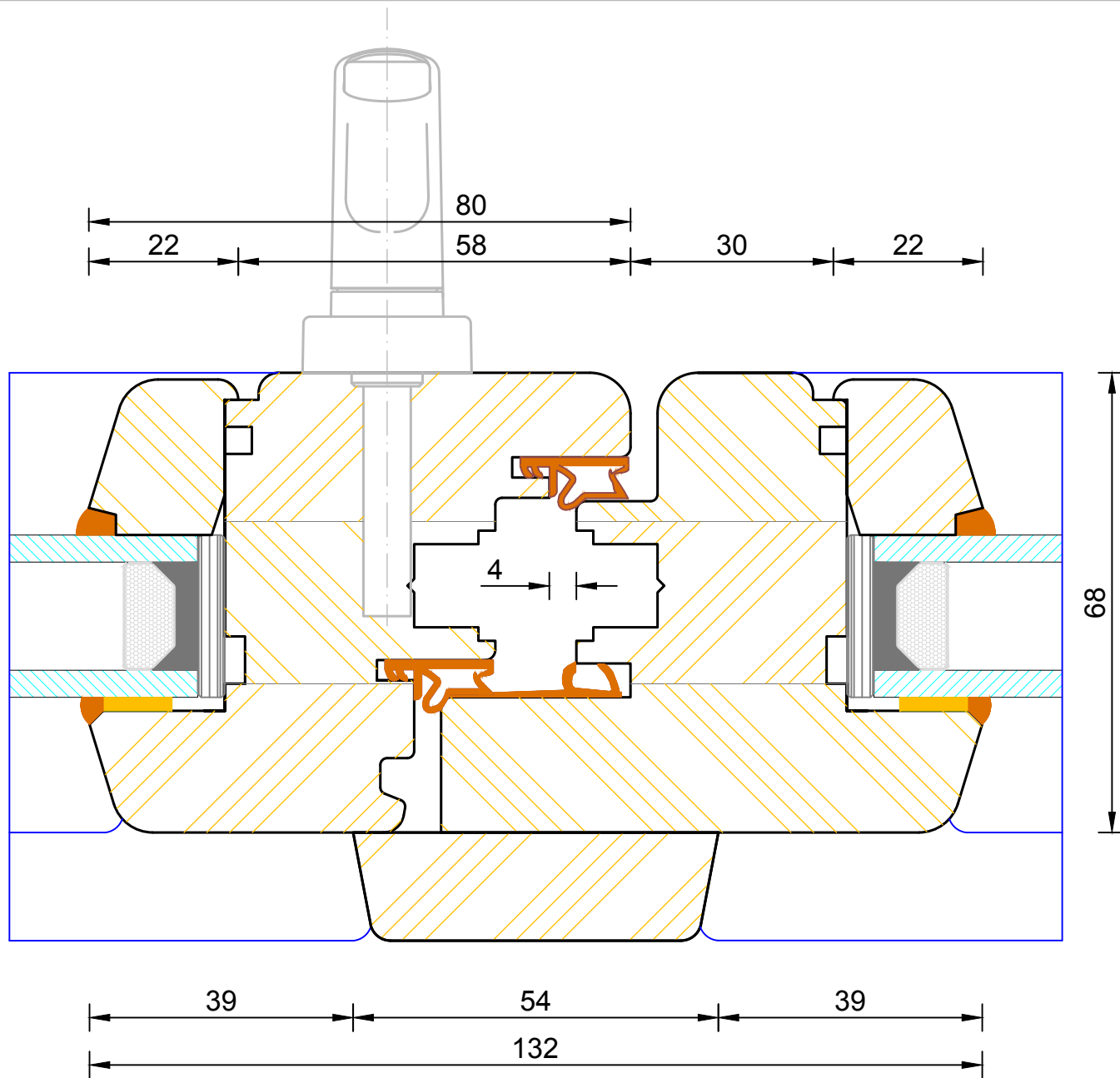

Contemporary Tilt & Turn Window
 Flying Mullion (Lead / Slave Sash)

DIMENSIONS	PLOT SIZE	SCALE	DATE	REV	DWG NO.
MM	A4	1:1	13.01.2011	A	0023
Please consider the environment before printing					

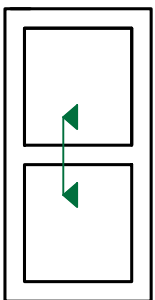
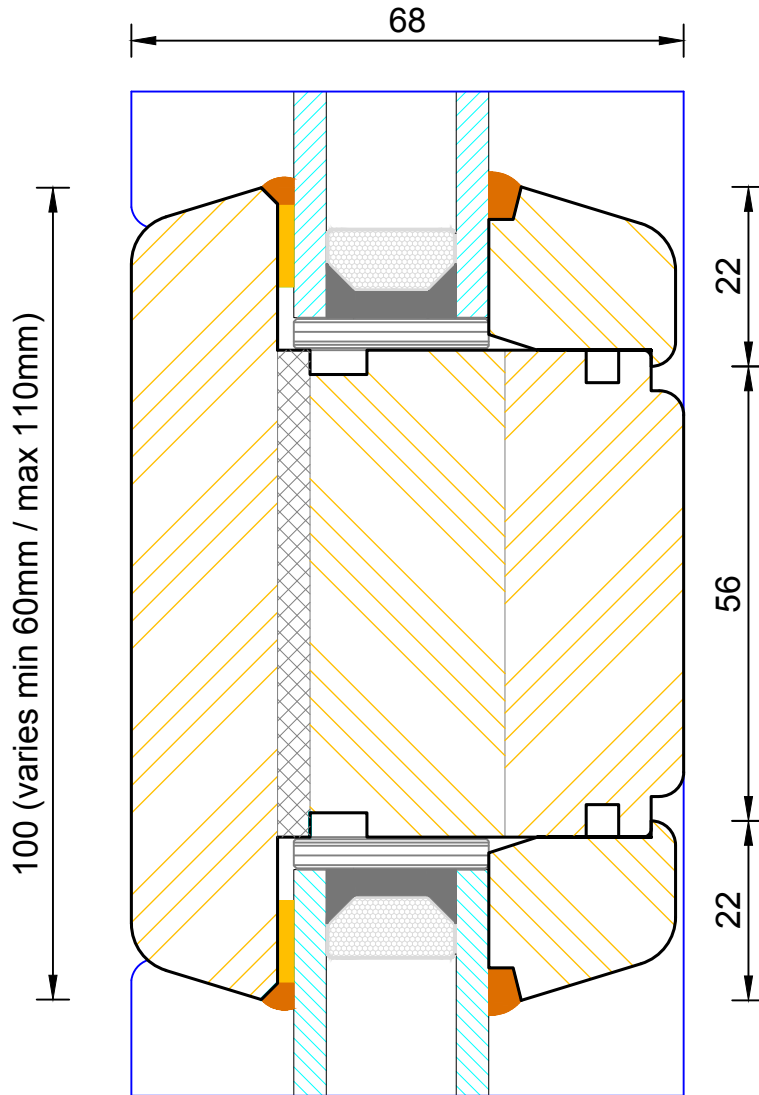

DIMENSIONS	PLOT SIZE	SCALE	DATE	REV	DWG NO.
MM	A4	1:1	22.03.2011	A	0024
Please consider the environment before printing					

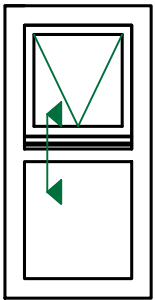
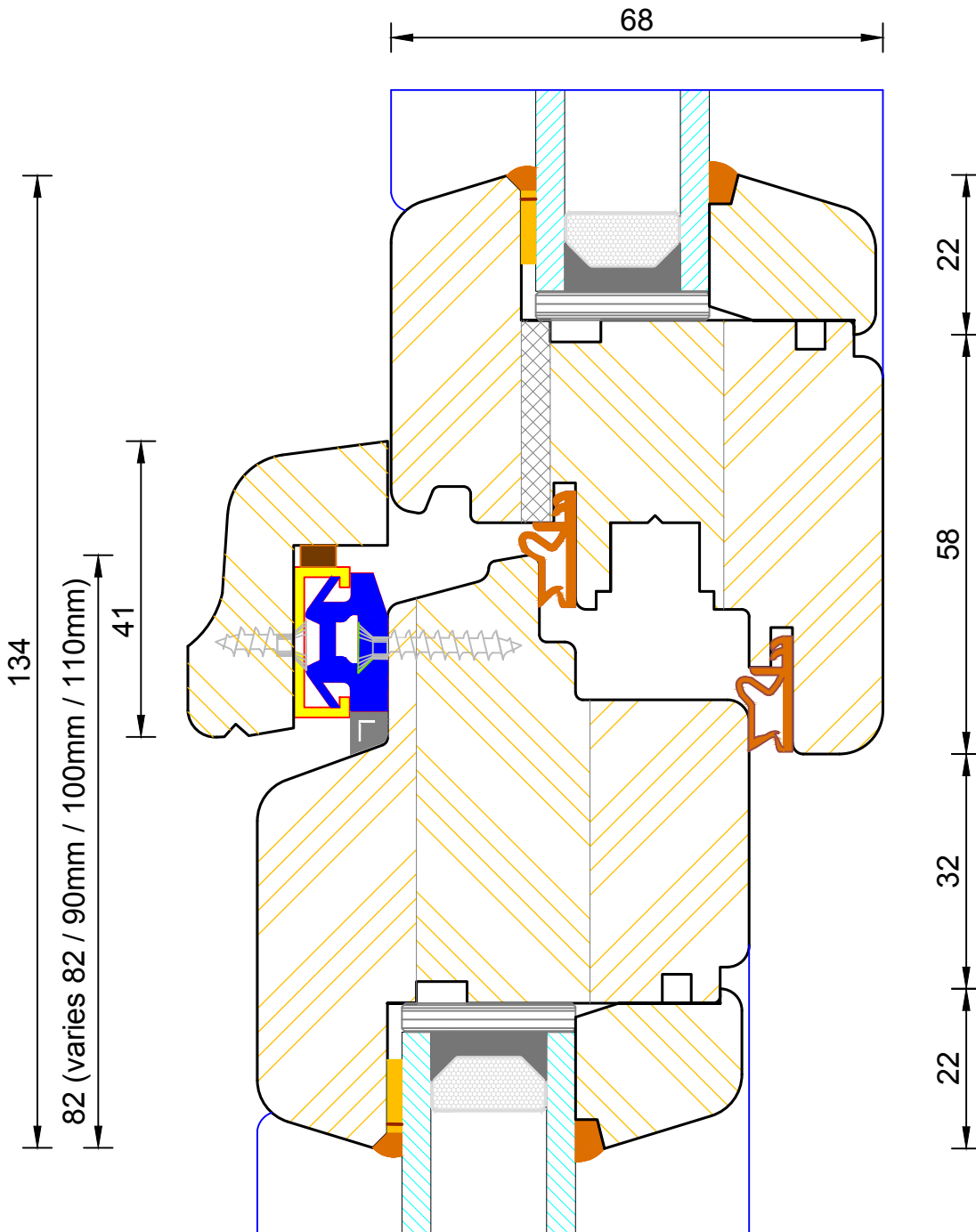

DIMENSIONS	PLOT SIZE	SCALE	DATE	REV	DWG NO.
MM	A4	1:1	22.03.2011	A	0025

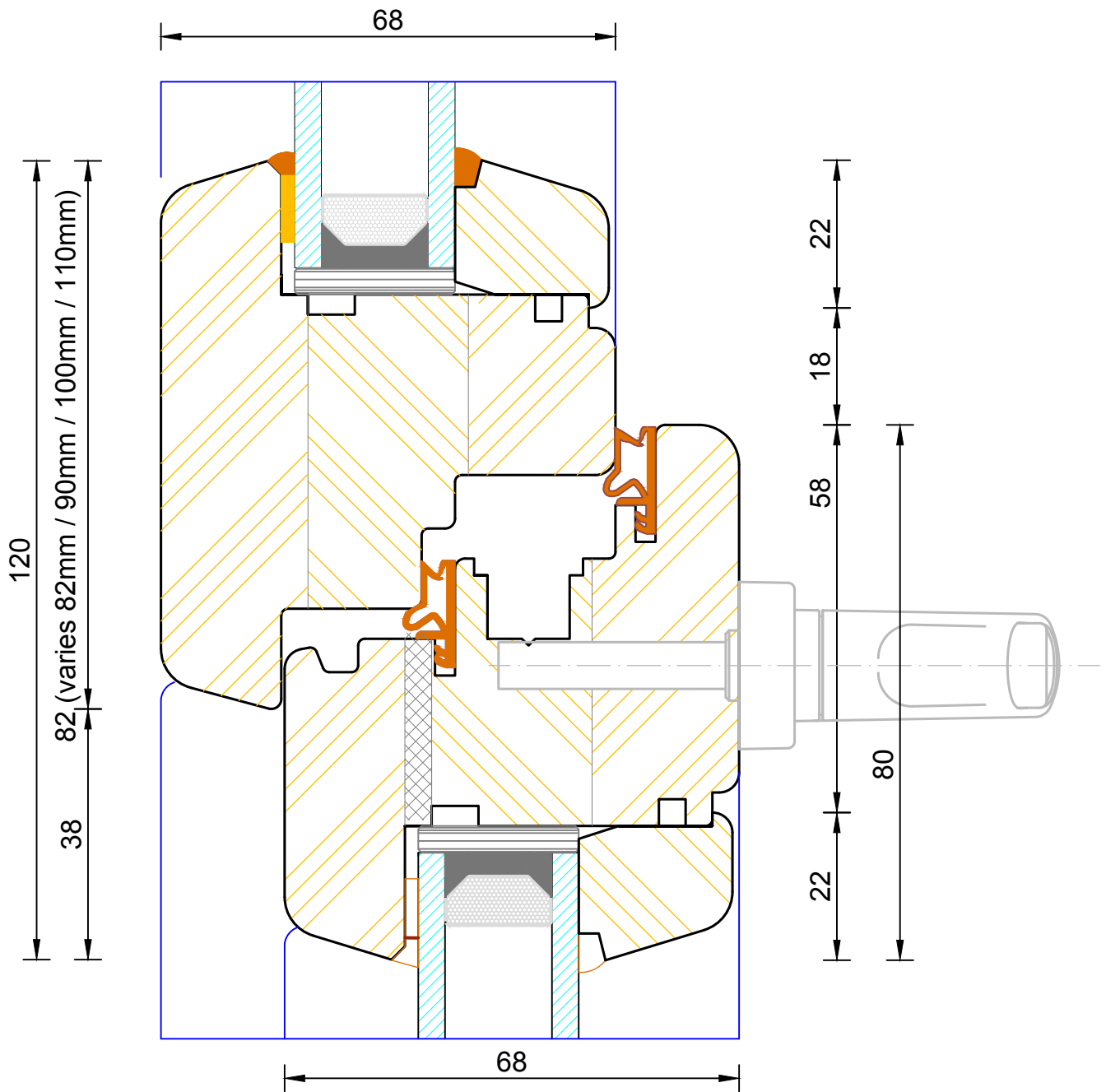

**Contemporary Tilt & Turn Window
Solid Transom (Fixed Light / Sash)**

DIMENSIONS	PLOT SIZE	SCALE	DATE	REV	DWG NO.
MM	A4	1:1	22.03.2011	A	0026
Please consider the environment before printing					

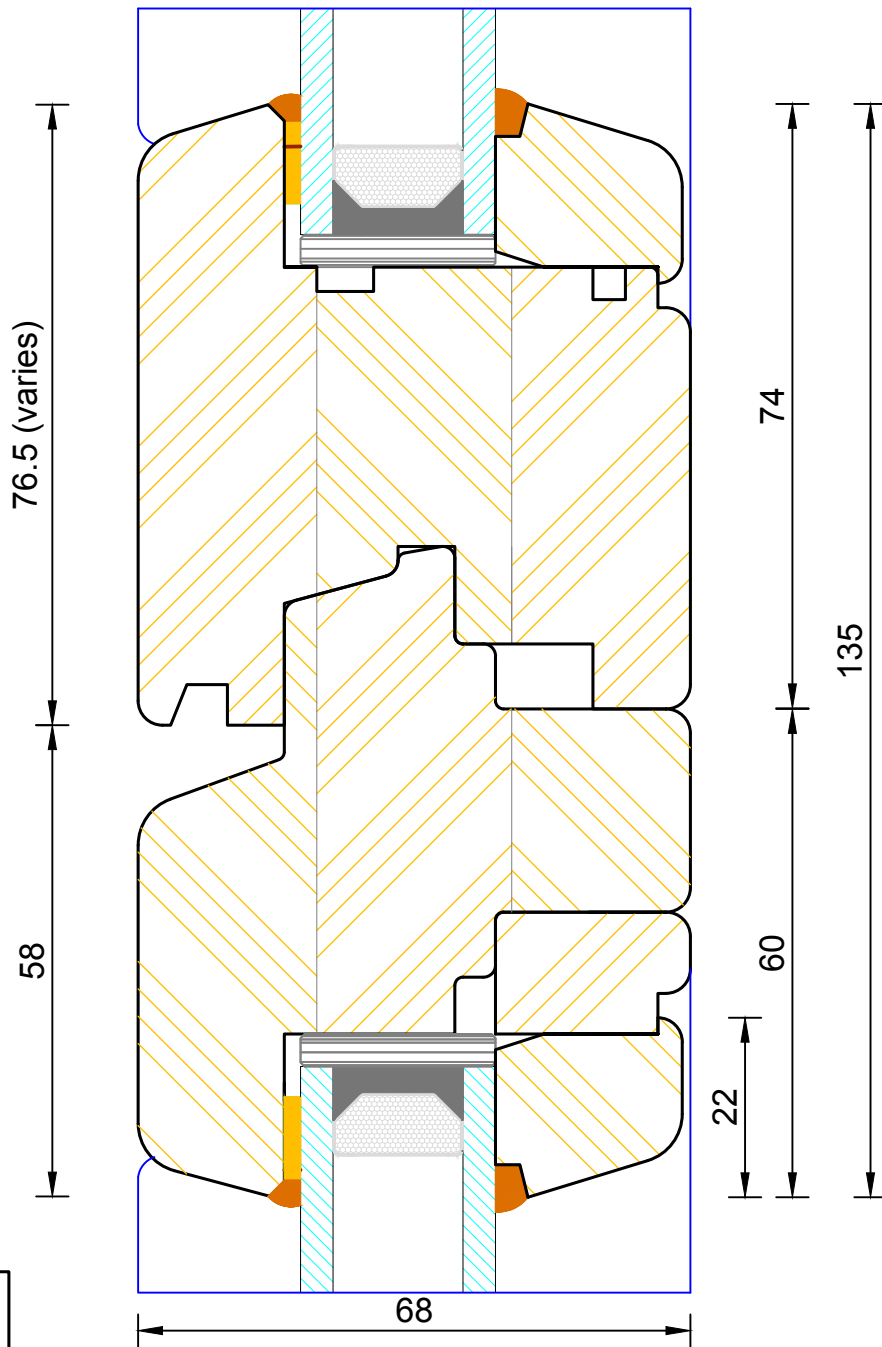
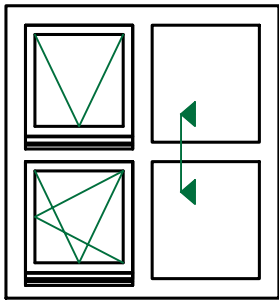

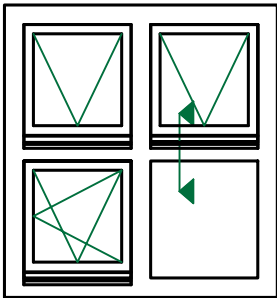
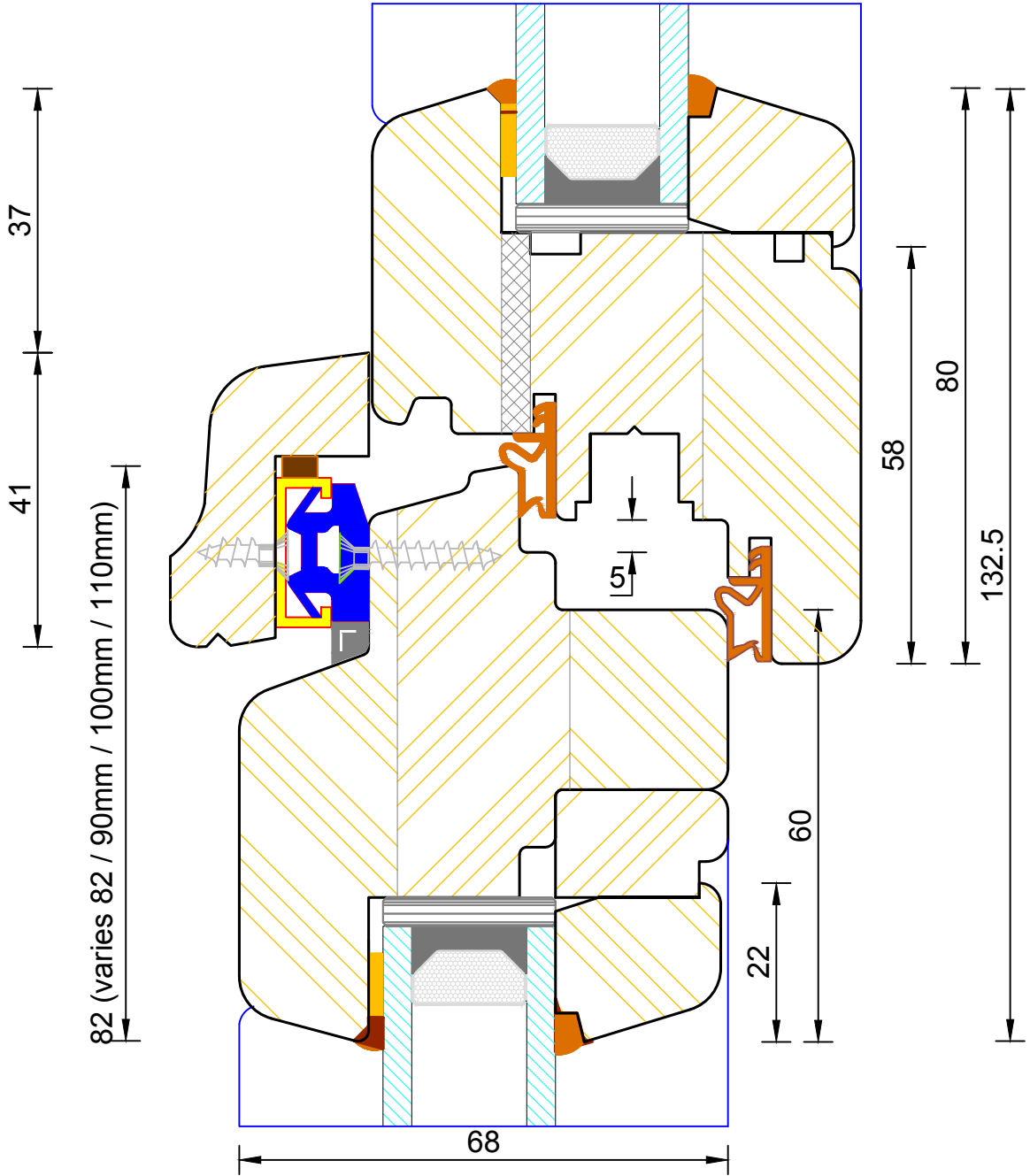

DIMENSIONS	PLOT SIZE	SCALE	DATE	REV	DWG NO.
MM	A4	1:1	22.03.2011	A	0029

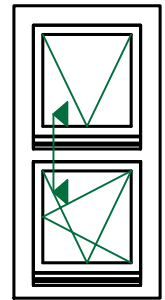
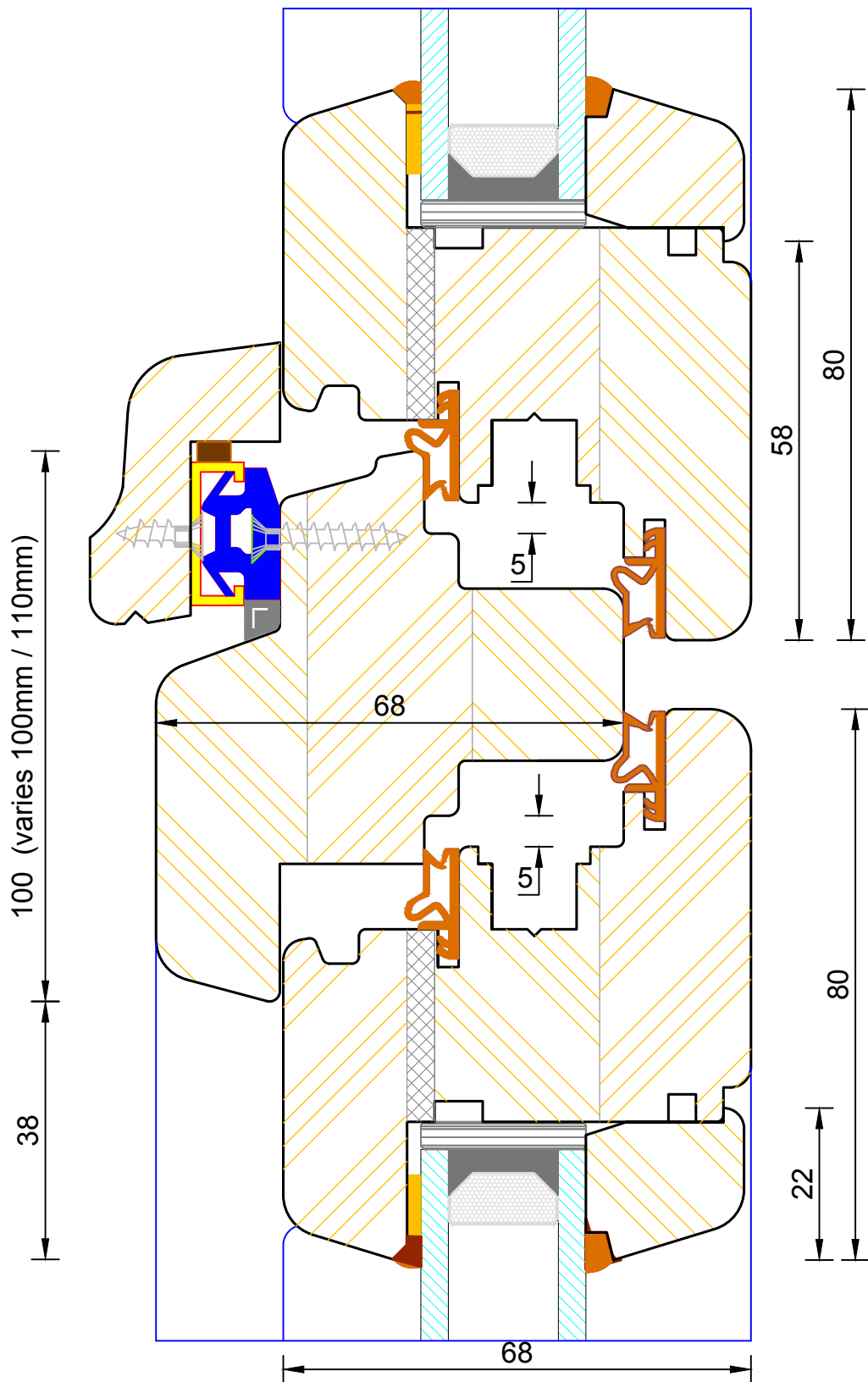

Contemporary Tilt & Turn Window Solid Transom (Sash / Sash)

DIMENSIONS	PLOT SIZE	SCALE	DATE	REV	DWG NO.
MM	A4	1:1	22.03.2011	A	0030

Please consider the environment before printing