

Contemporary Open In Flush French Door
Triple Glazed - Cill Extension Options

DIMENSIONS	PLOT SIZE	SCALE	DATE	REV	DWG NO.
MM	A4	1:1	25.09.2019	B	0651

Please consider the environment before printing

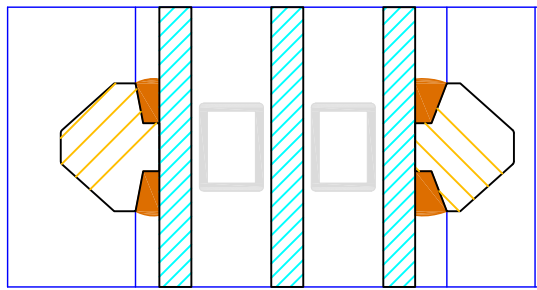

16

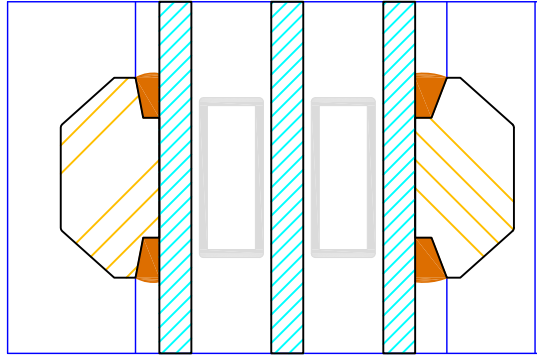

25

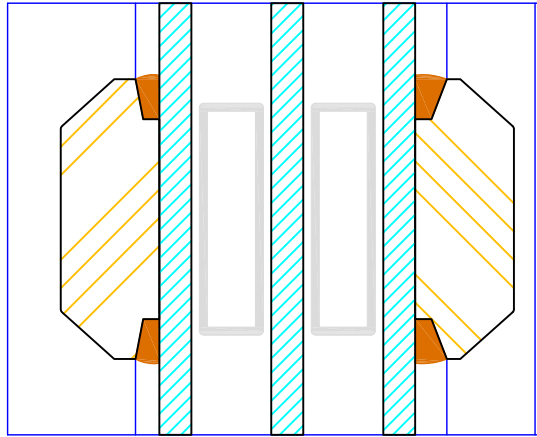

35

60 (varies min 60 / max 110mm)

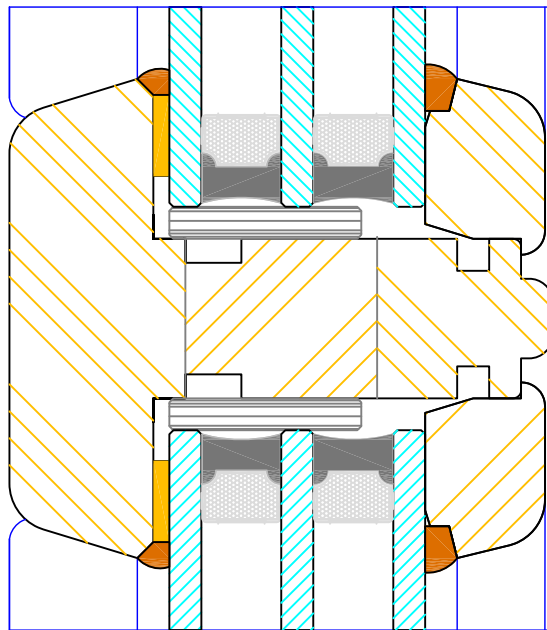

22

16

22

68



Contemporary Open In Flush French Door
Triple Glazed - Bar Options

DIMENSIONS	PLOT SIZE	SCALE	DATE	REV	DWG NO.
MM	A4	1:1	27.01.2011	A	0652

Please consider the environment before printing

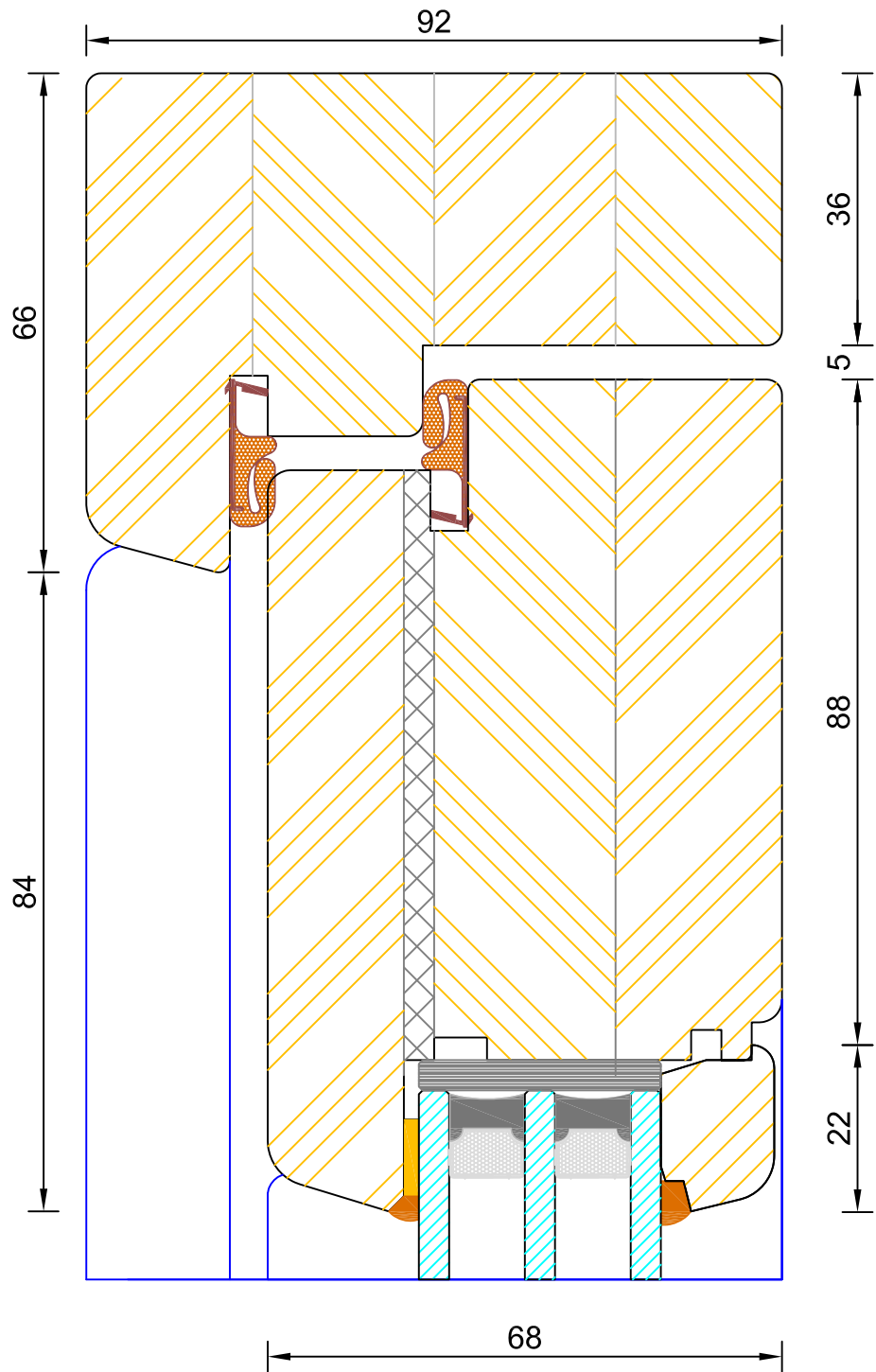
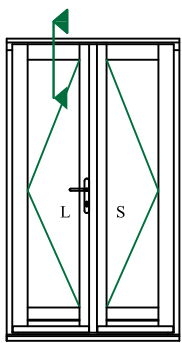

Contemporary Open In Flush Entrance Door
Triple Glazed - Frame & Leaf Head

DIMENSIONS	PLOT SIZE	SCALE	DATE	REV	DWG NO.
MM	A4	1:1	27.01.2011	A	0653

Please consider the environment before printing

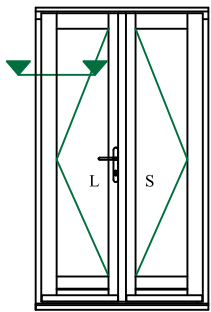
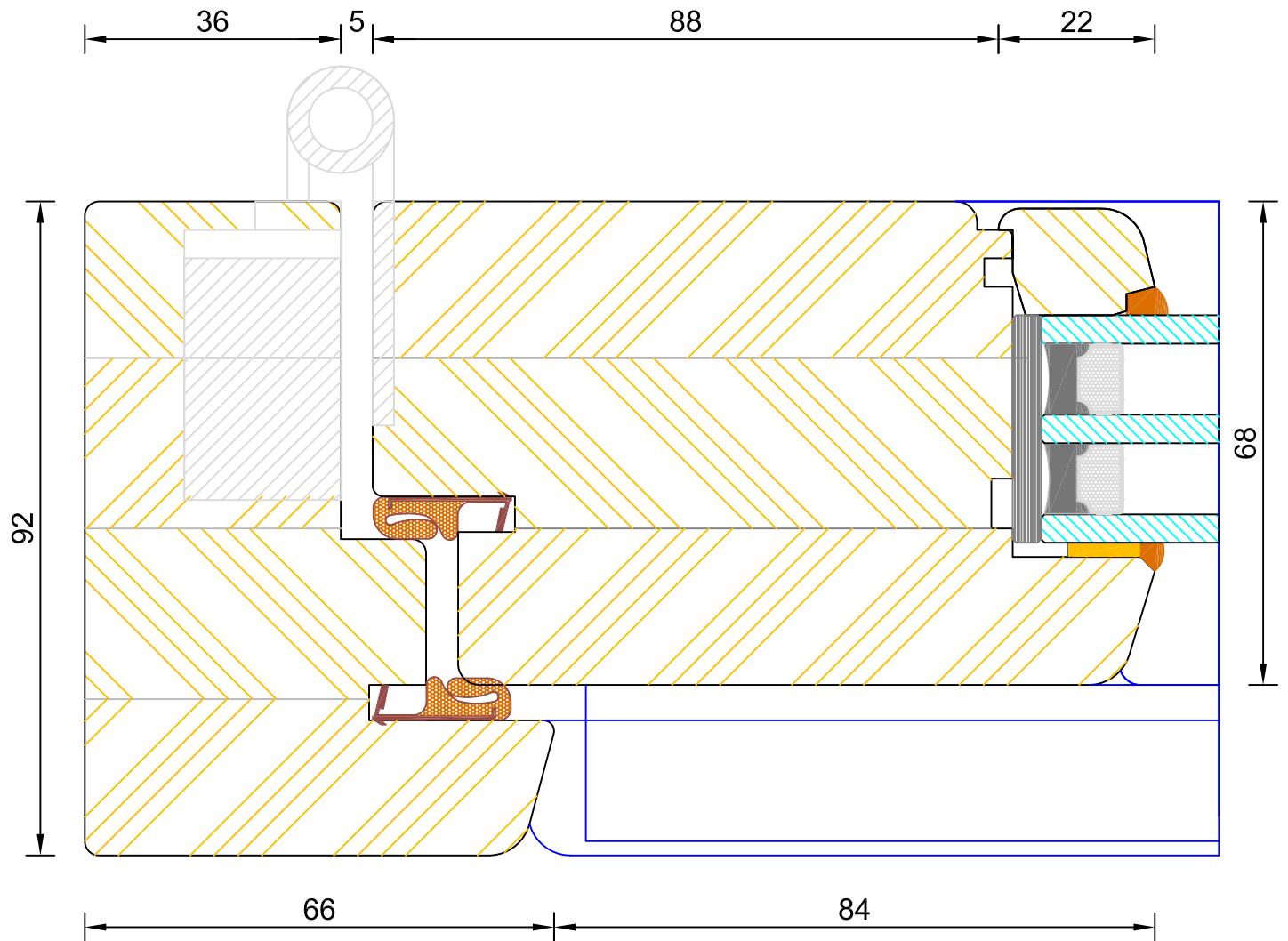

Contemporary Open In Flush Entrance Door
Triple Glazed - Frame & Leaf Jamb (Hinge Side)

DIMENSIONS	PLOT SIZE	SCALE	DATE	REV	DWG NO.
MM	A4	1:1	27.01.2011	A	0654

Please consider the environment before printing

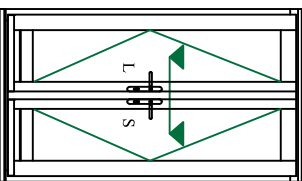
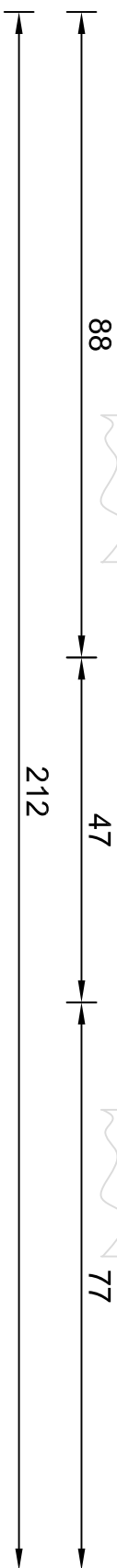
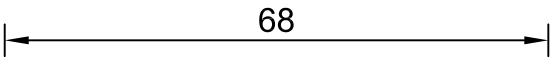
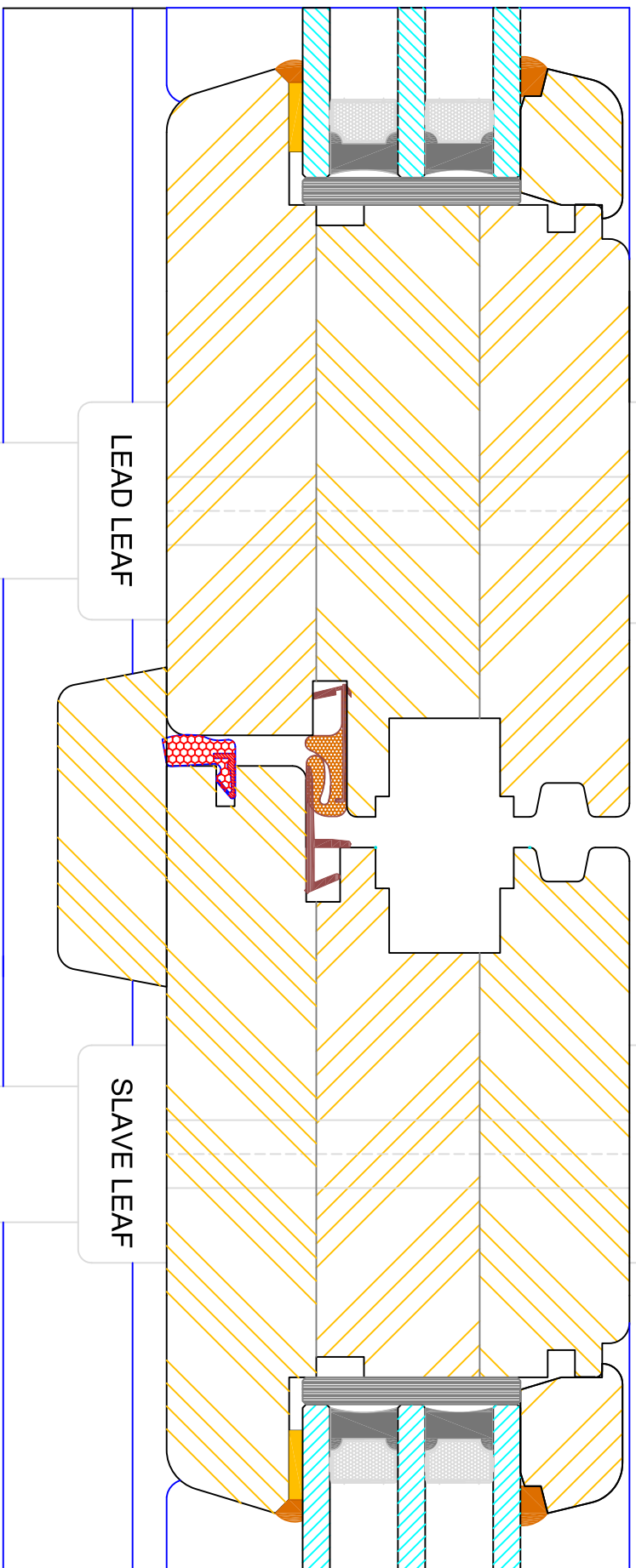
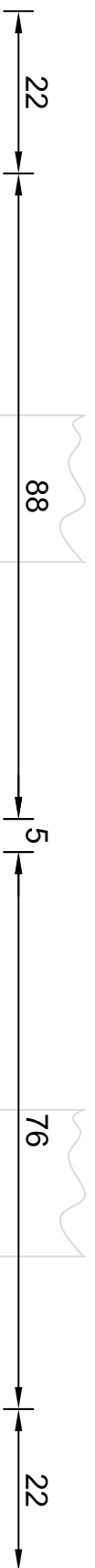

Contemporary Open In Flush French Door
Triple Glazed - Flying Mullion (Double Handle)

DIMENSIONS		PLOT SIZE	SCALE	DATE	REV	DWG NO.
MM	A4	A4	1:1	27.01.2011	A	0655

Please consider the environment before printing

Note: Used as standard on doors >2301mm high



Bereco

Contemporary Open In Flush French Door Triple Glazed - Flying Mullion (Single Handle)

DIMENSIONS	PLOT SIZE	SCALE	DATE	REV	DWG. NO.
MM	A4	1:1	27.01.2011	A	0656

Please consider the environment before printing

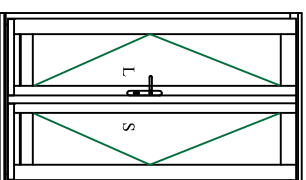
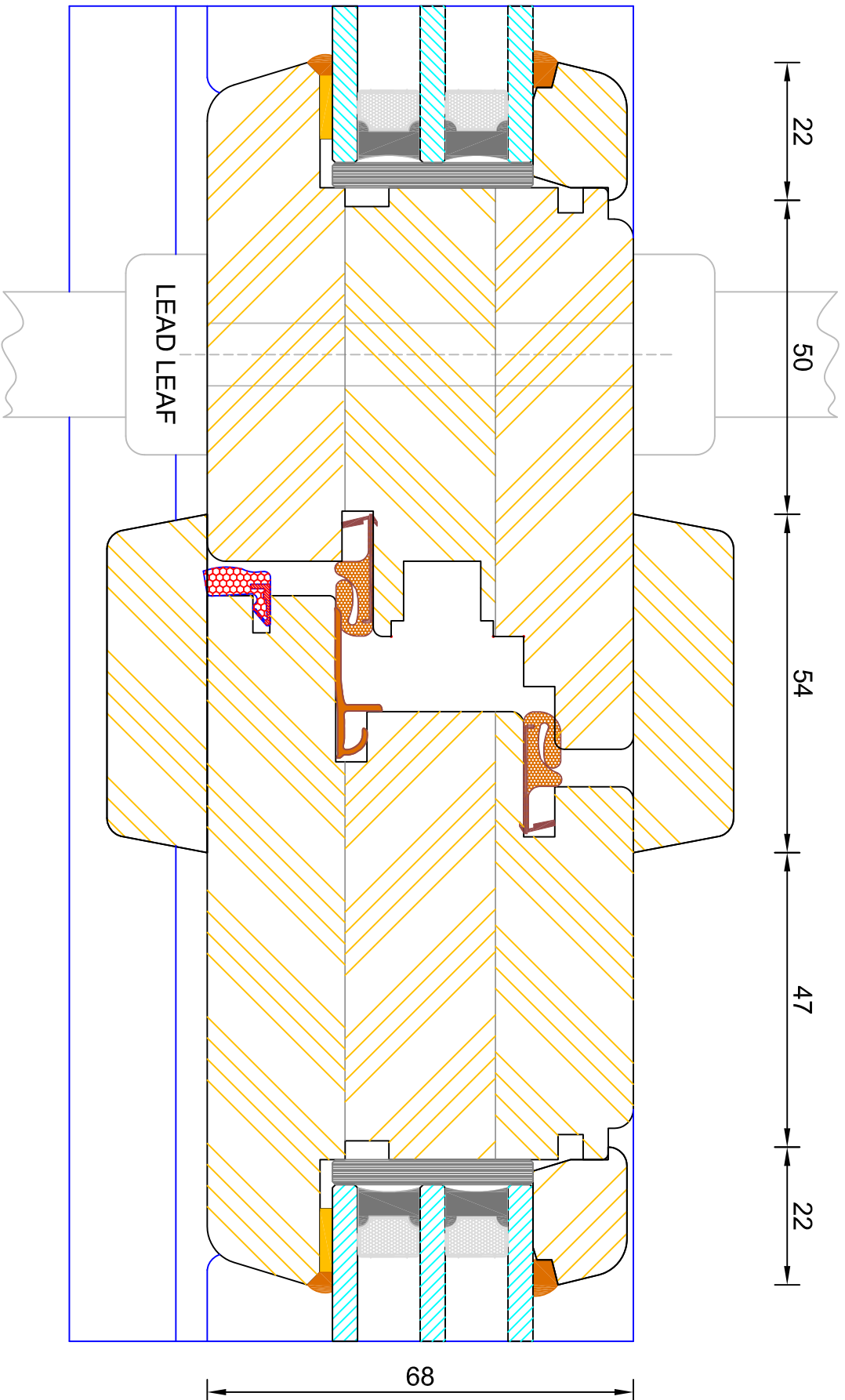

Note: Used as standard on doors <2300mm high unless otherwise specified

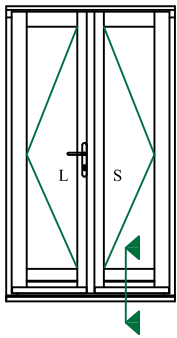
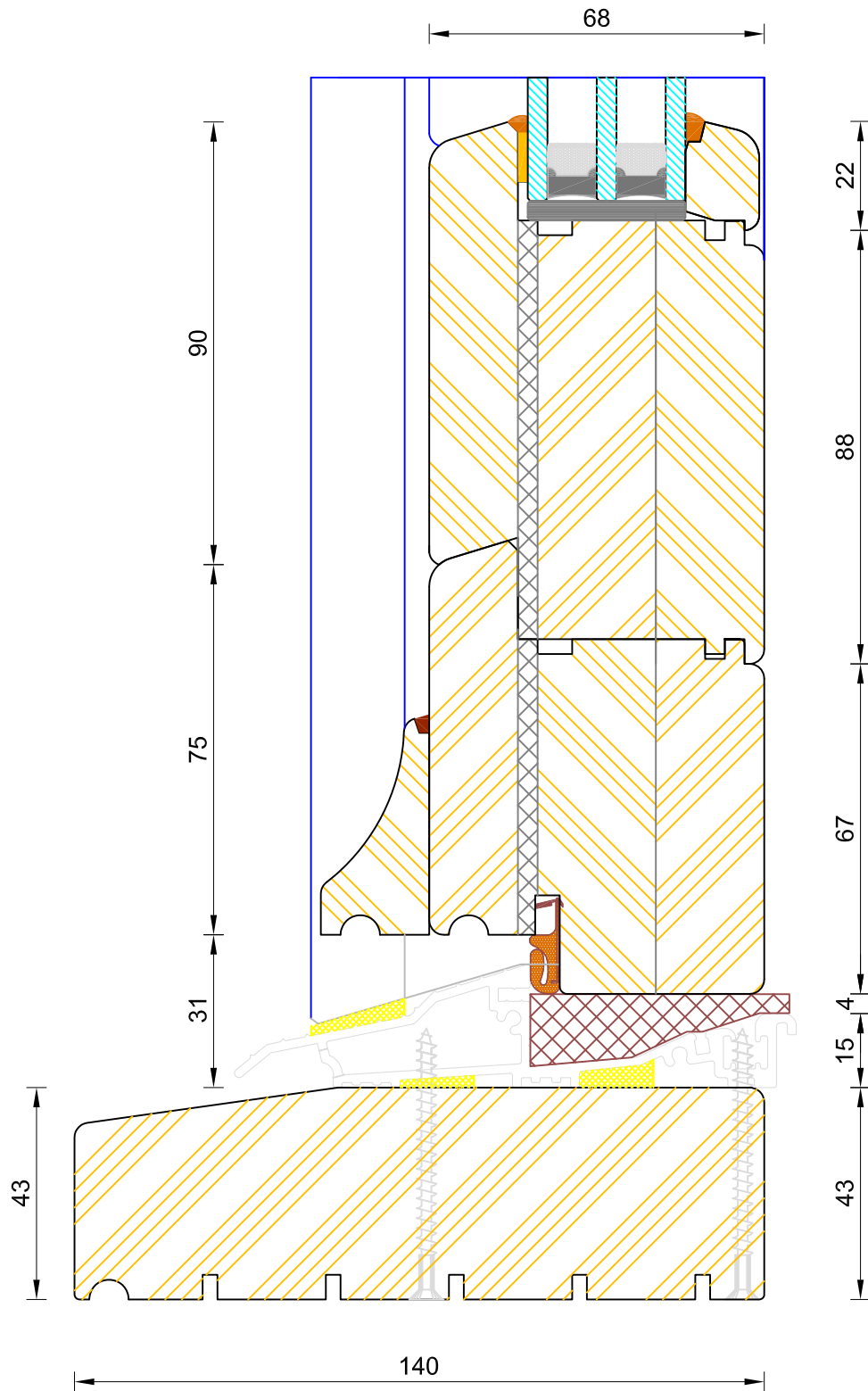

Contemporary Open In Flush French Door
 Triple Glazed - Standard Thresh (140x43mm)

DIMENSIONS	PLOT SIZE	SCALE	DATE	REV	DWG NO.
MM	A3	1:1	27.01.2011	A	0657

Please consider the environment before printing

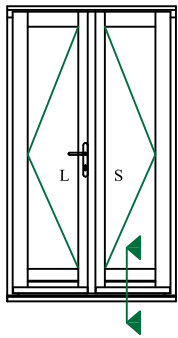
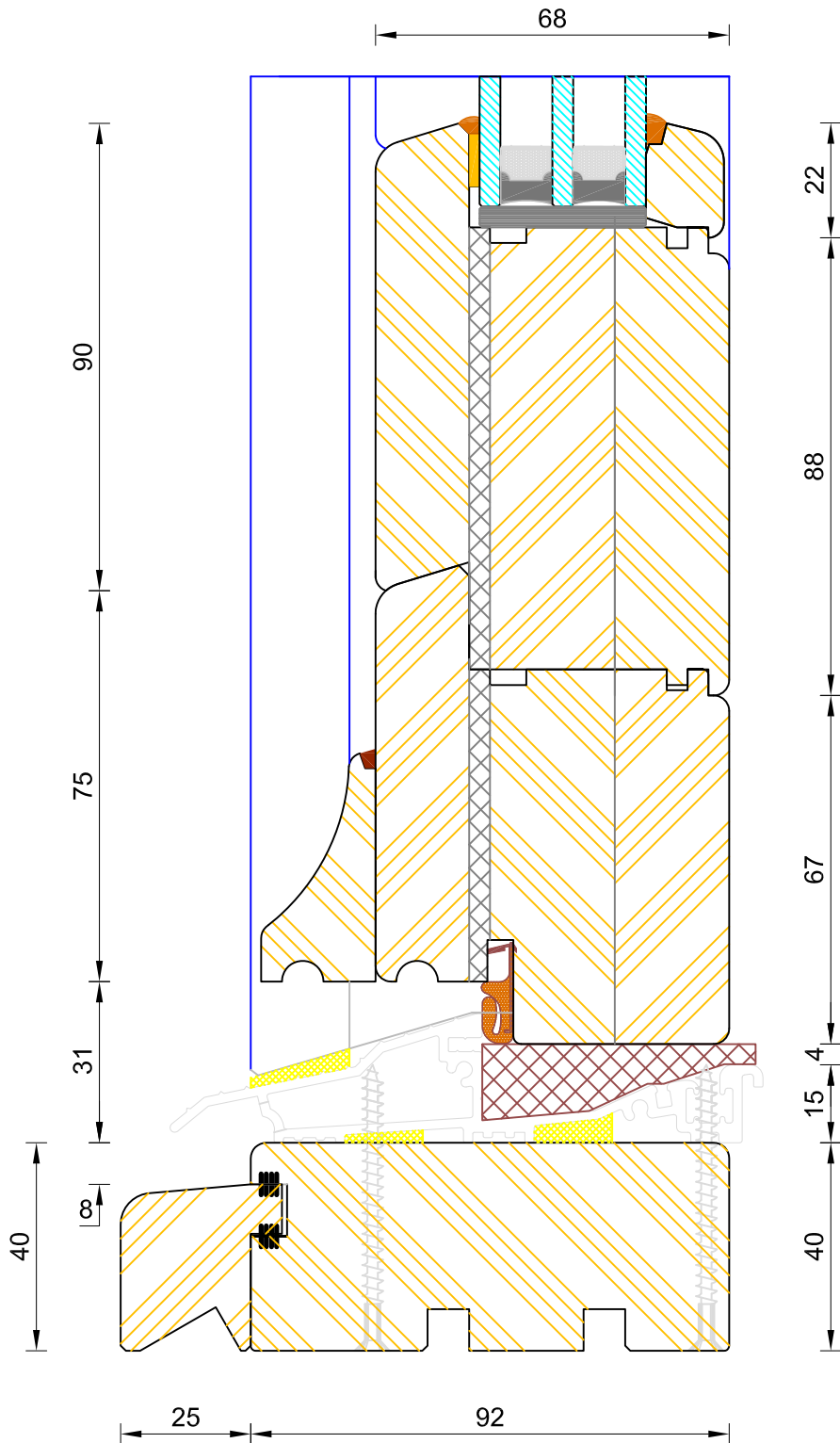

CILL EXTENSION - available options: 25mm (117mm o/a) / 47mm (139mm o/a) / 62mm (154mm o/a) / 87mm (179mm o/a) / 114mm (206mm o/a) / 125mm (217mm o/a) / 140mm (232mm o/a)

NOTE: Cill Extensions should be supported from underneath; the maximum overhang over Brick / Blockwork for cill extension should not exceed 25mm in order to avoid damage when stepped on. Warranties are invalidated when fitted with overhang in excess to that.

If not otherwise stated, Hardwood Threshold will be painted the same colour as Frame.



Contemporary Open In Flush French Door Triple Glazed - Coupling Thresh

DIMENSIONS	PLOT SIZE	SCALE	DATE	REV	DWG NO.
MM	A3	1:1	27.01.2011	A	0658

Please consider the environment before printing

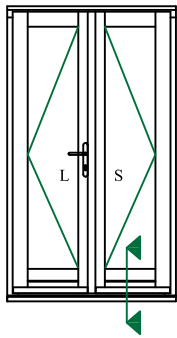
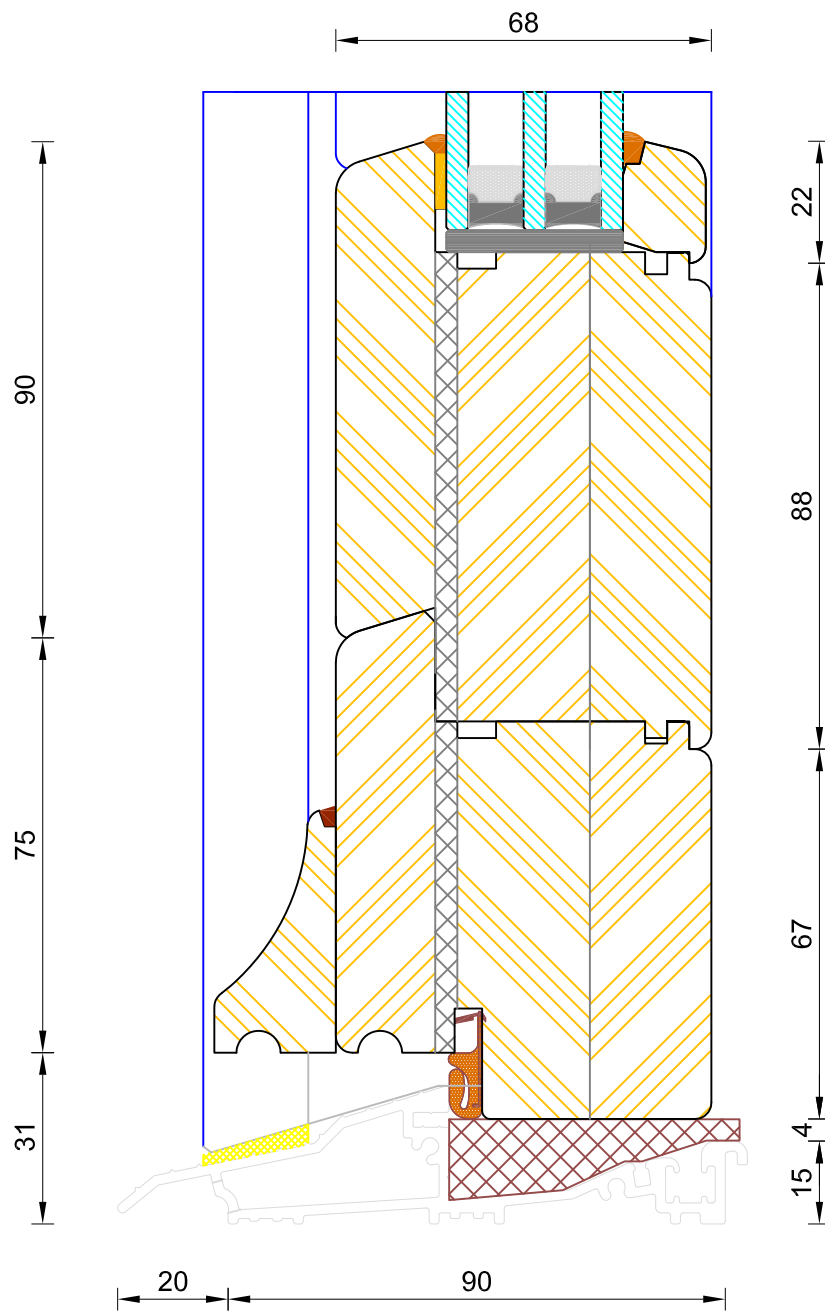

Contemporary Open In Flush French Door
Triple Glazed - Mobility Threshold

DIMENSIONS	PLOT SIZE	SCALE	DATE	REV	DWG NO.
MM	A3	1:1	27.01.2011	A	0659

Please consider the environment before printing

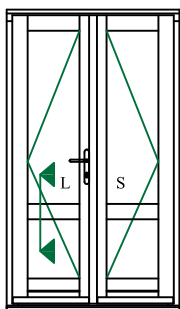
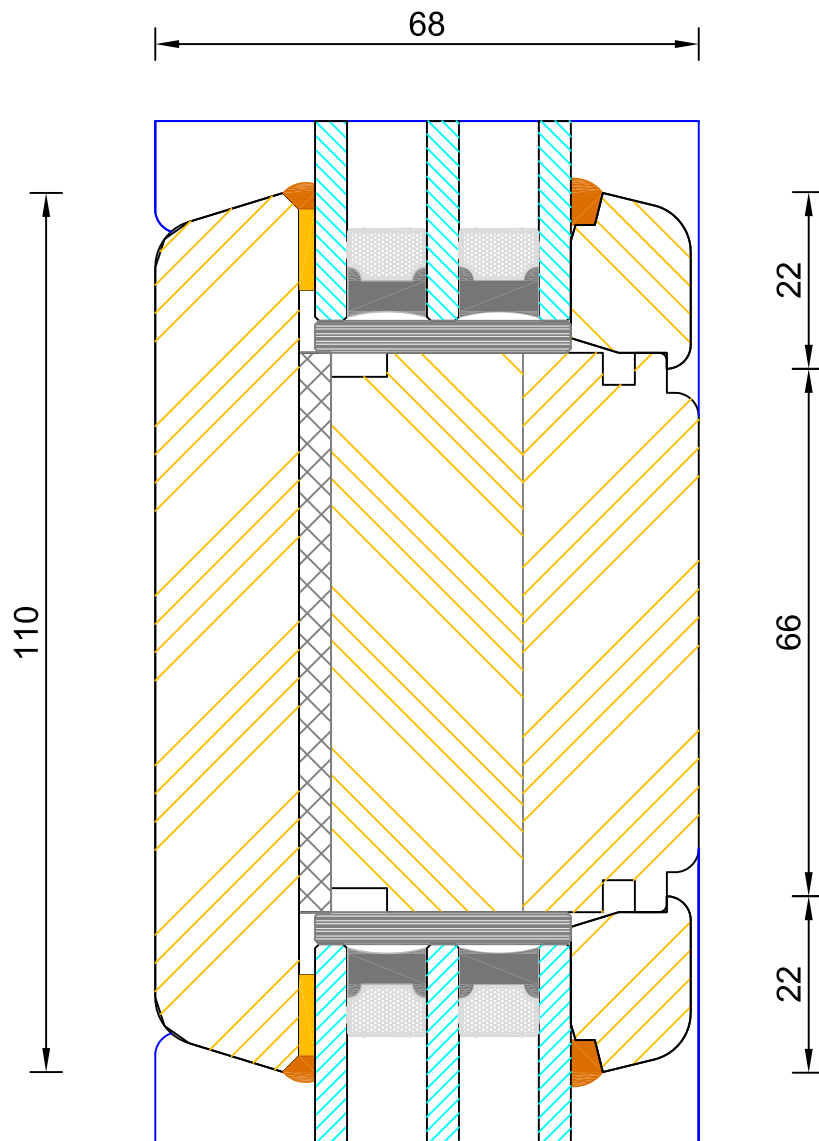

Contemporary Open In Flush Entrance Door
Triple Glazed - Mid Rail (110mm)

DIMENSIONS	PLOT SIZE	SCALE	DATE	REV	DWG NO.
MM	A4	1:1	27.01.2011	A	0660
 Please consider the environment before printing					