

Contemporary Open Out Flush Entrance Door
Triple Glazed - Cill Extension Options

DIMENSIONS	PLOT SIZE	SCALE	DATE	REV	DWG NO.
MM	A4	1:1	25.09.2019	B	1051
Please consider the environment before printing					

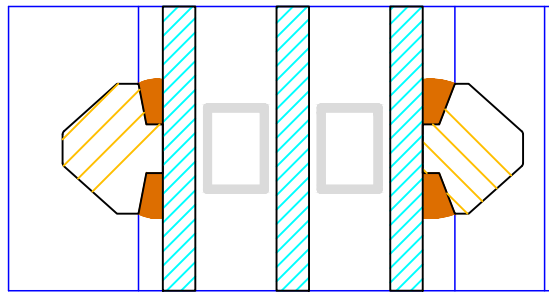

16

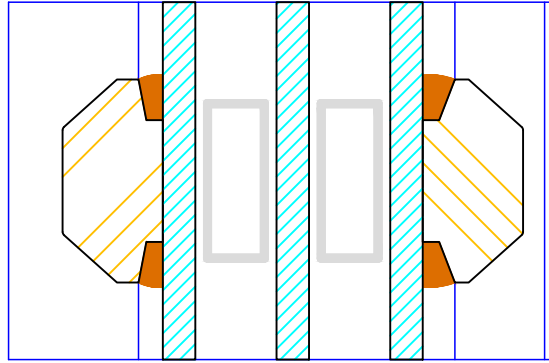

25

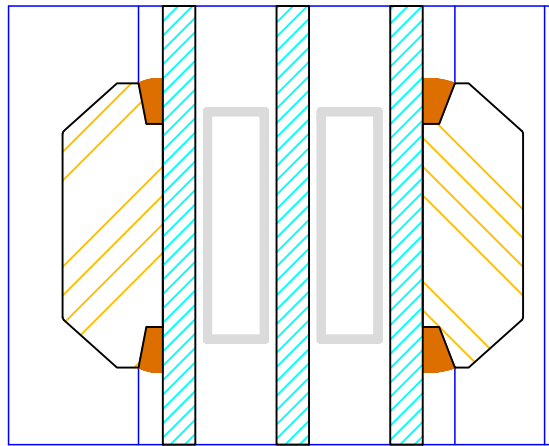

35

60 (varies min 60 / max 110mm)

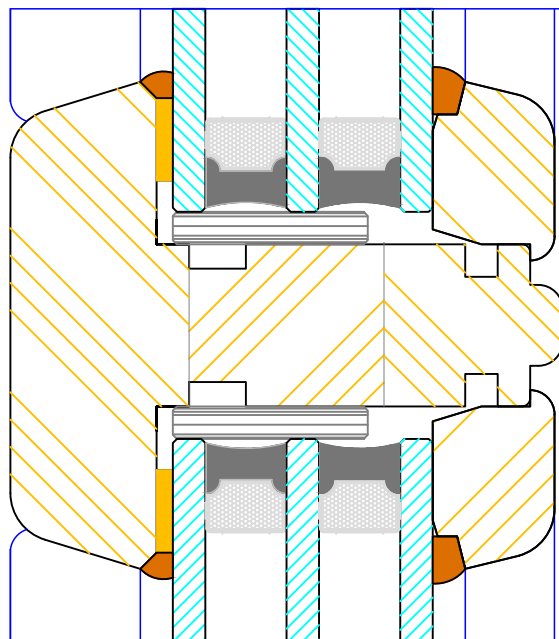

22
16
22

68

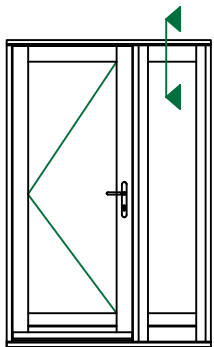
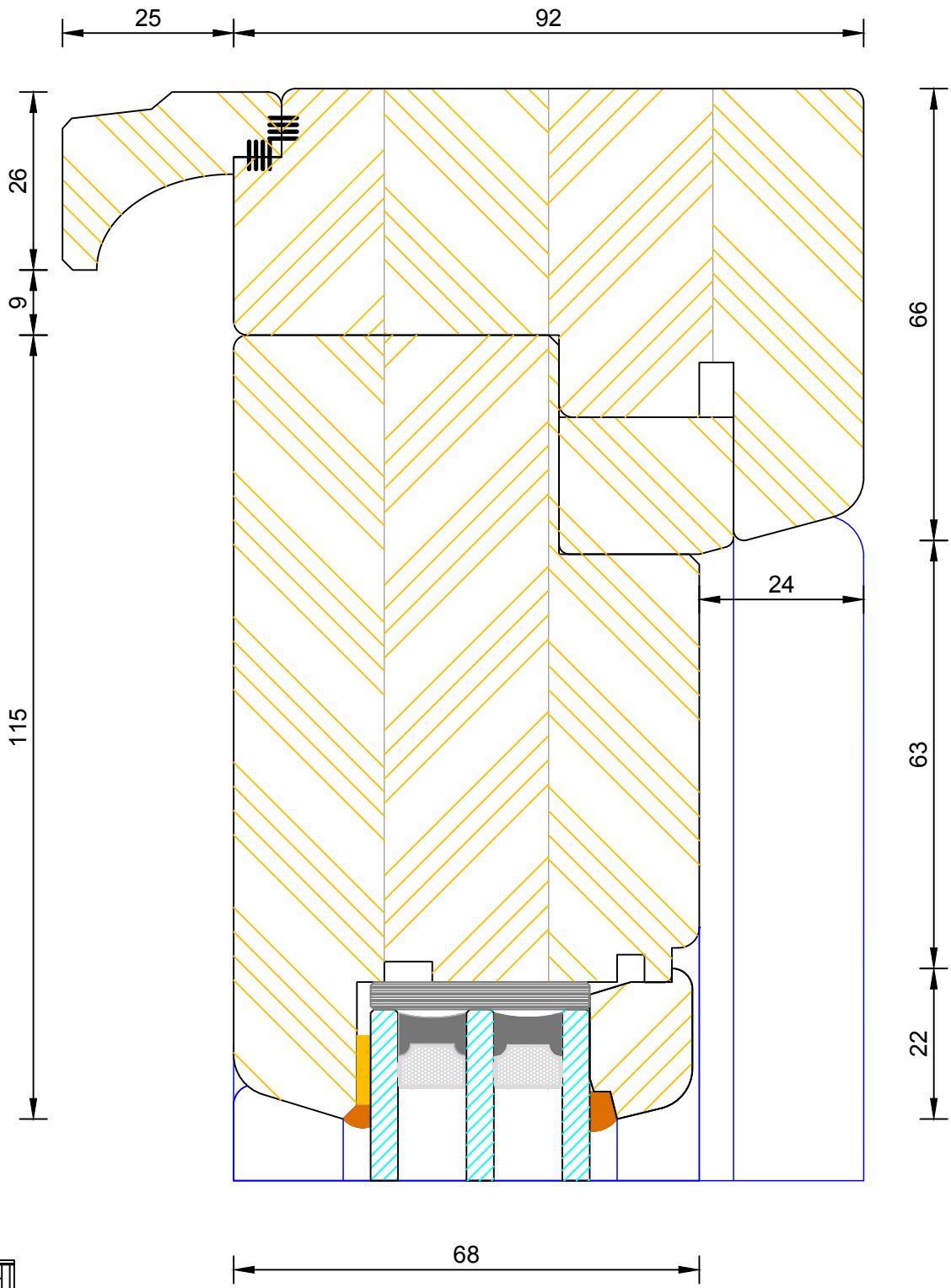

Contemporary Open Out Flush Entrance Door
Triple Glazed - Sidelight Head

DIMENSIONS	PLOT SIZE	SCALE	DATE	REV	DWG NO.
MM	A4	1:1	08.12.2010	A	1053

Please consider the environment before printing

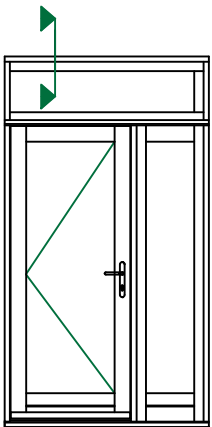
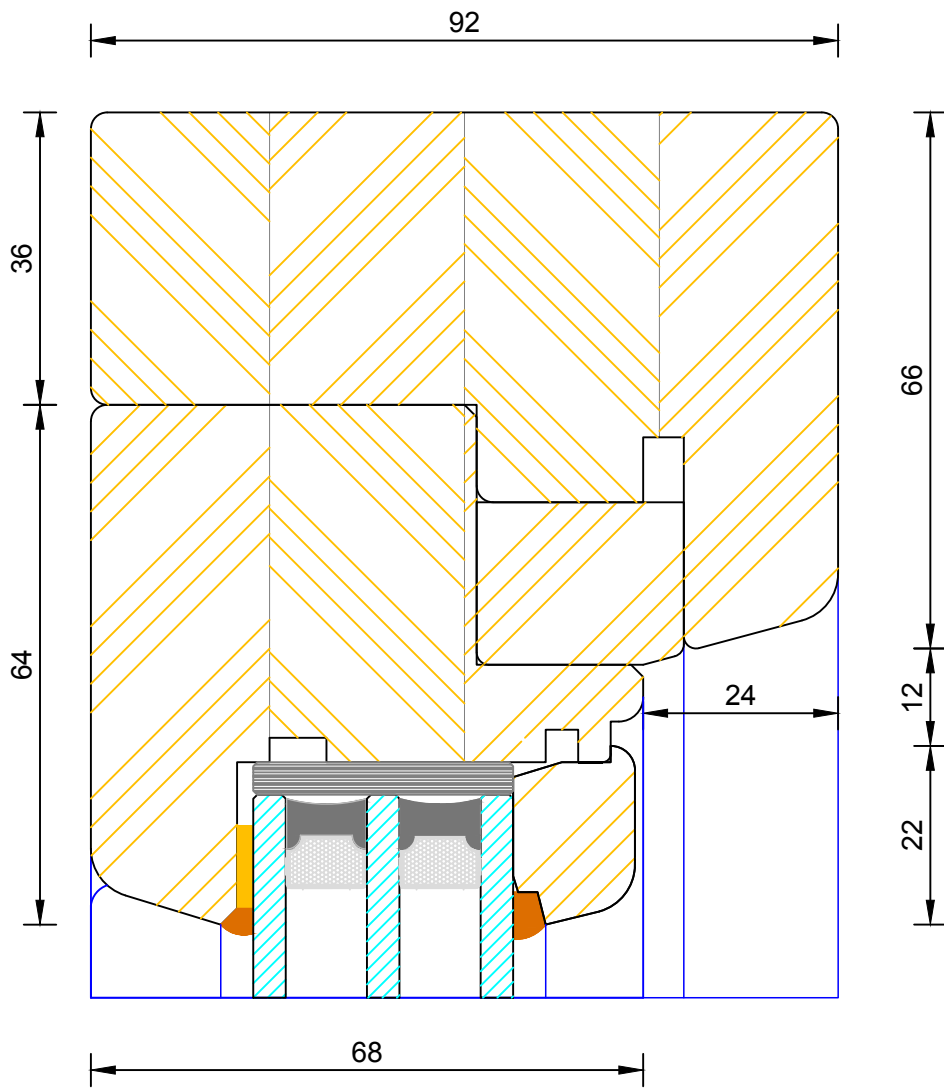

**Contemporary Open Out Flush Entrance Door
Triple Glazed - Fanlight Head**

DIMENSIONS	PLOT SIZE	SCALE	DATE	REV	DWG NO.
MM	A4	1:1	08.12.2010	A	1054

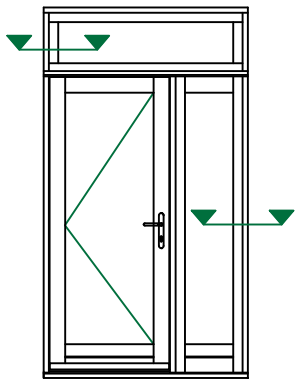
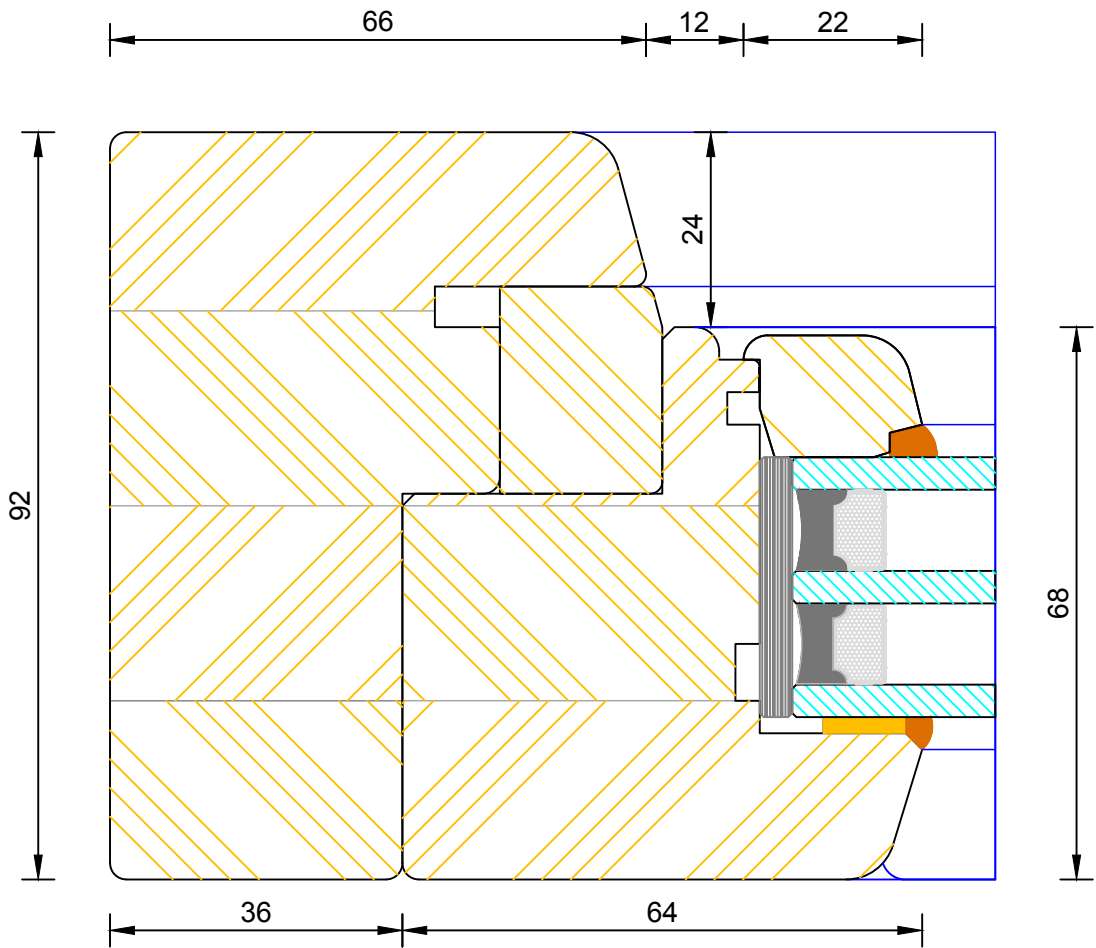

Contemporary Open Out Flush Entrance Door
Triple Glazed - Sidelight / Fanlight Jamb

DIMENSIONS	PLOT SIZE	SCALE	DATE	REV	DWG NO.
MM	A4	1:1	08.12.2010	A	1055

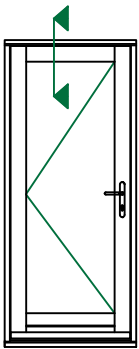
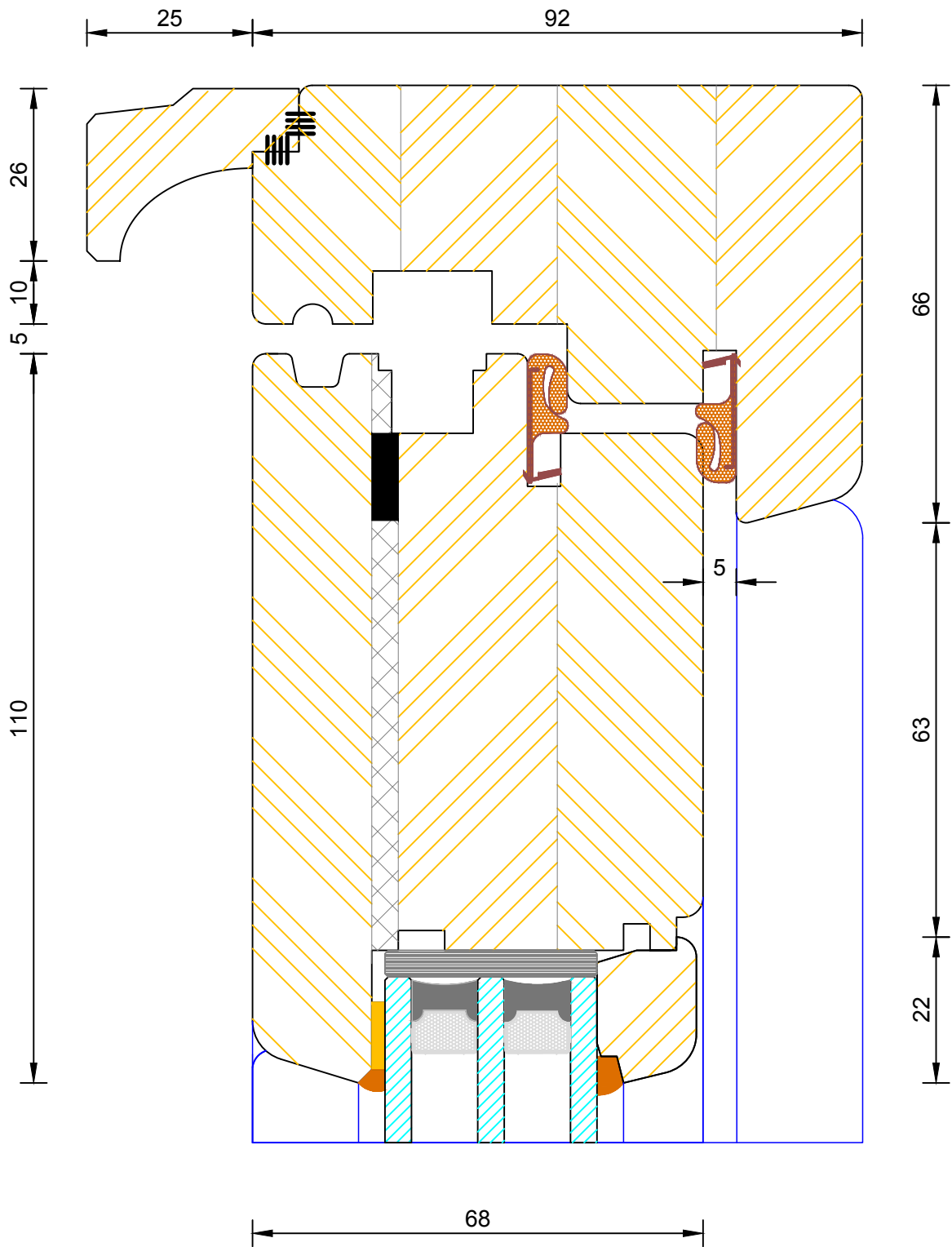

Contemporary Open Out Flush Entrance Door Triple Glazed - Frame & Leaf Head

DIMENSIONS	PLOT SIZE	SCALE	DATE	REV	DWG NO.
MM	A4	1:1	08.12.2010	A	1059

Please consider the environment before printing

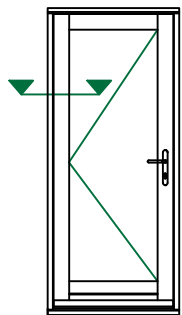
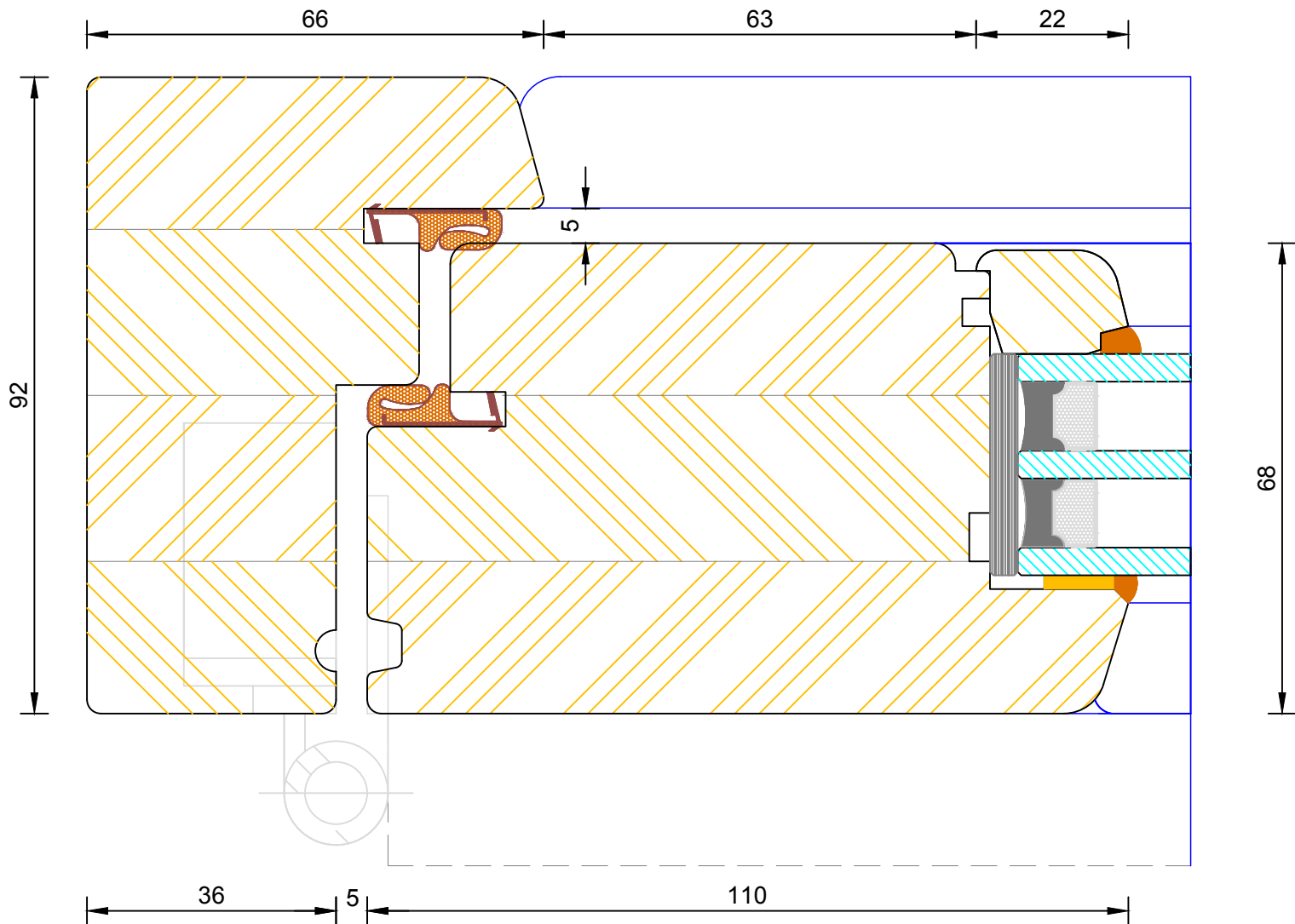

Note: Hinge colour available in Stainless Steel only.



Contemporary Open Out Flush Entrance Door Triple Glazed - Frame & Leaf Jamb (Hinge Side)

DIMENSIONS	PLOT SIZE	SCALE	DATE	REV	DWG NO.
MM	A4	1:1	08.12.2010	A	1060

Please consider the environment before printing

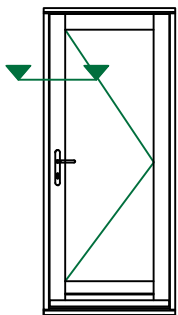
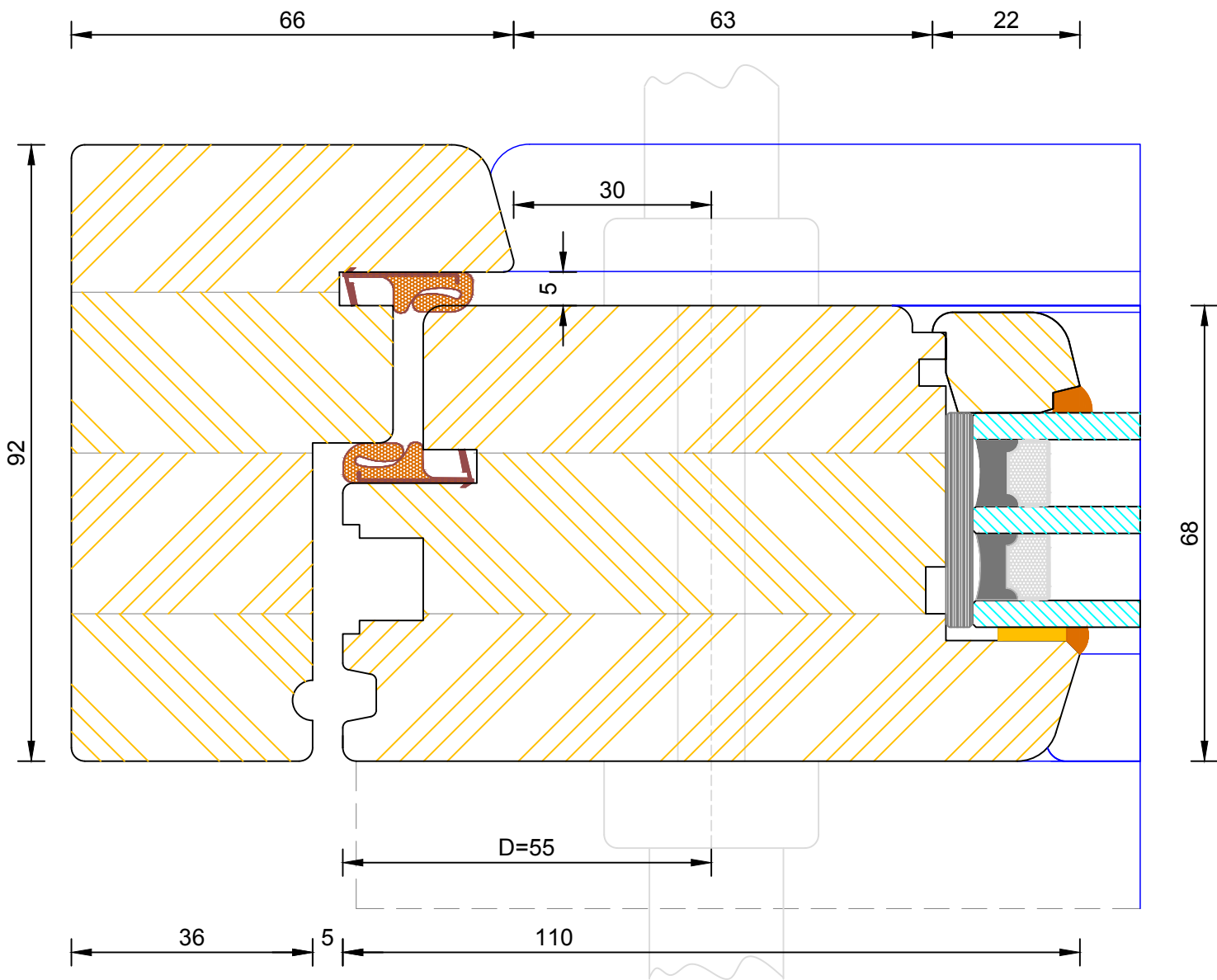

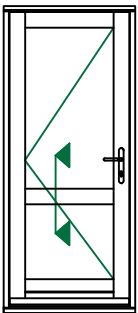
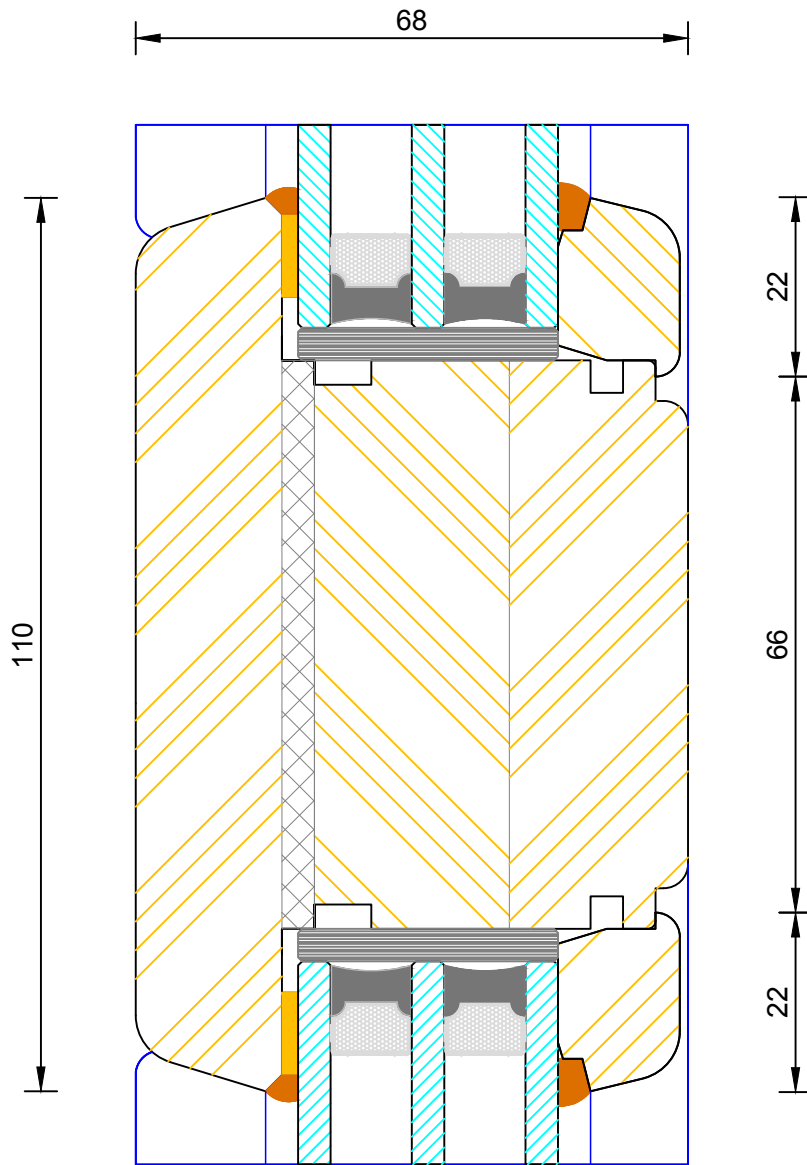

68 24

54 26 9 115

25

22 12 85 63 22

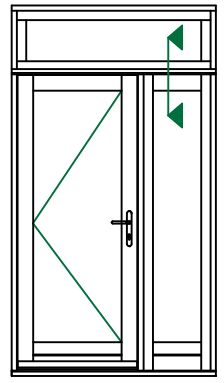
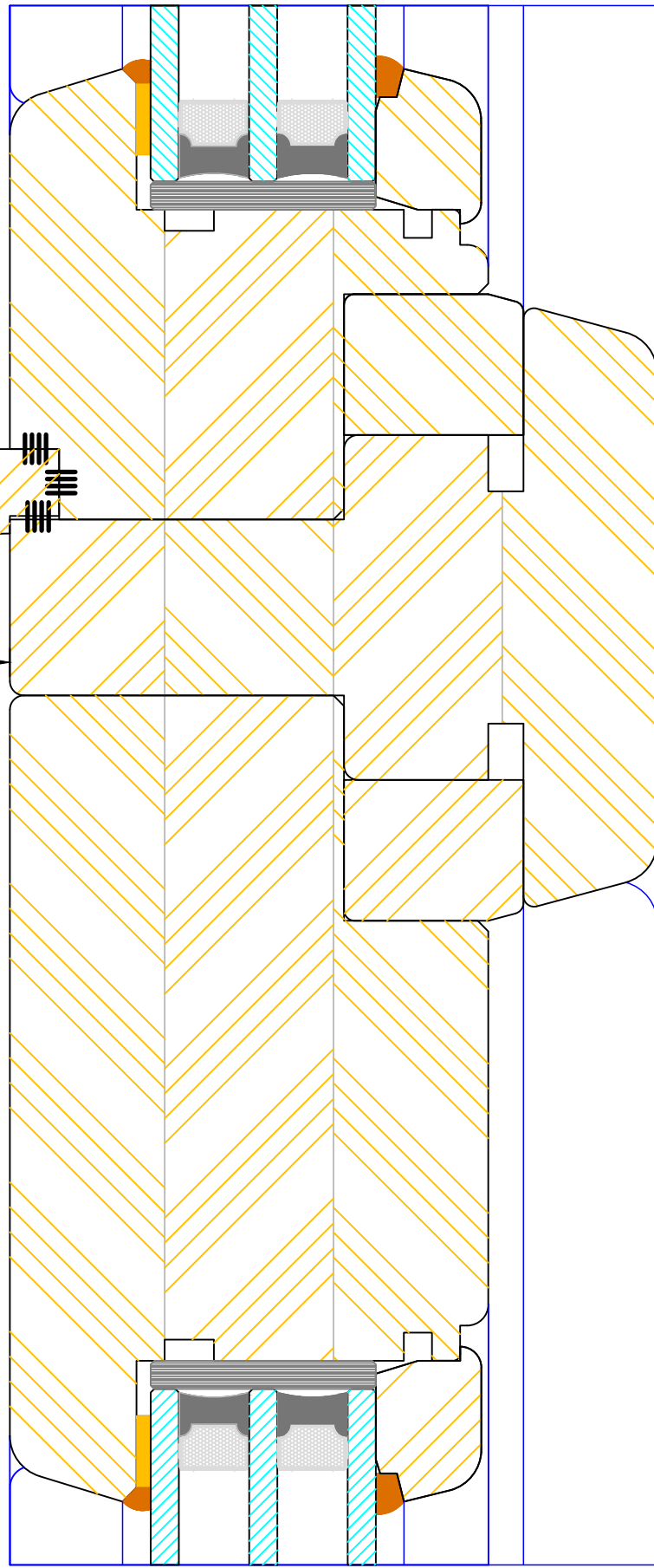

Contemporary Open Out Flush Entrance Door
 Triple Glazed - Solid Transom (Fanlight / Sidelight)

DIMENSIONS	PLOT SIZE	SCALE	DATE	REV	DWG NO.
MM	A4	1:1	08.12.2010	A	1066

Please consider the environment before printing

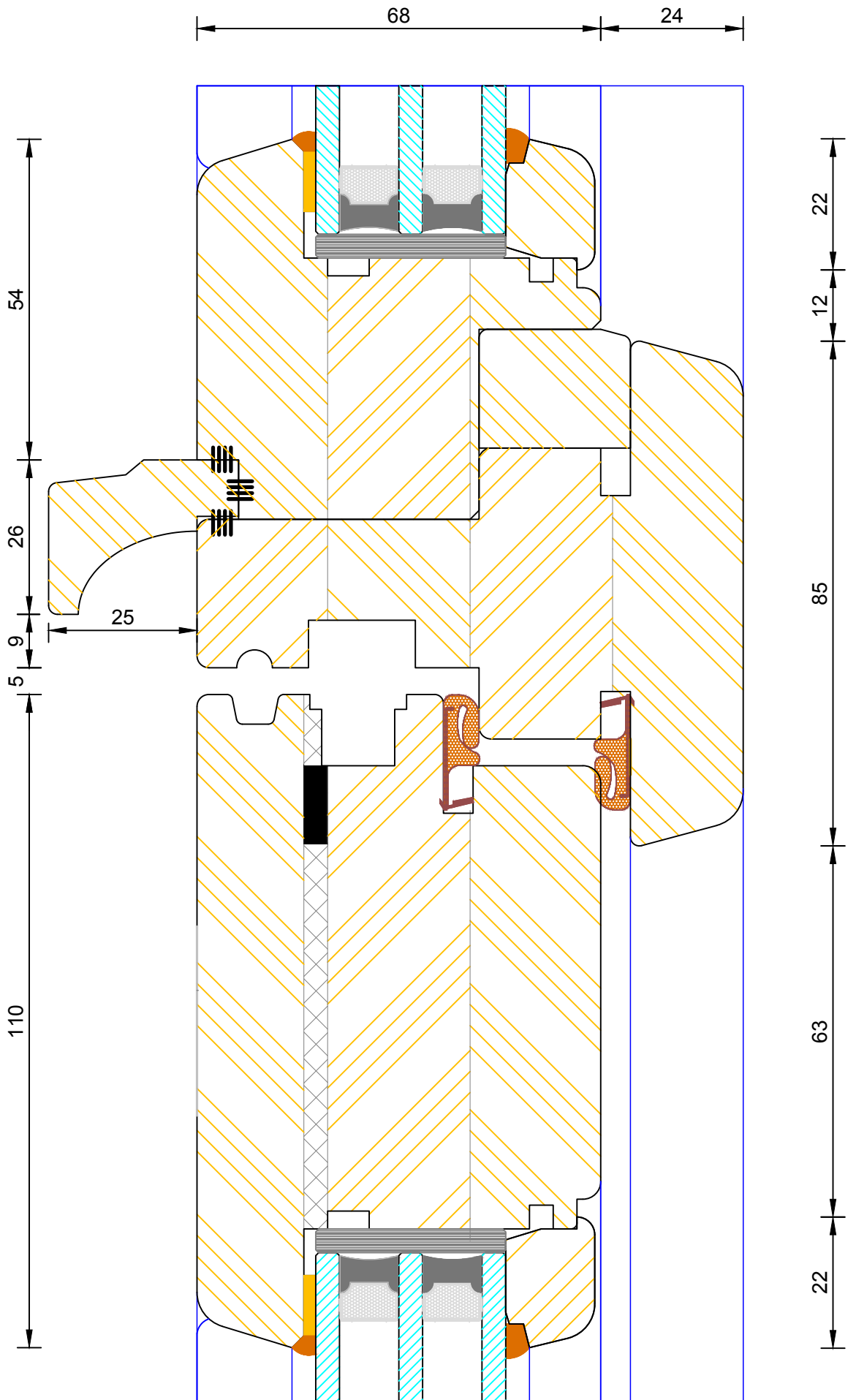
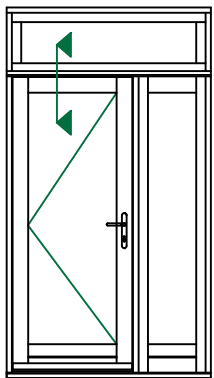

Contemporary Open Out Flush Entrance Door
Triple Glazed - Solid Transom (Fanlight / Door Leaf)

DIMENSIONS	PLOT SIZE	SCALE	DATE	REV	DWG NO.
MM	A4	1:1	08.12.2010	A	1067

Please consider the environment before printing

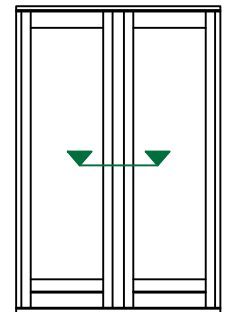
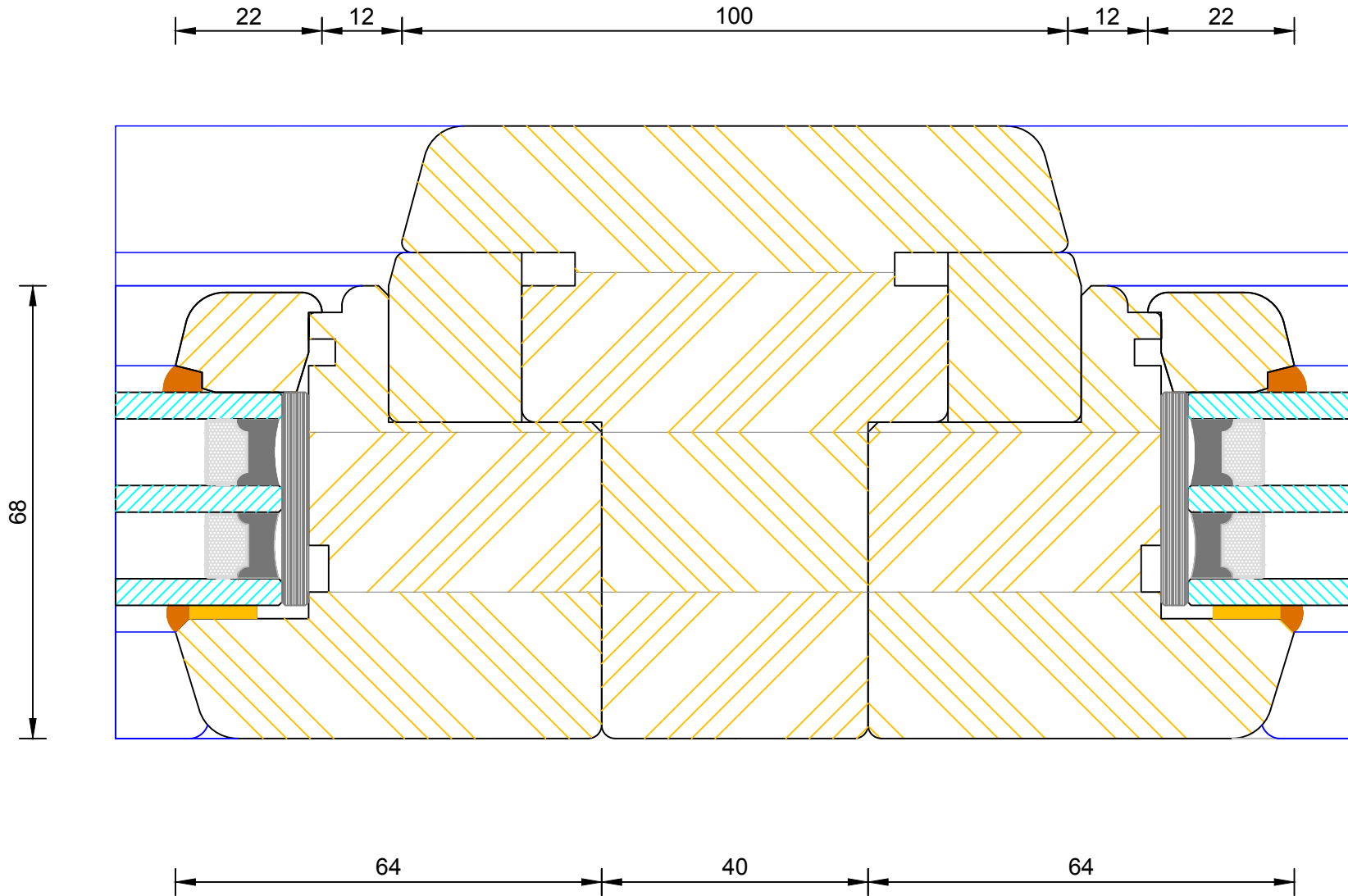

Contemporary Open Out Flush Entrance Door
 Triple Glazed - Solid Mullion (Fixed Light / Fixed Light)

DIMENSIONS	PLOT SIZE	SCALE	DATE	REV	DWG NO.
MM	A4	1:1	07.02.2011	A	1068

Please consider the environment before printing

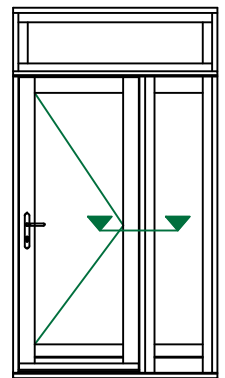
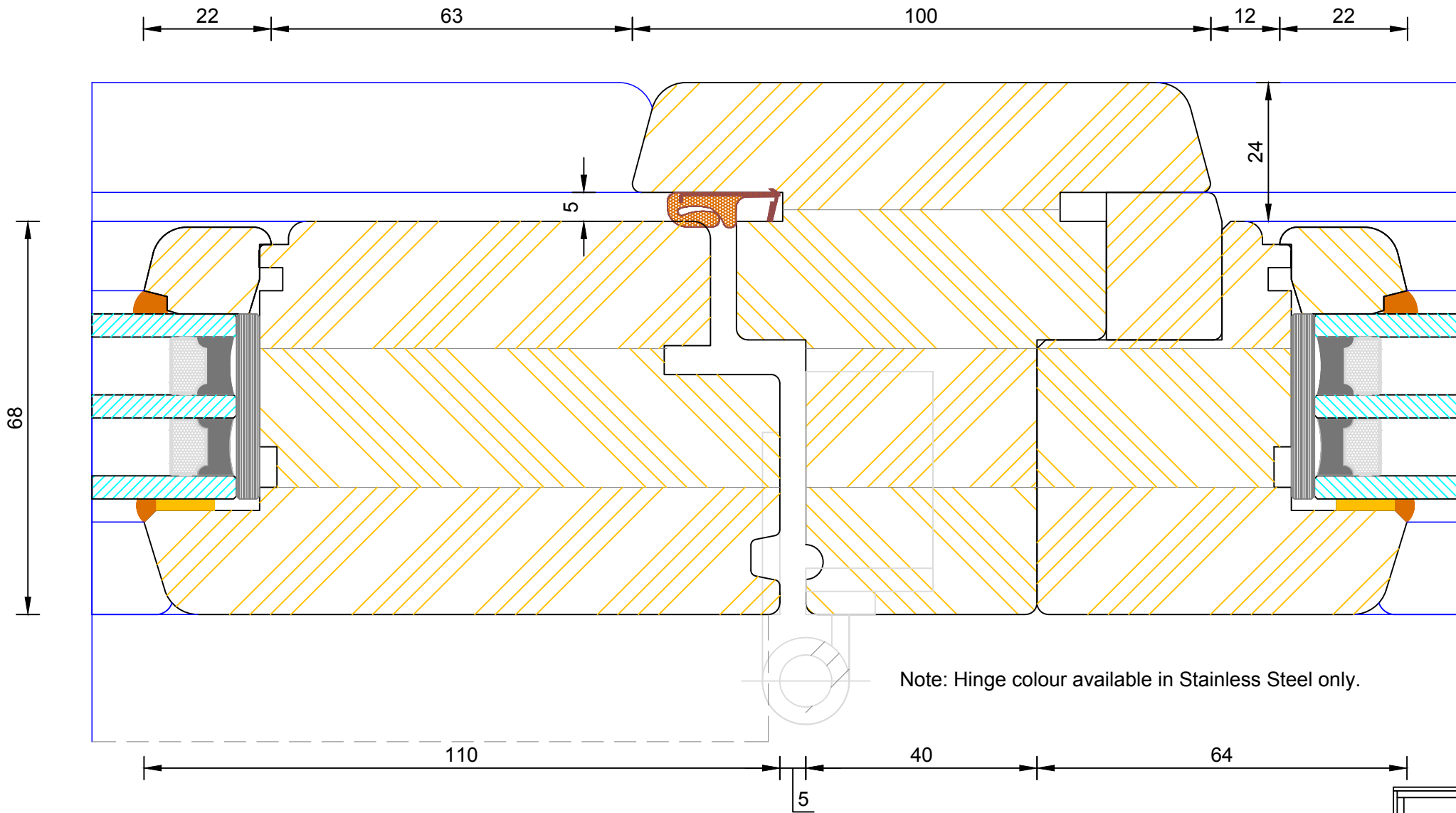

Contemporary Open Out Flush Entrance Door
 Triple Glazed - Solid Mullion (Leaf / Side Light)

DIMENSIONS	PLOT SIZE	SCALE	DATE	REV	DWG NO.
MM	A4	1:1	07.02.2011	A	1069
Please consider the environment before printing					

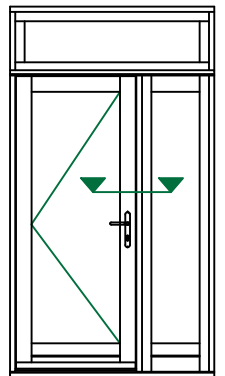
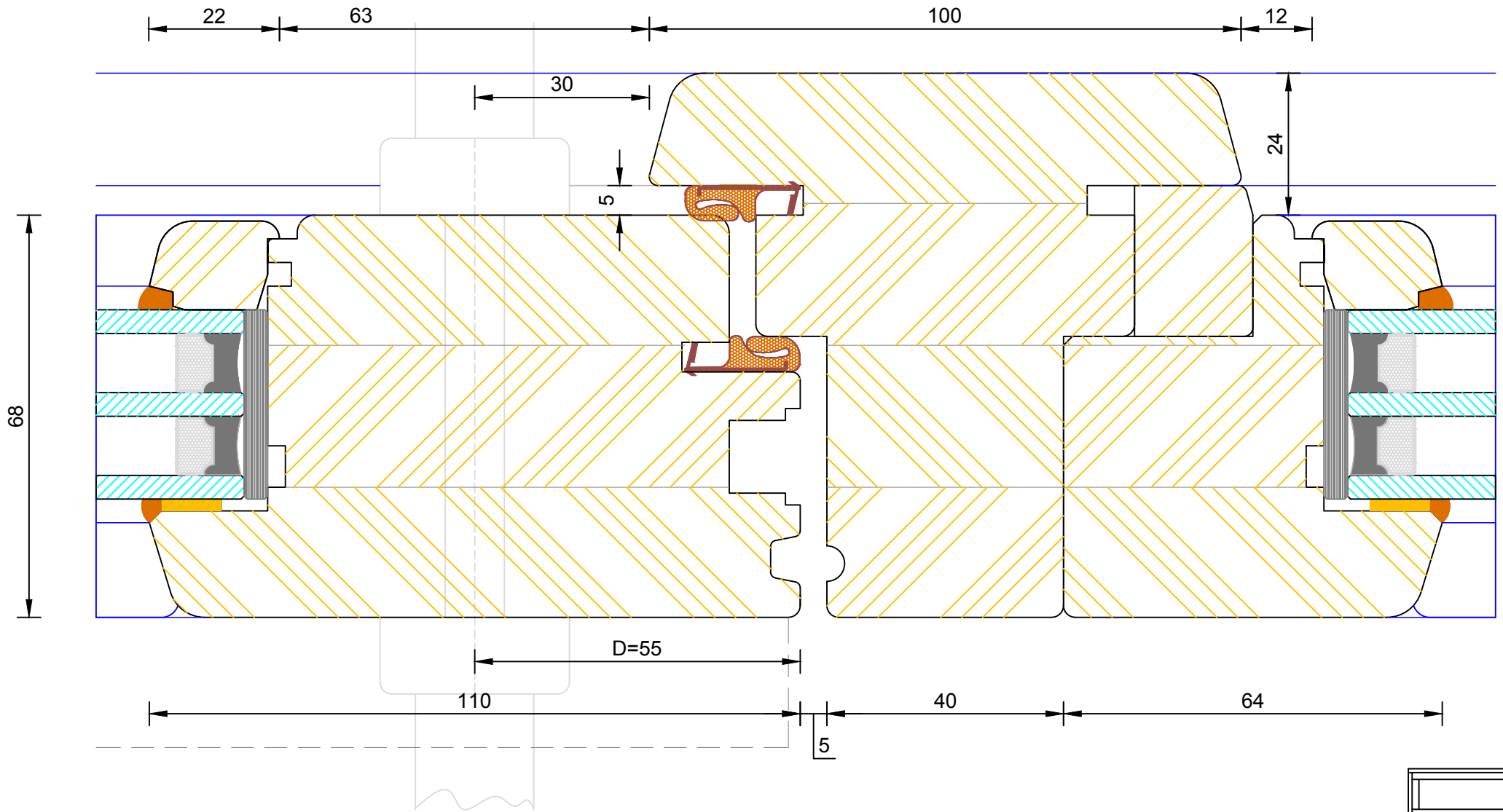

Contemporary Open Out Flush Entrance Door
Triple Glazed - Solid Mullion (Leaf / Side Light)

DIMENSIONS	PLOT SIZE	SCALE	DATE	REV	DWG NO.
MM	A4	1:1	07.02.2011	A	1070
Please consider the environment before printing					

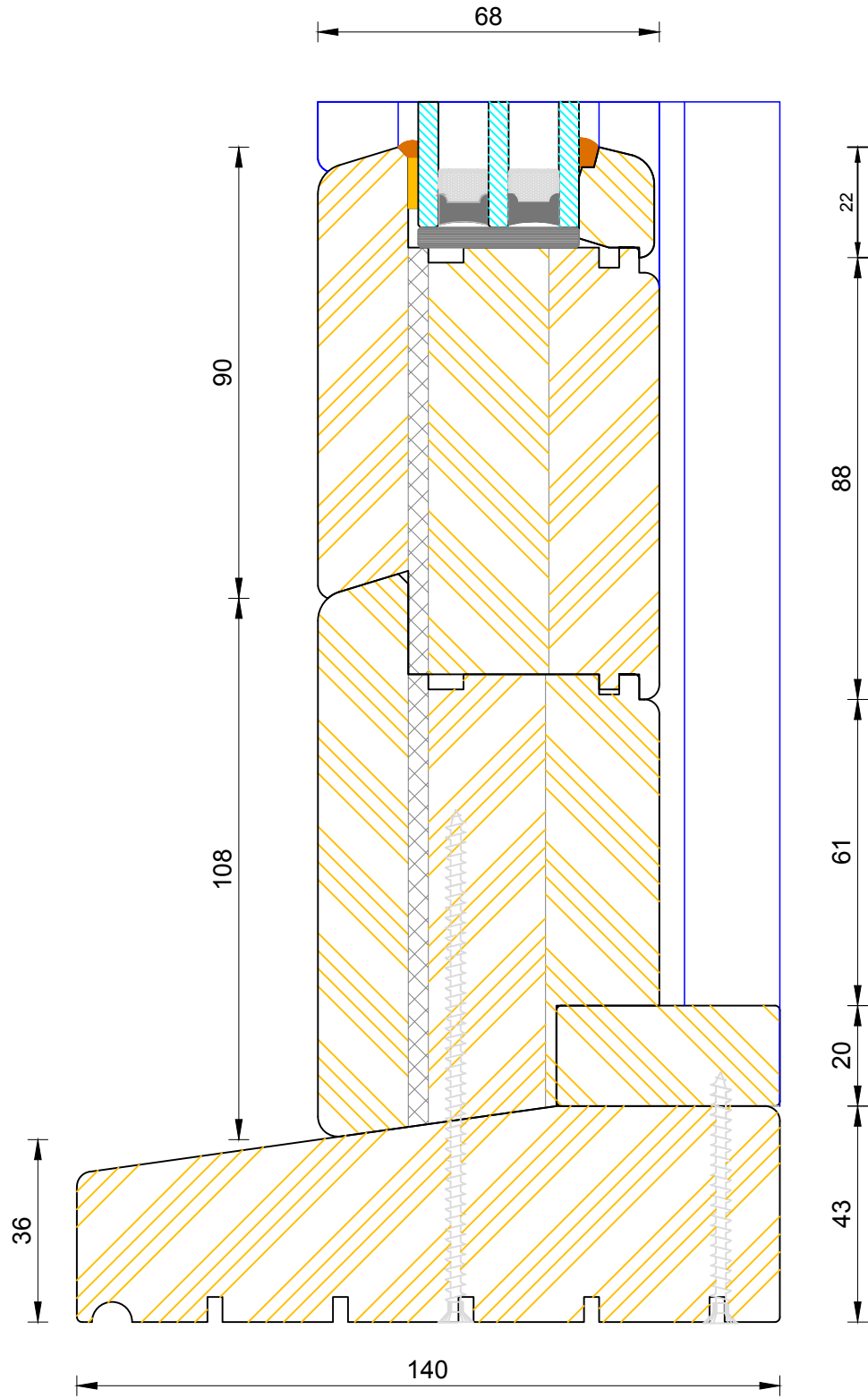
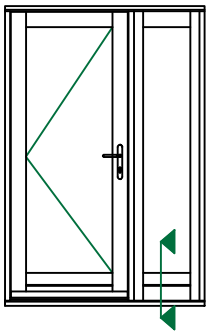

Contemporary Open Out Flush Entrance Door
 Triple Glazed - Standard Thresh (Sidelight)

DIMENSIONS	PLOT SIZE	SCALE	DATE	REV	DWG NO.
MM	A3	1:1	08.12.2010	A	1056

Please consider the environment before printing

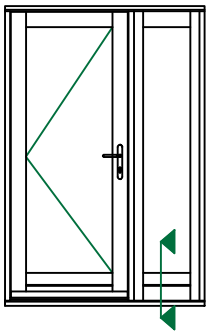
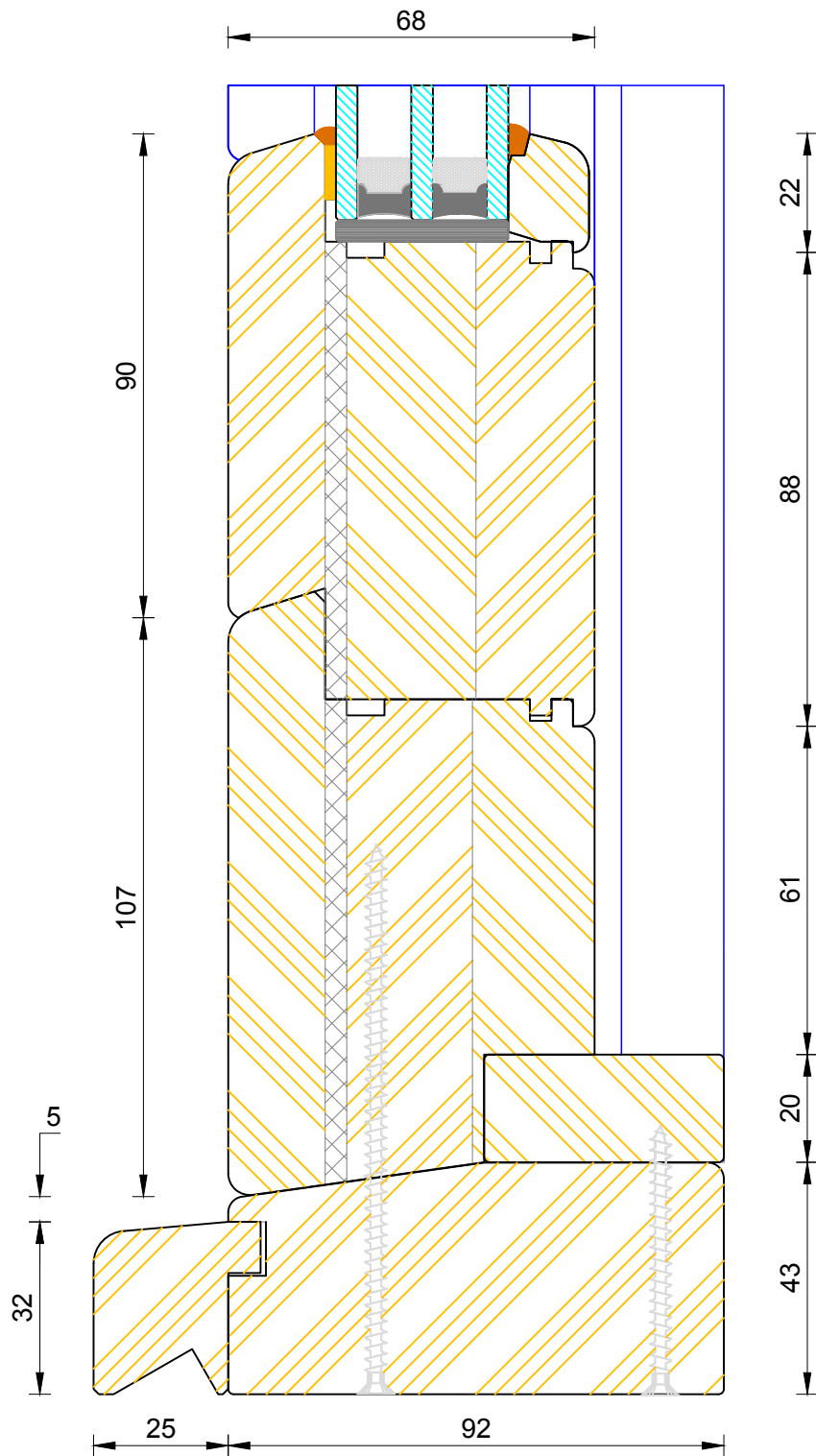

CILL EXTENSION - available options: 25mm (117mm o/a) / 47mm (139mm o/a) / 62mm (154mm o/a) / 87mm (179mm o/a) / 114mm (206mm o/a) / 125mm (217mm o/a) / 140mm (232mm o/a)

NOTE: Cill Extensions should be supported from underneath; the maximum overhang over Brick / Blockwork for cill extension should not exceed 25mm in order to avoid damage when stepped on. Warranties are invalidated when fitted with overhang in excess to that.

If not otherwise stated, Hardwood Threshold will be painted the same colour as Frame.



Contemporary Open Out Flush Entrance Door Triple Glazed - Coupling Thresh (Sidelight)

DIMENSIONS	PLOT SIZE	SCALE	DATE	REV	DWG NO.
MM	A3	1:1	08.12.2010	A	1057

Please consider the environment before printing

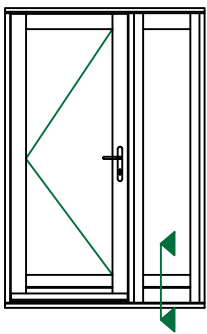
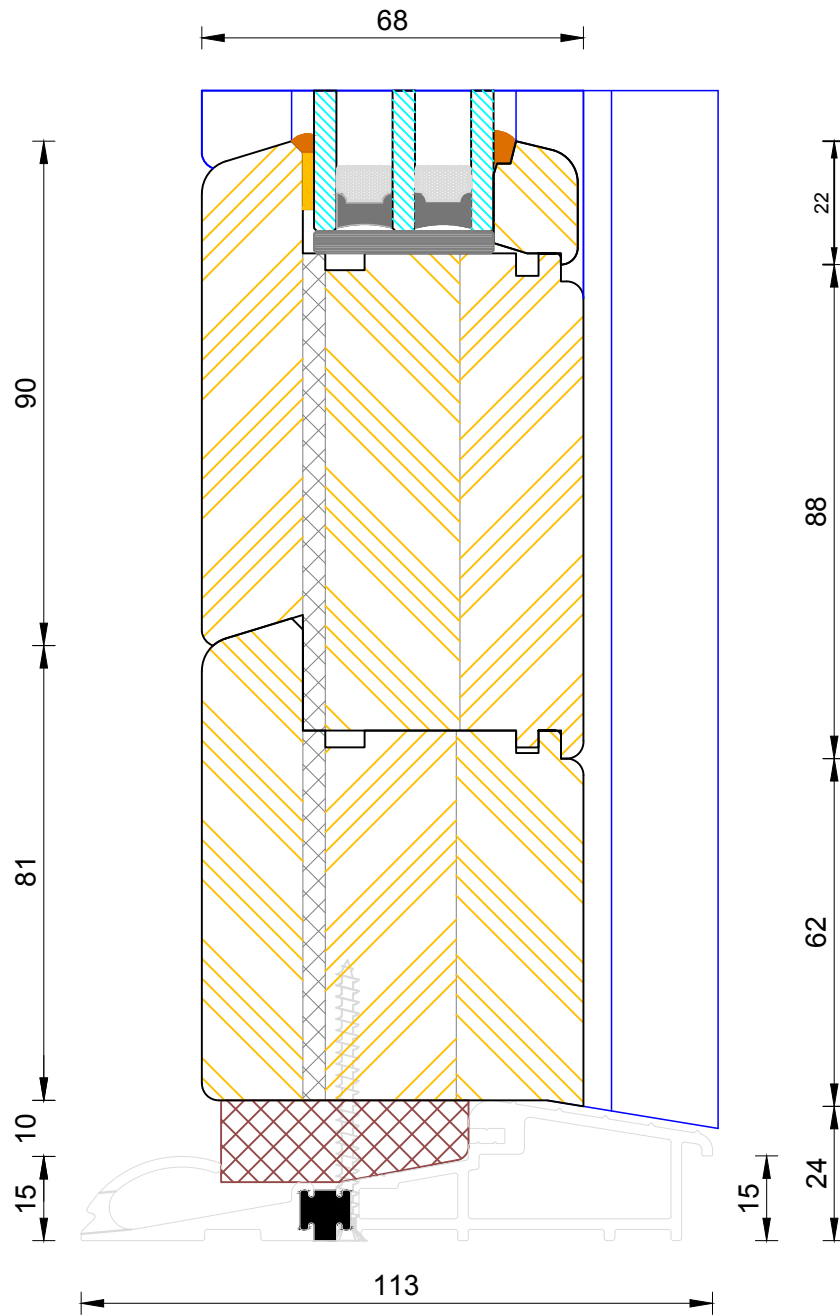

**Contemporary Open Out Flush Entrance Door
Triple Glazed - Mobility Thresh (Sidelight)**

DIMENSIONS	PLOT SIZE	SCALE	DATE	REV	DWG NO.
MM	A3	1:1	08.12.2010	A	1058

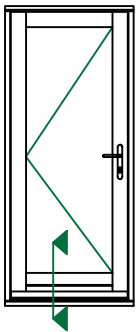
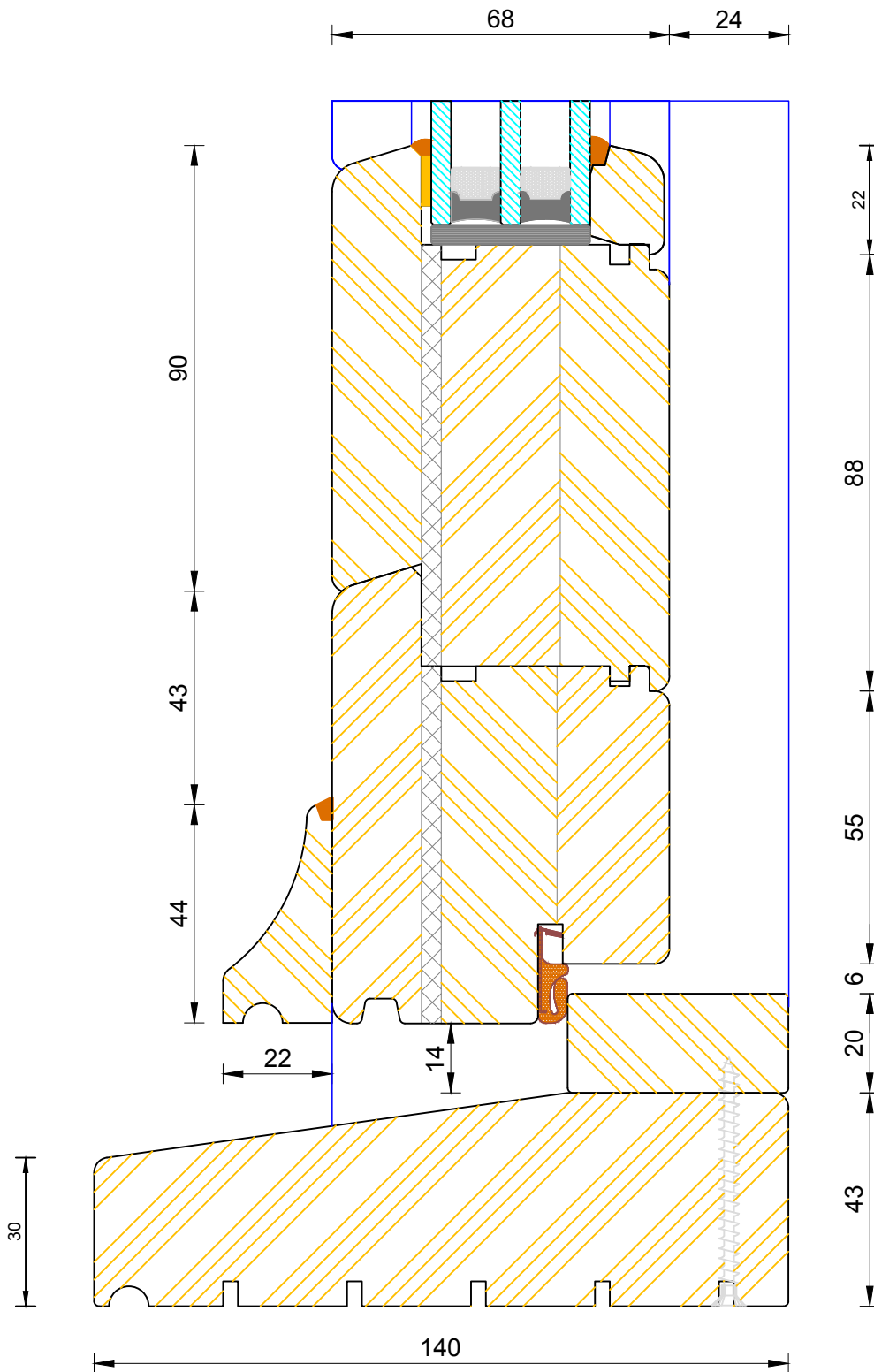

Contemporary Open Out Flush Entrance Door
 Triple Glazed - Standard Thresh (140x43mm)

DIMENSIONS	PLOT SIZE	SCALE	DATE	REV	DWG NO.
MM	A3	1:1	08.12.2010	A	1062

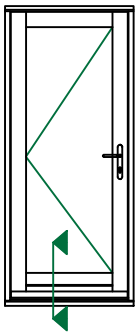
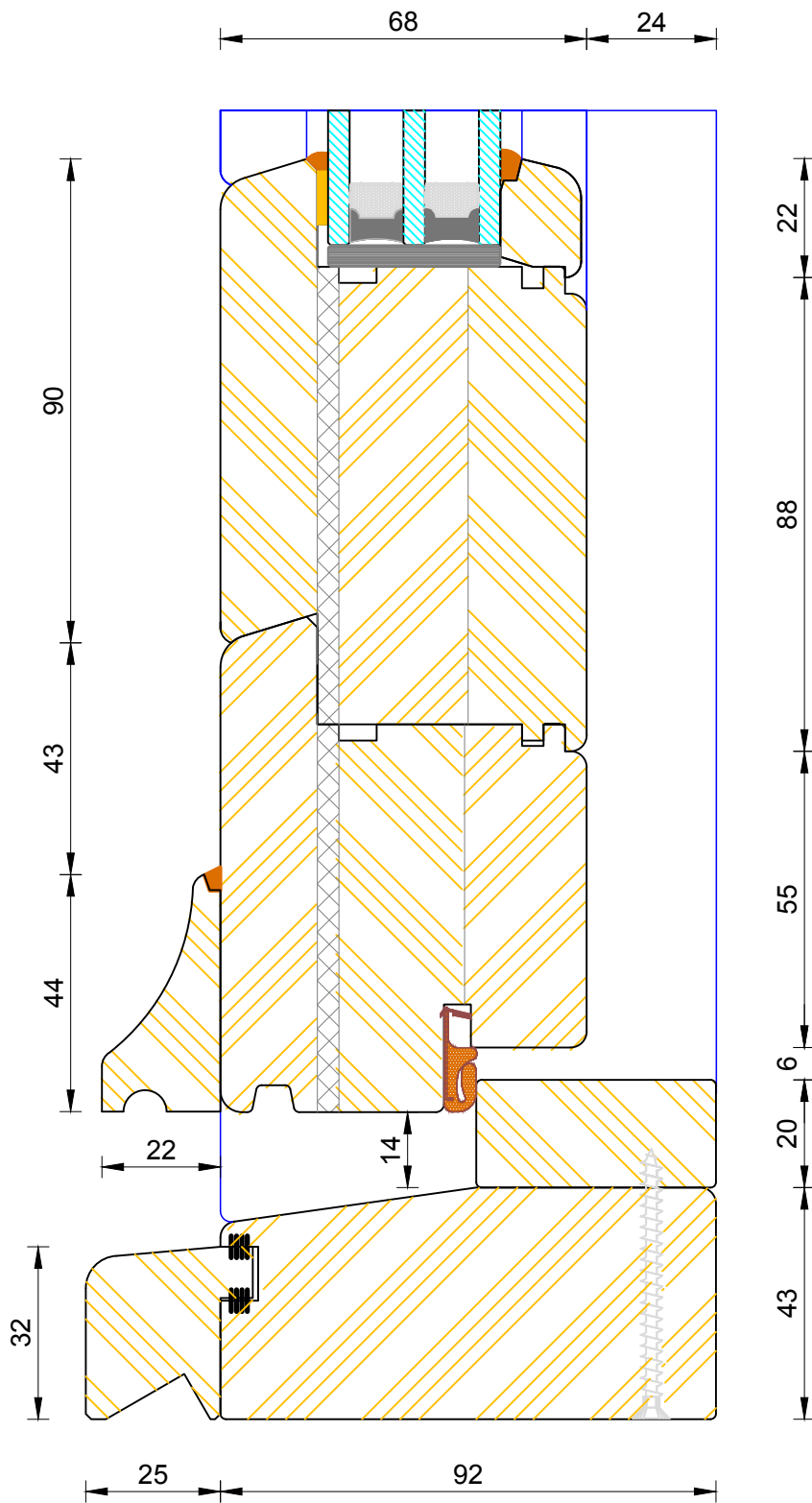

CILL EXTENSION - available options: 25mm (117mm o/a) / 47mm (139mm o/a) / 62mm (154mm o/a) / 87mm (179mm o/a) / 114mm (206mm o/a) / 125mm (217mm o/a) / 140mm (232mm o/a)

NOTE: Cill Extensions should be supported from underneath; the maximum overhang over Brick / Blockwork for cill extension should not exceed 25mm in order to avoid damage when stepped on. Warranties are invalidated when fitted with overhang in excess to that.

If not otherwise stated, Hardwood Threshold will be painted the same colour as Frame.

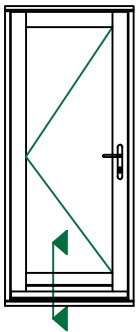
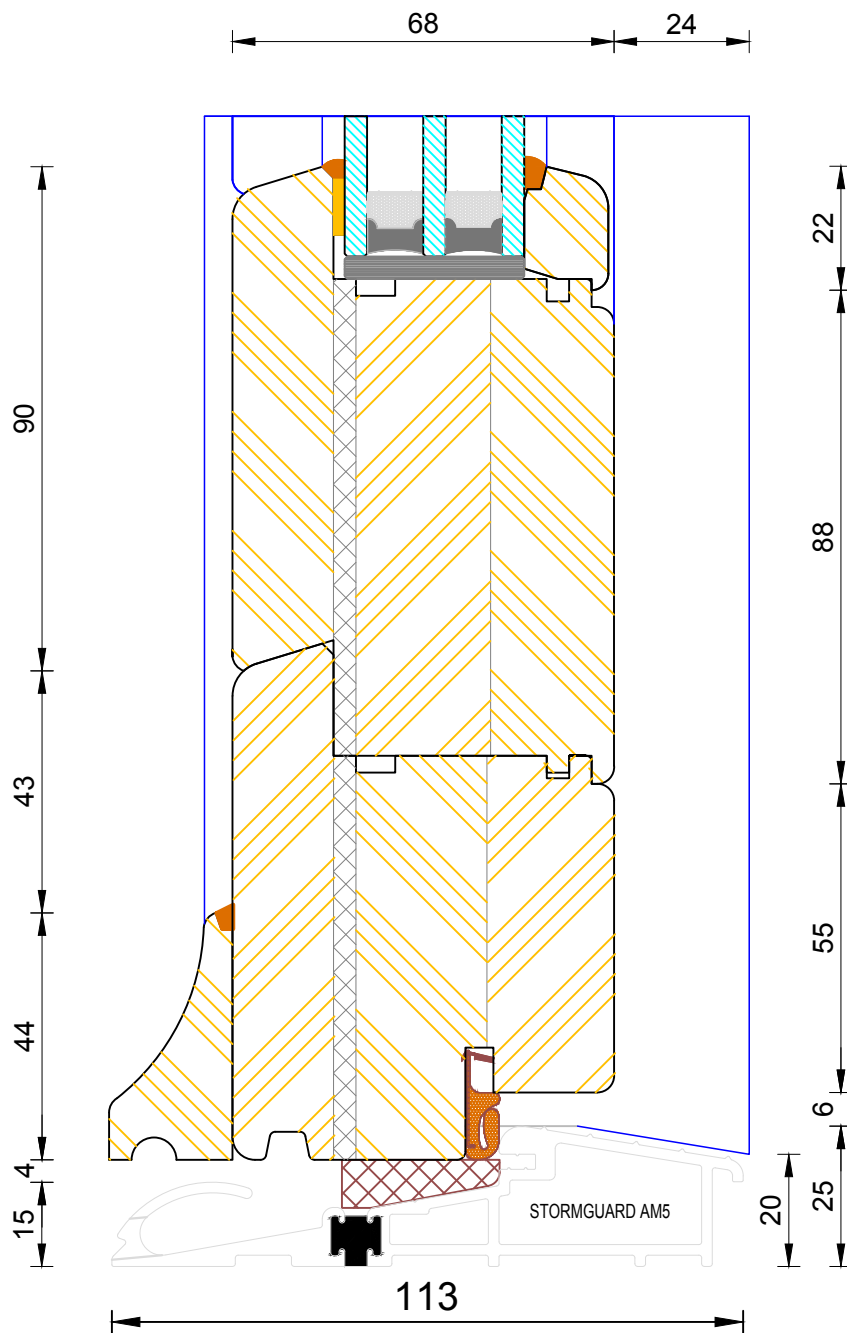

Bereco

**Contemporary Open Out Flush Entrance Door
Triple Glazed - Mobility Thresh**

DIMENSIONS	PLOT SIZE	SCALE	DATE	REV	DWG NO.
MM	A3	1:1	08.12.2010	A	1064

Please consider the environment before printing