

Contemporary Open In Flush Entrance Door
Triple Glazed - Cill Extension Options

DIMENSIONS	PLOT SIZE	SCALE	DATE	REV	DWG NO.
MM	A4	1:1	25.09.2019	B	1151
Please consider the environment before printing					

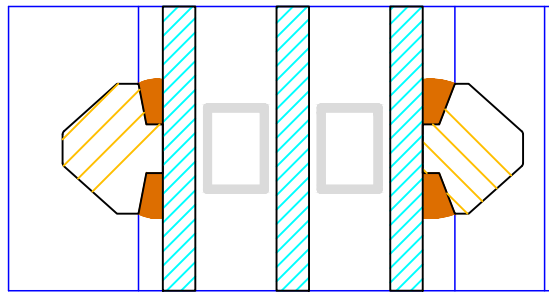

16

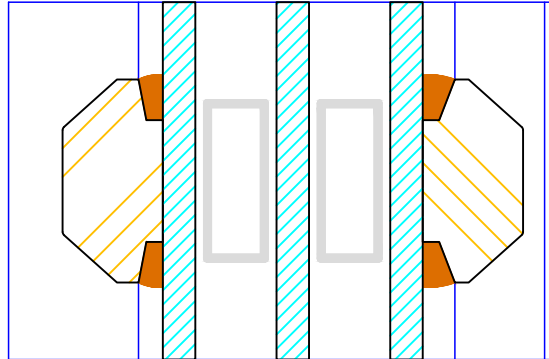

25

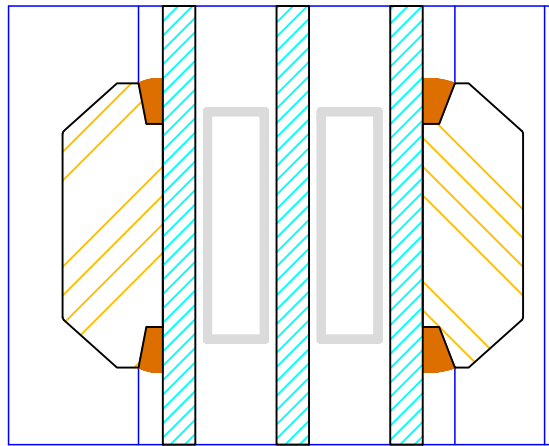

35

60 (varies min 60 / max 110mm)

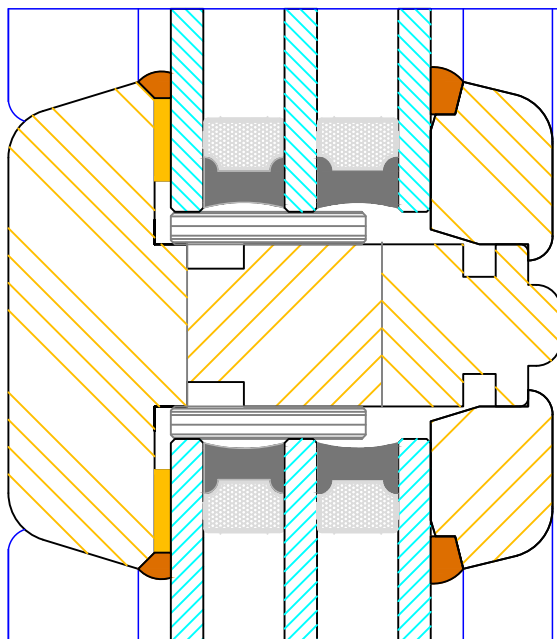

22
16
22

68



Bereco

**Contemporary Open In Flush Entrance Door
Triple Glazed - Bar Options**

DIMENSIONS	PLOT SIZE	SCALE	DATE	REV	DWG NO.
MM	A4	1:1	27.01.2011	A	1152

Please consider the environment before printing

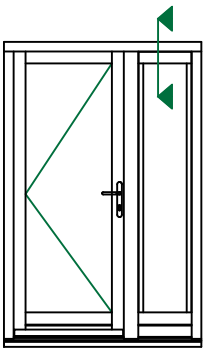
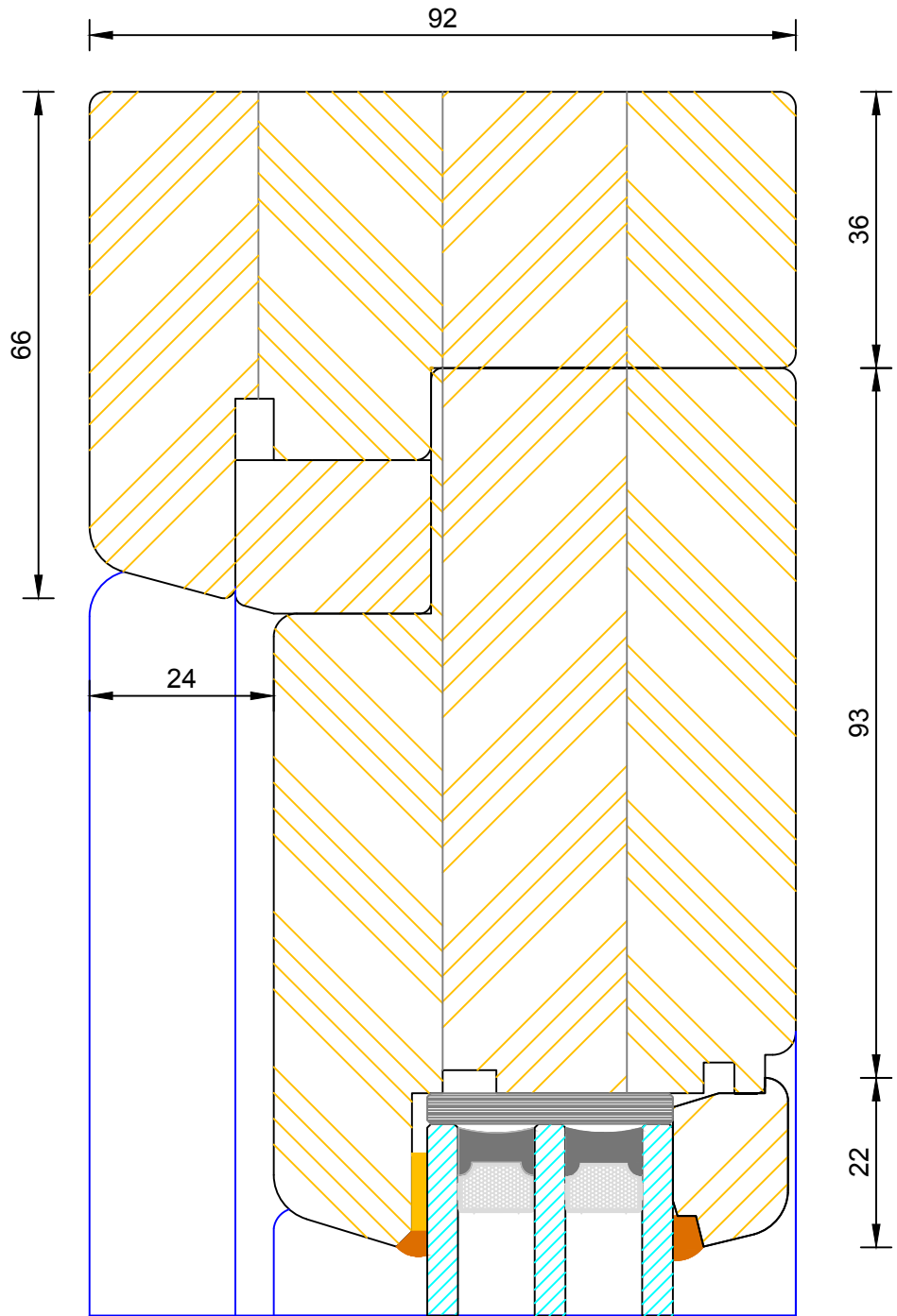

DIMENSIONS	PLOT SIZE	SCALE	DATE	REV	DWG NO.
MM	A4	1:1	27.01.2011	A	1153
Please consider the environment before printing					

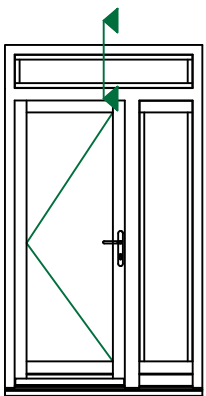
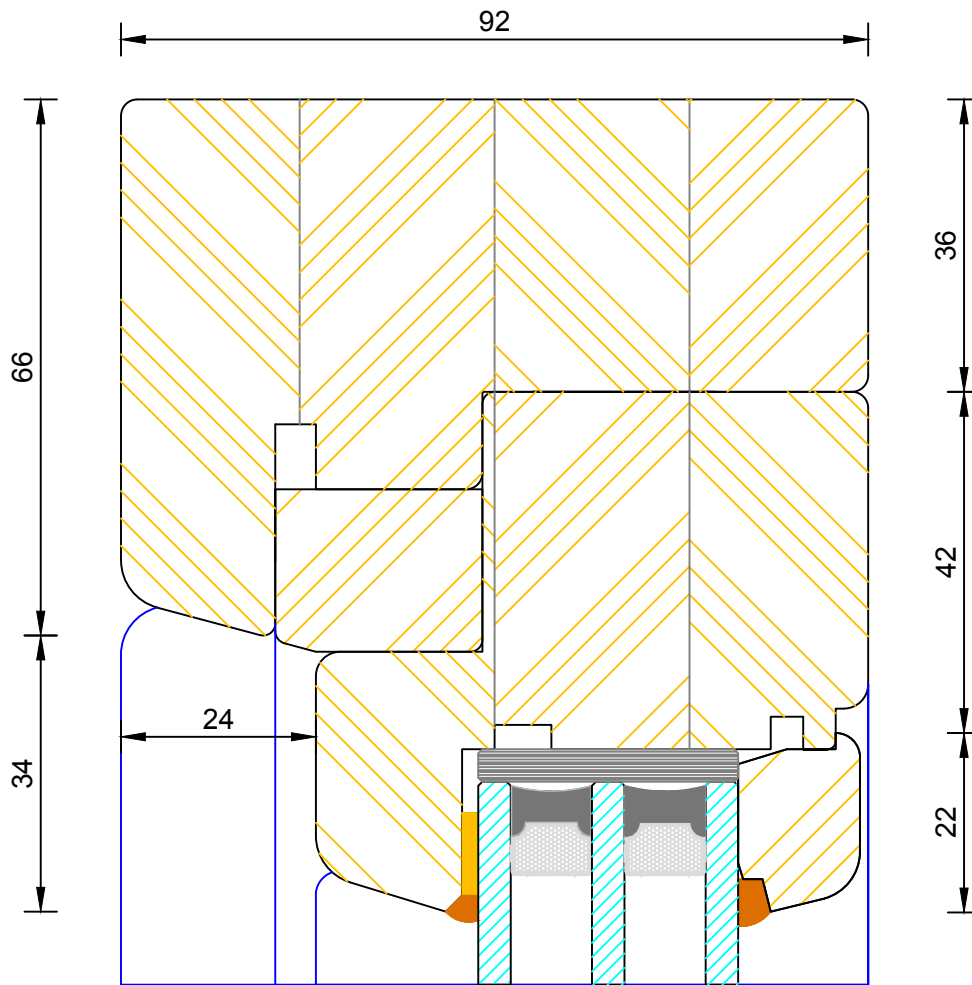

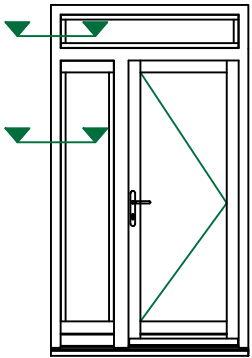
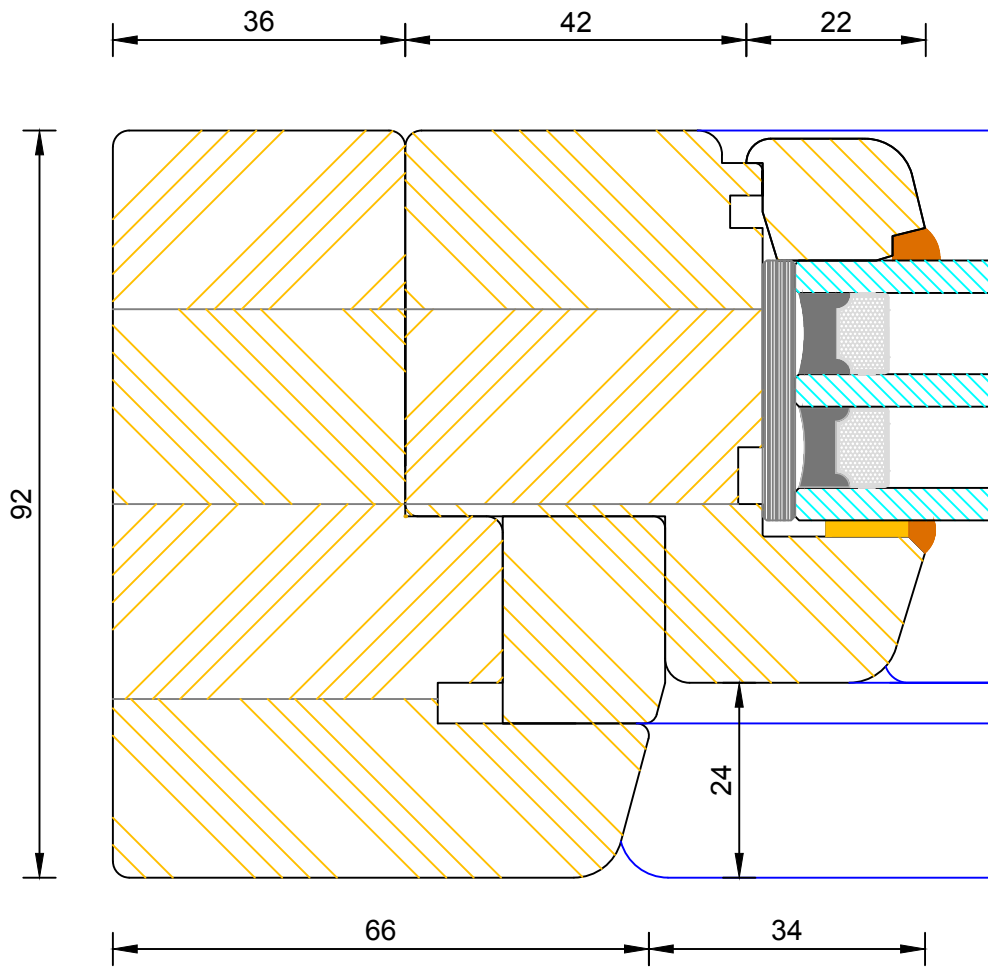

Contemporary Open In Flush Entrance Door
 Triple Glazed - Sidelight / Fanlight Jamb

DIMENSIONS	PLOT SIZE	SCALE	DATE	REV	DWG NO.
MM	A4	1:1	27.01.2011	A	1155

Please consider the environment before printing

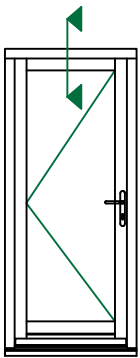
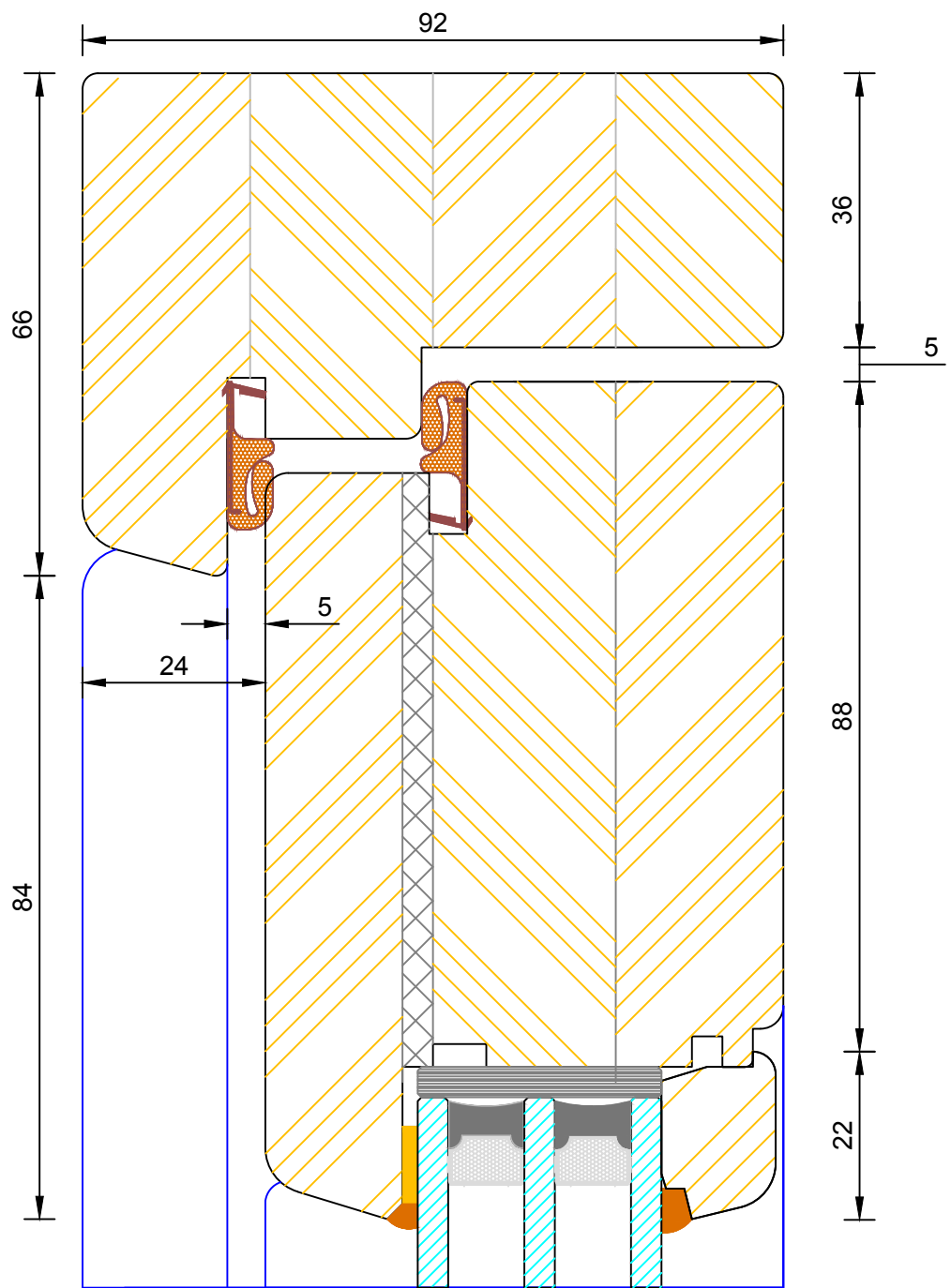

Contemporary Open In Flush Entrance Door
Triple Glazed - Frame & Leaf Head

DIMENSIONS	PLOT SIZE	SCALE	DATE	REV	DWG NO.
MM	A4	1:1	27.01.2011	A	1159

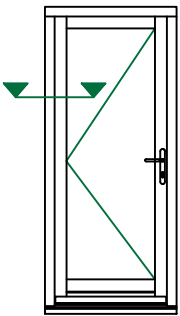
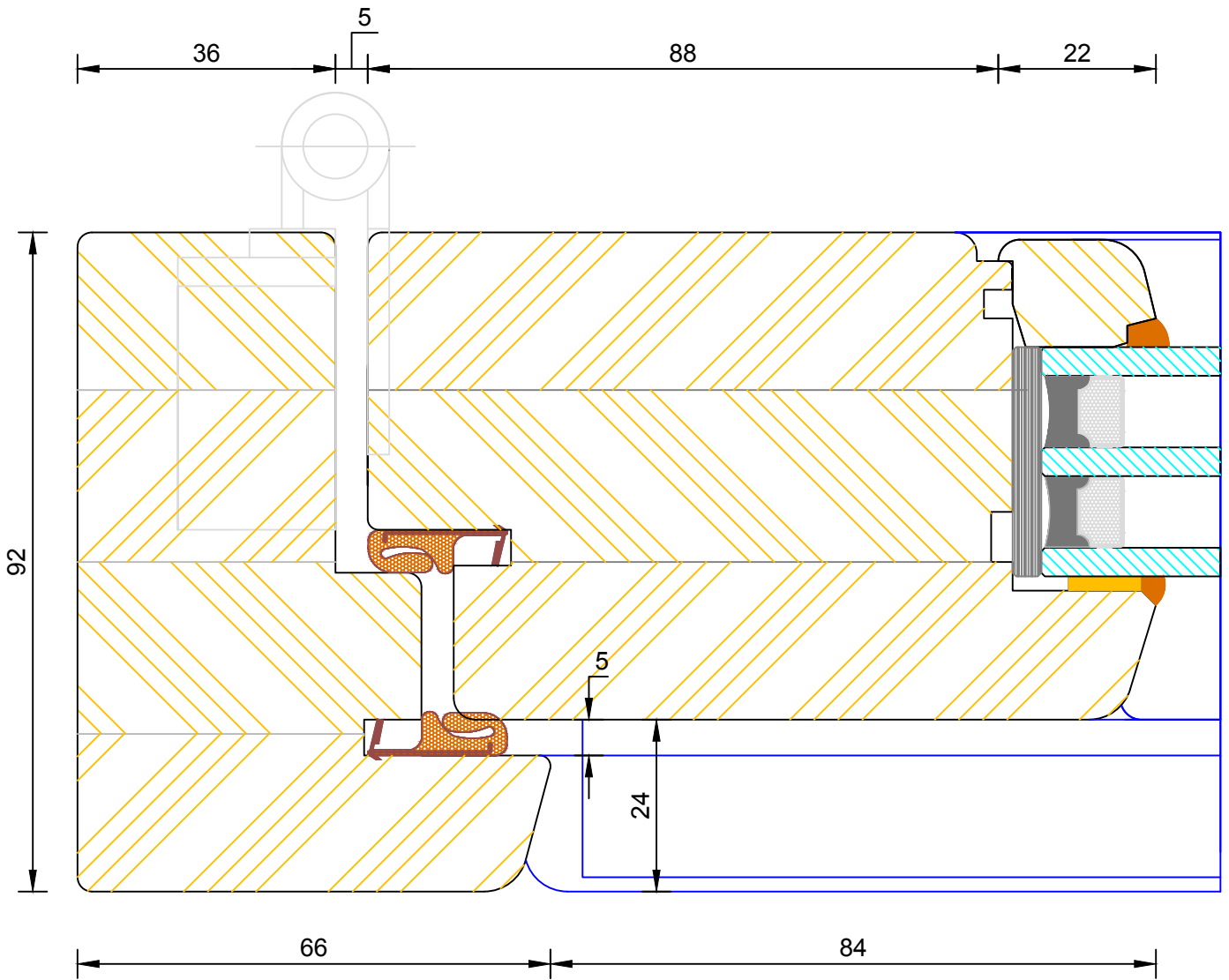

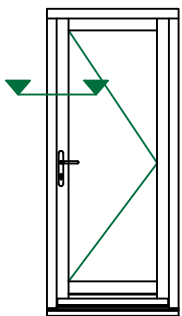
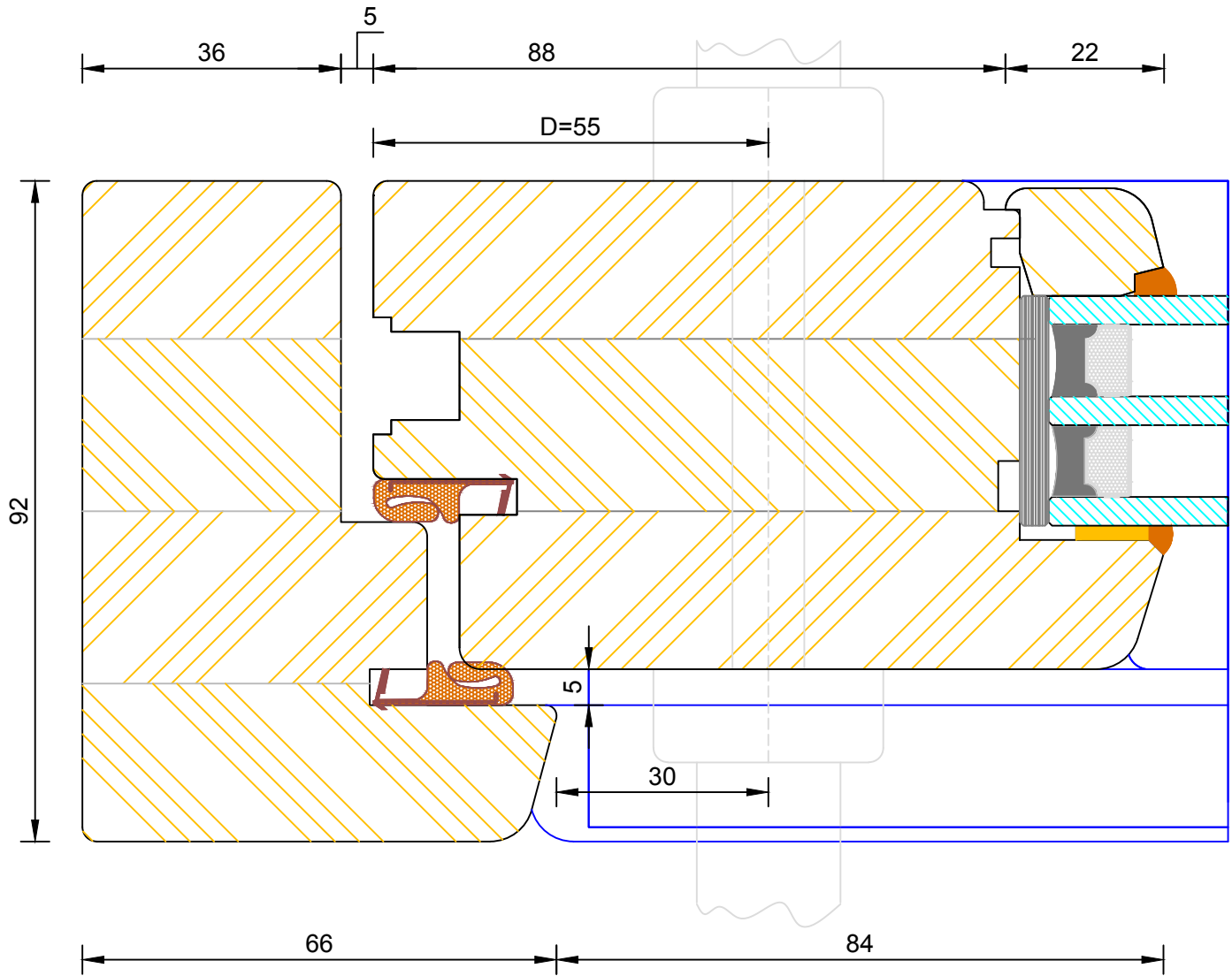

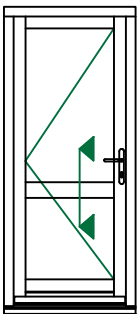
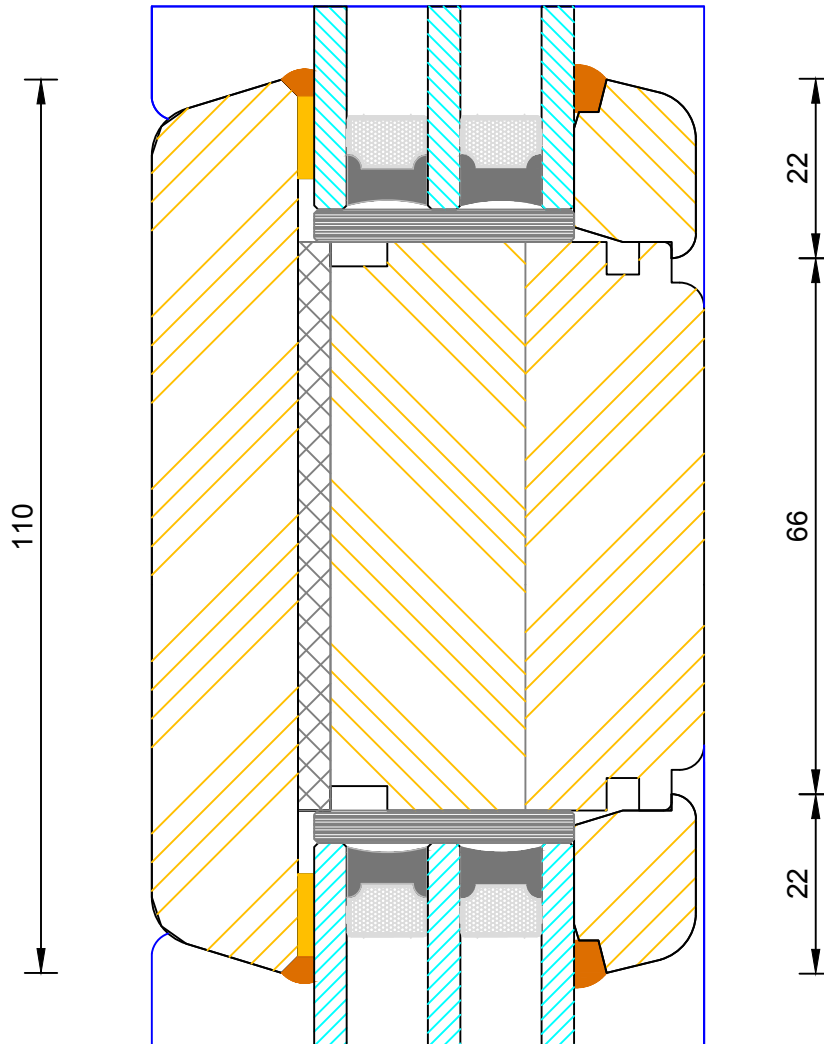

Contemporary Open In Flush Entrance Door
 Triple Glazed - Mid Rail (110mm)

DIMENSIONS	PLOT SIZE	SCALE	DATE	REV	DWG NO.
MM	A4	1:1	27.01.2011	A	1165

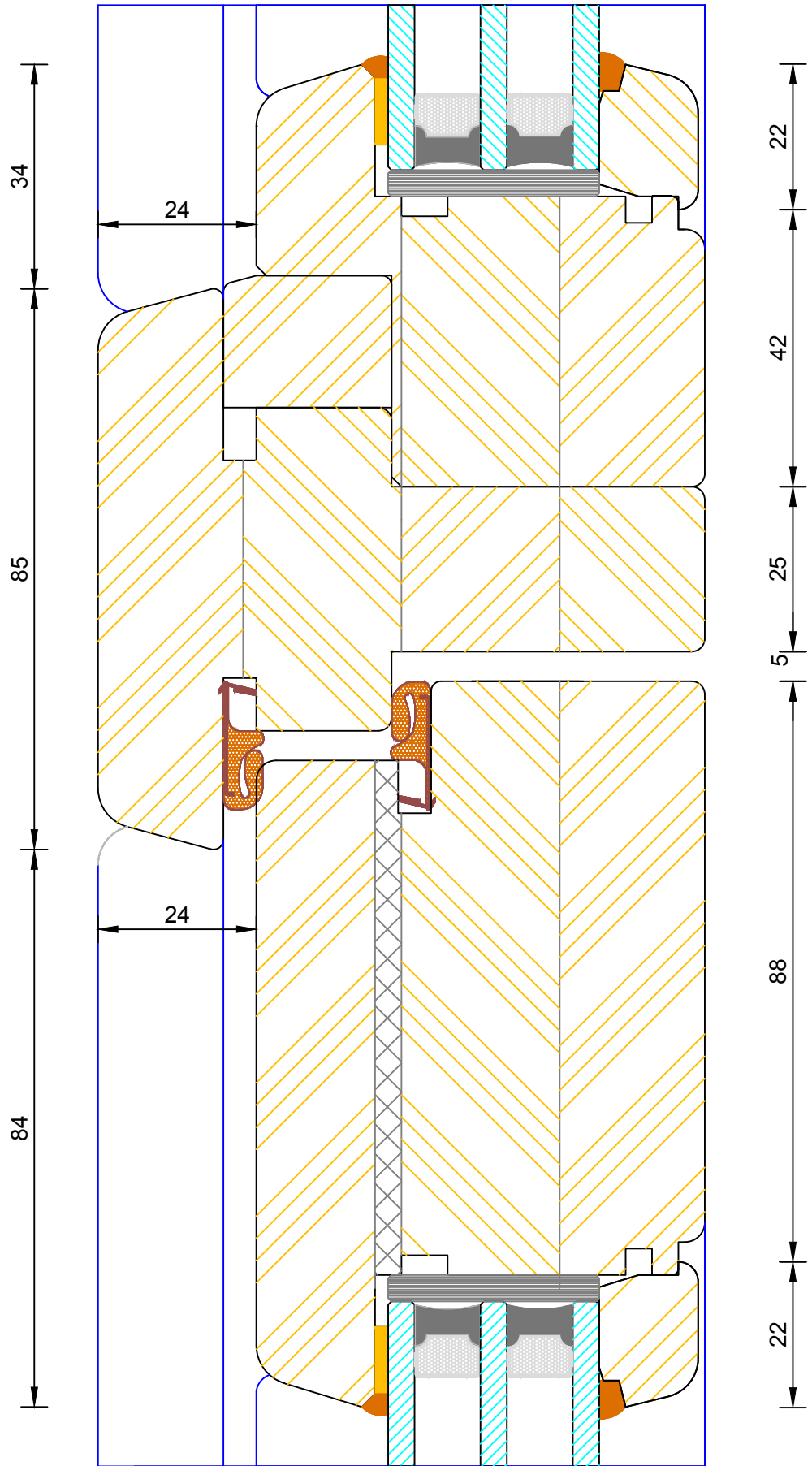
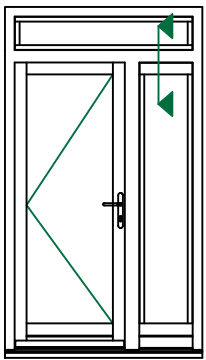

Contemporary Open In Flush Entrance Door
 Triple Glazed - Solid Transom (Fanlight / Sidelight)

DIMENSIONS	PLOT SIZE	SCALE	DATE	REV	DWG NO.
MM	A4	1:1	27.01.2011	A	1166
Please consider the environment before printing					

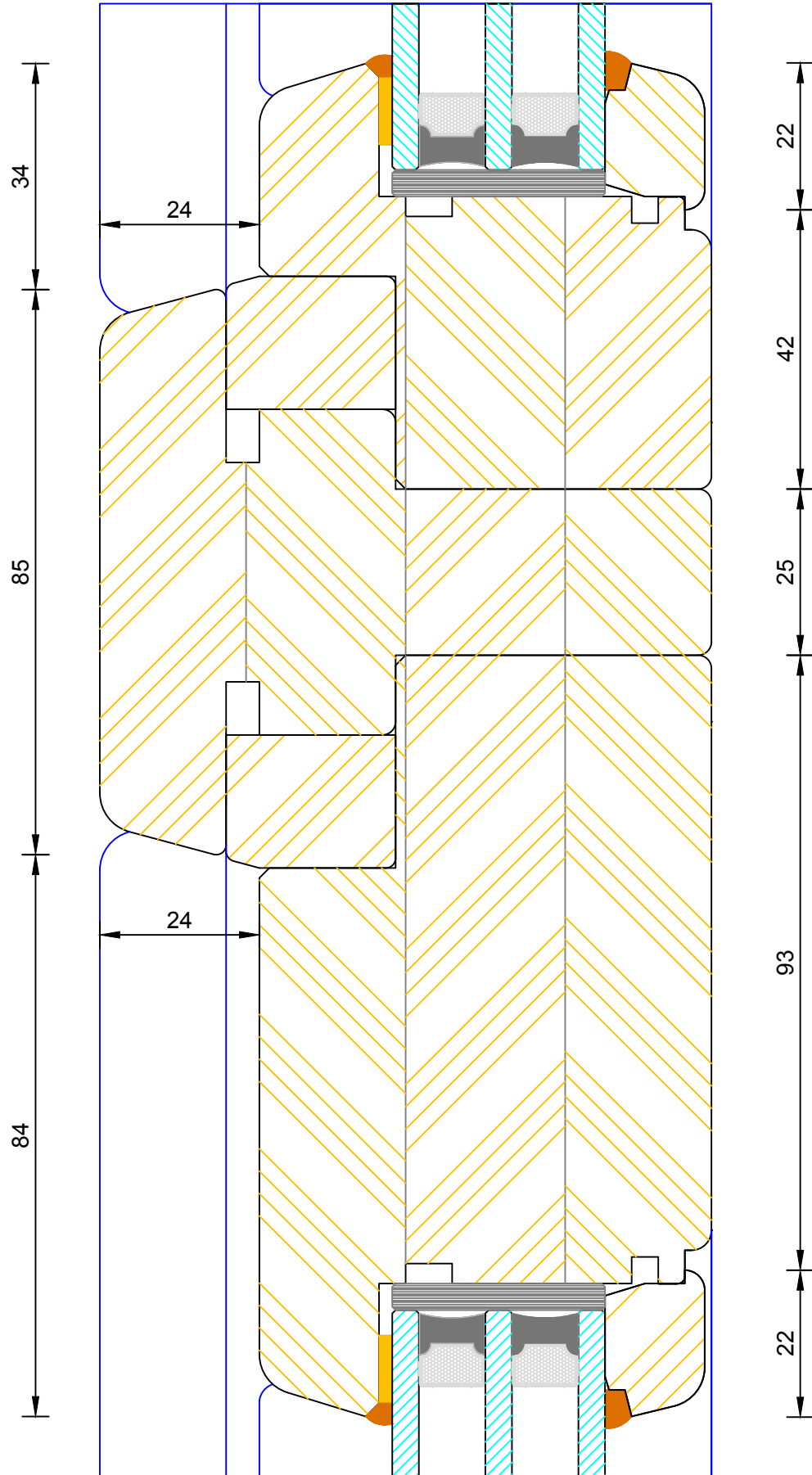
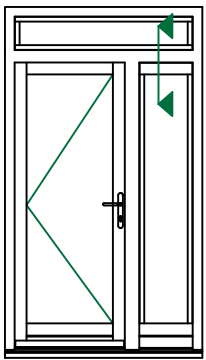

Contemporary Open In Flush Entrance Door
 Triple Glazed - Solid Transom (Fanlight / Door Leaf)

DIMENSIONS	PLOT SIZE	SCALE	DATE	REV	DWG NO.
MM	A4	1:1	27.01.2011	A	1167
Please consider the environment before printing					

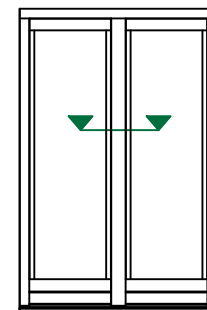
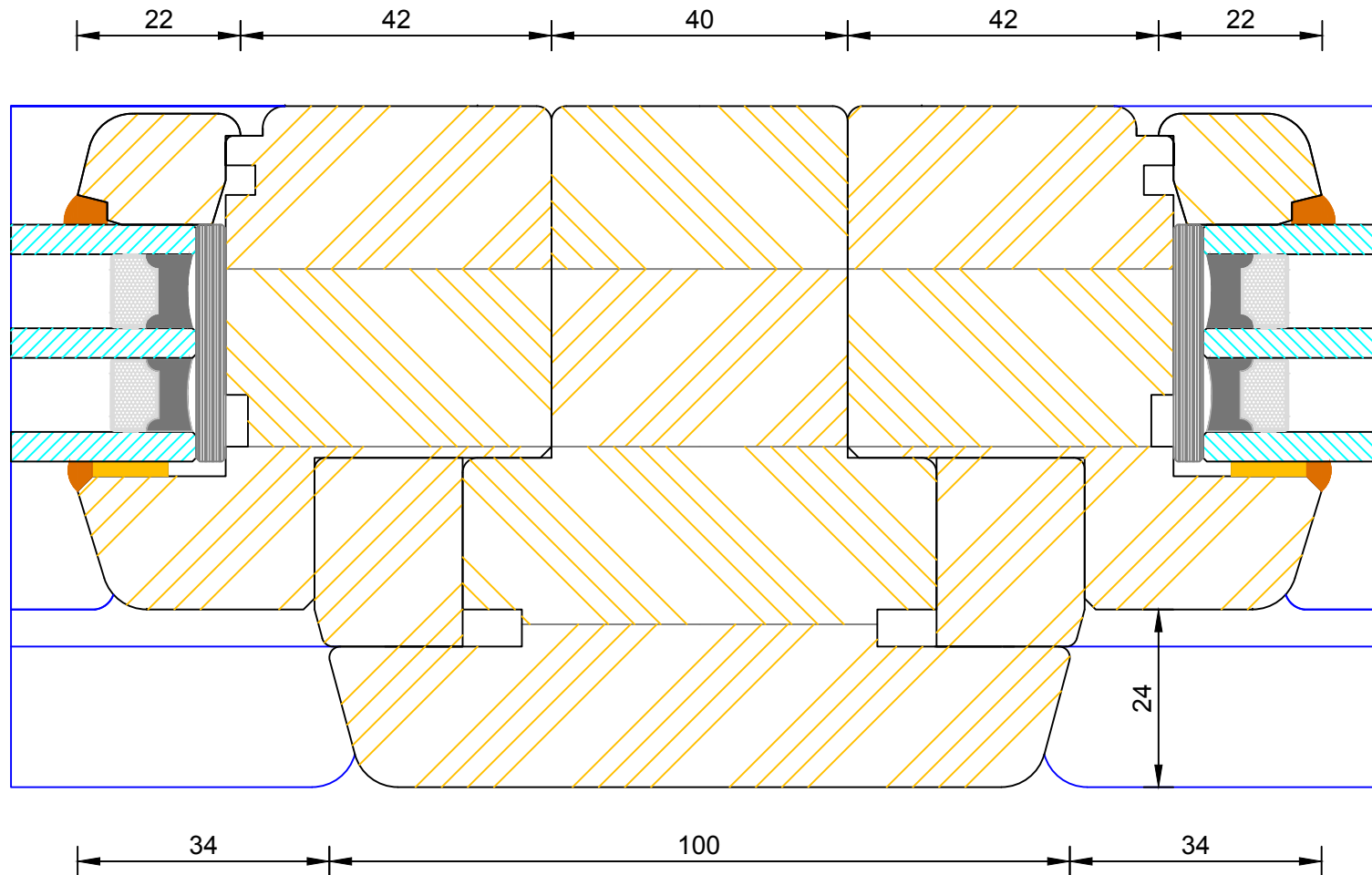

Contemporary Open Out Flush Entrance Door
 Triple Glazed - Solid Mullion (Fixed Light / Fixed Light)

DIMENSIONS	PLOT SIZE	SCALE	DATE	REV	DWG NO.
MM	A4	1:1	07.02.2011	A	1168

Please consider the environment before printing

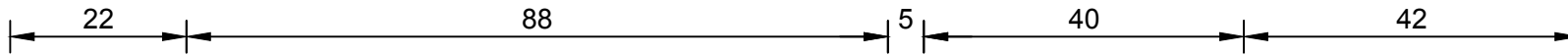

Note: Hinge colour available in Stainless Steel only.

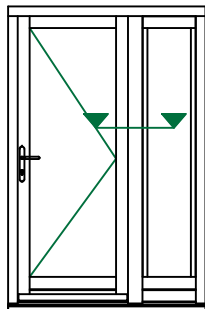
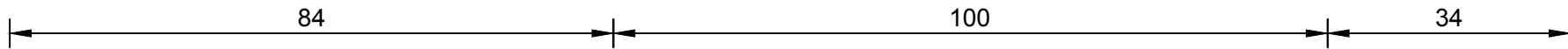
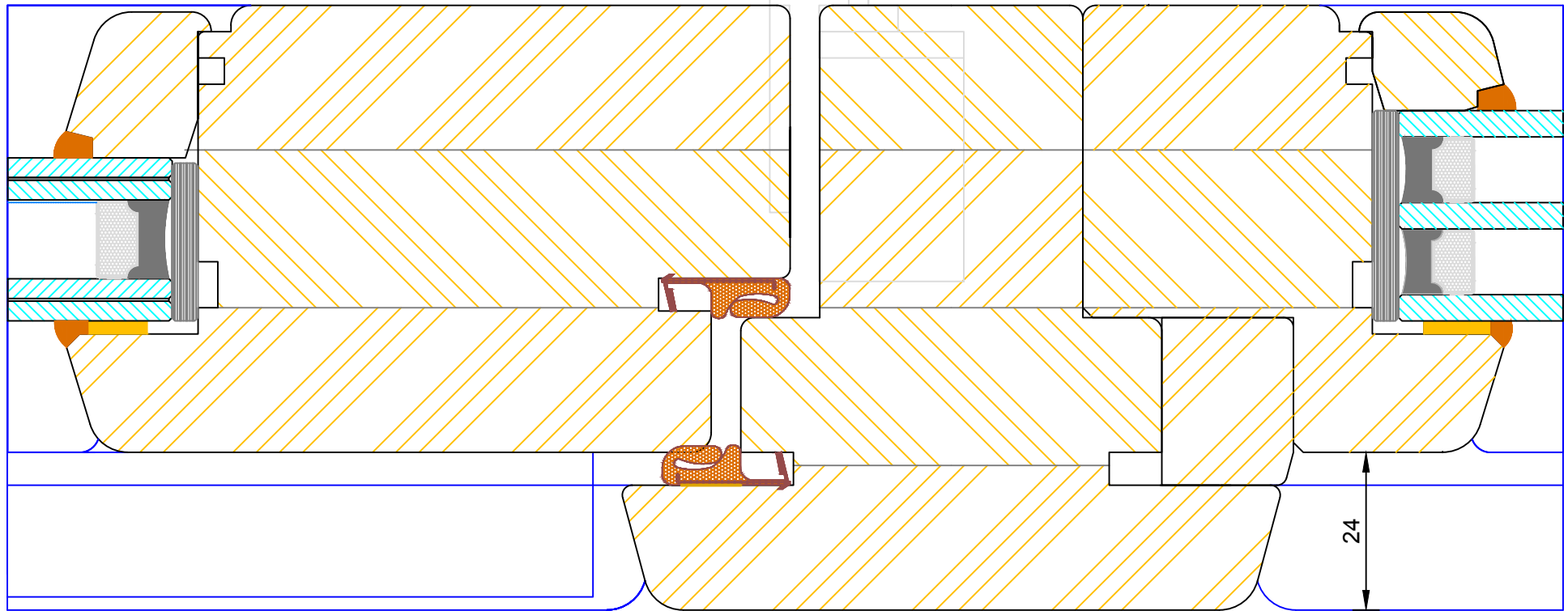

Contemporary Open In Flush Entrance Door
Triple Glazed - Solid Mullion (Leaf / Side Light)

DIMENSIONS	PLOT SIZE	SCALE	DATE	REV	DWG NO.
MM	A4	1:1	07.02.2011	A	1169

Please consider the environment before printing

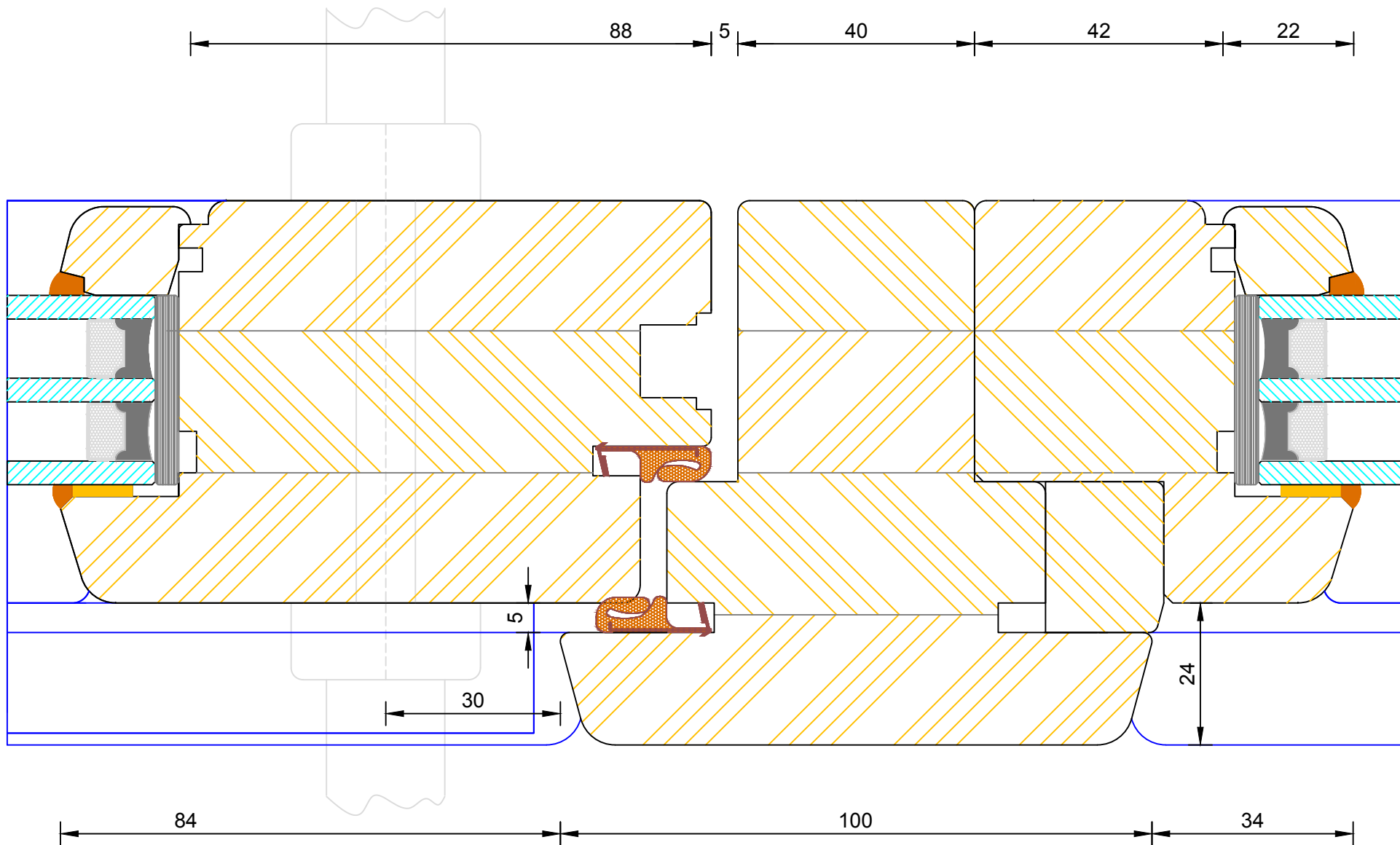

Contemporary Open Out Flush Entrance Door
Triple Glazed - Solid Mullion (Leaf / Side Light)

DIMENSIONS	PLOT SIZE	SCALE	DATE	REV	DWG NO.
MM	A4	1:1	07.02.2011	A	1170
Please consider the environment before printing					

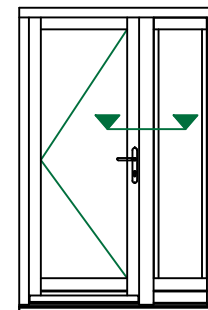

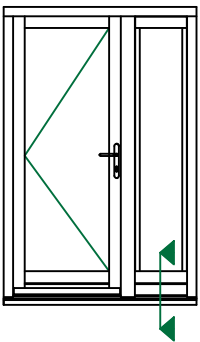
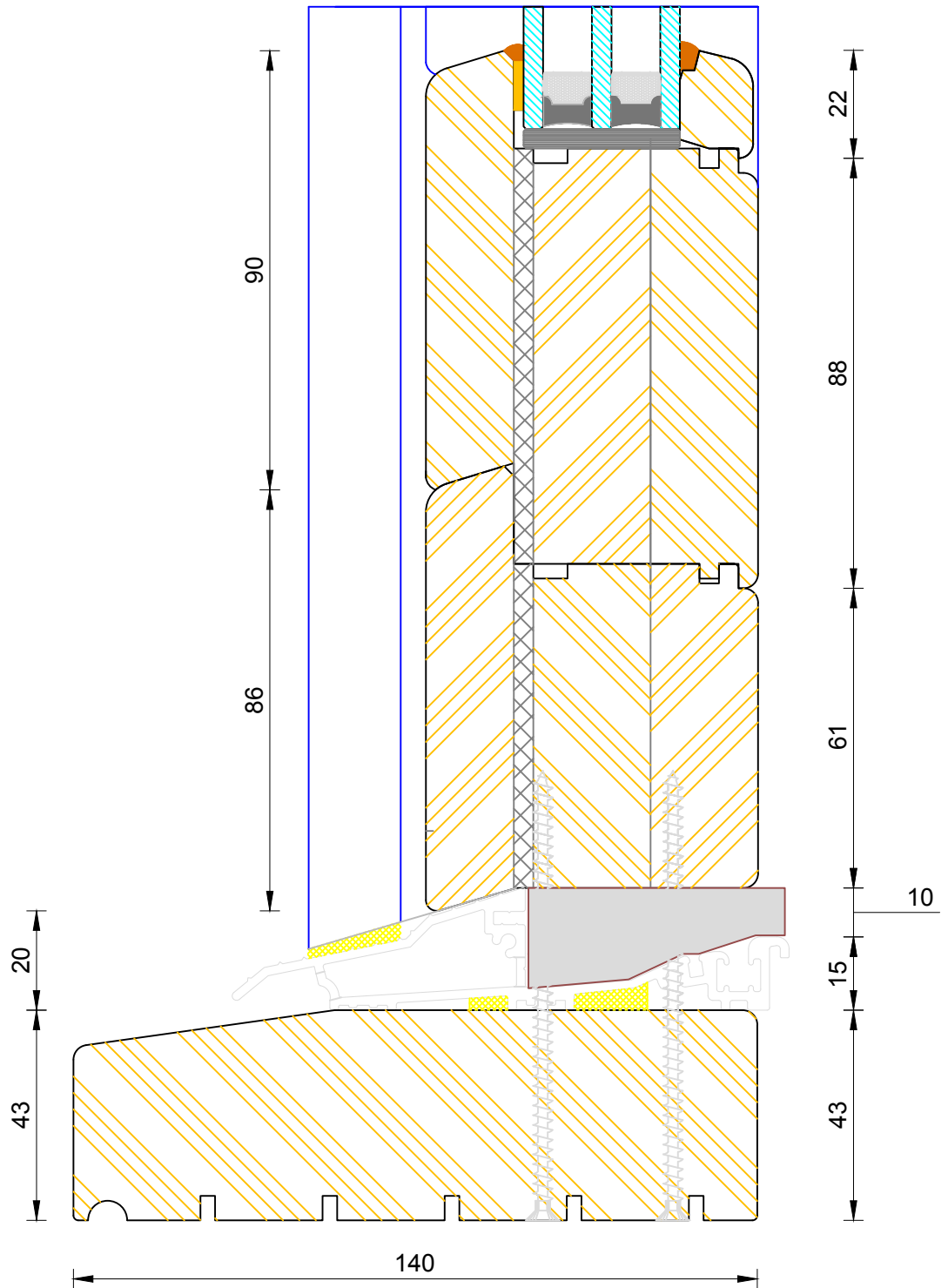

Contemporary Open In Flush Entrance Door
 Triple Glazed - Standard Thresh (Sidelight)

DIMENSIONS	PLOT SIZE	SCALE	DATE	REV	DWG NO.
MM	A3	1:1	27.01.2011	A	1156

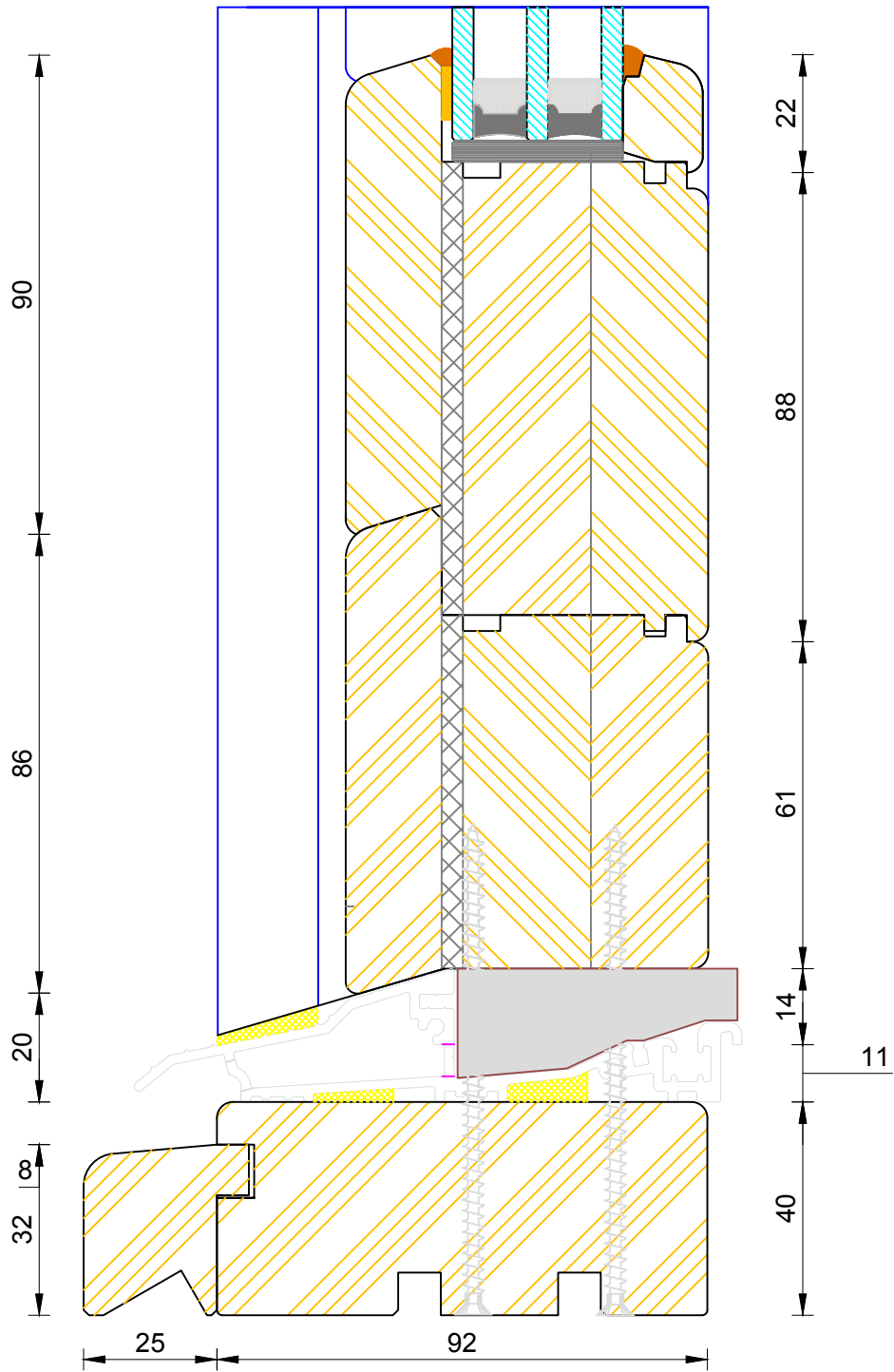

CILL EXTENSION - available options: 25mm (117mm o/a) / 47mm (139mm o/a) / 62mm (154mm o/a) / 87mm (179mm o/a) / 114mm (206mm o/a) / 125mm (217mm o/a) / 140mm (232mm o/a)

NOTE: Cill Extensions should be supported from underneath; the maximum overhang over Brick / Blockwork for cill extension should not exceed 25mm in order to avoid damage when stepped on. Warranties are invalidated when fitted with overhang in excess to that.

If not otherwise stated, Hardwood Threshold will be painted the same colour as Frame.

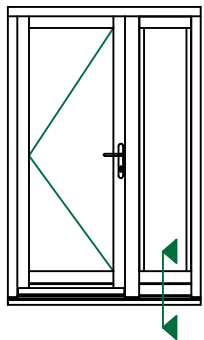

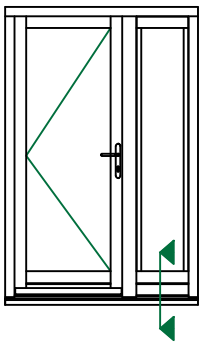
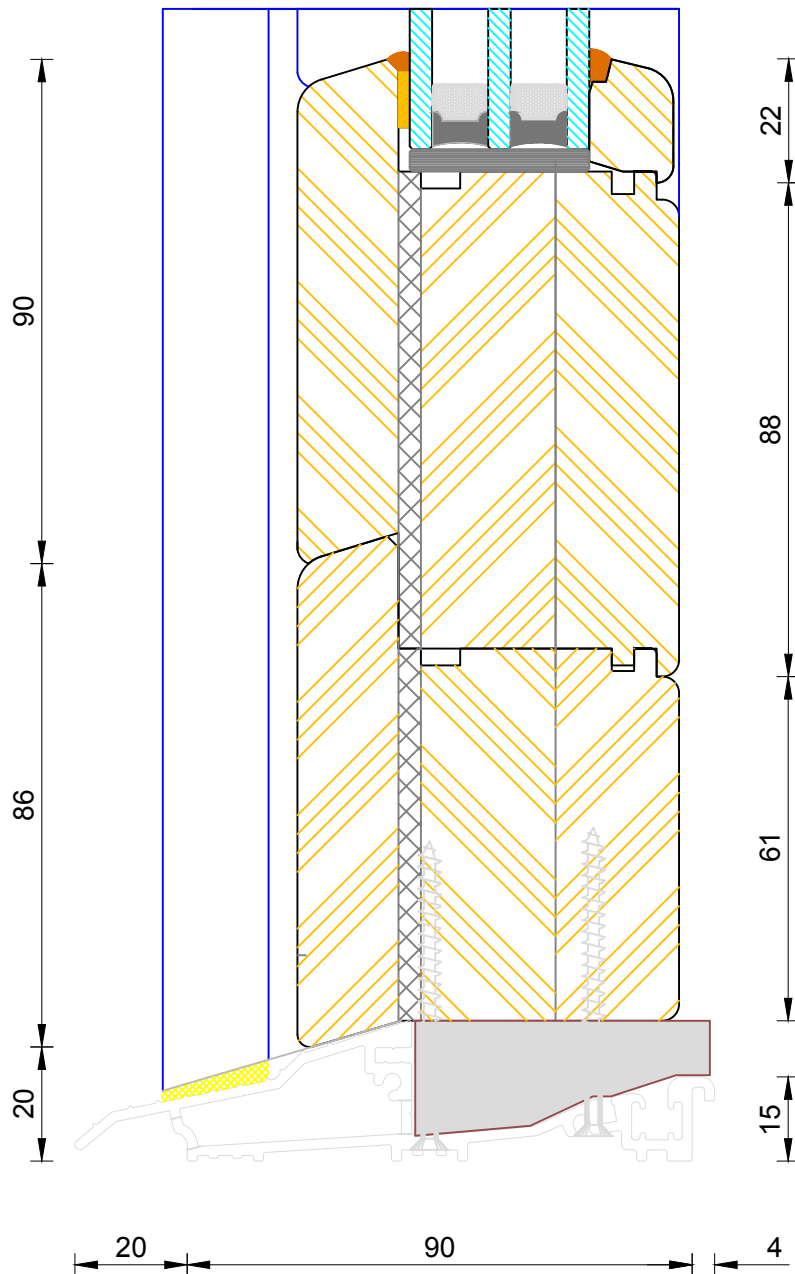

Contemporary Open In Flush Entrance Door
 Triple Glazed - Mobility Thresh (Sidelight)

DIMENSIONS	PLOT SIZE	SCALE	DATE	REV	DWG NO.
MM	A3	1:1	27.01.2011	A	1158

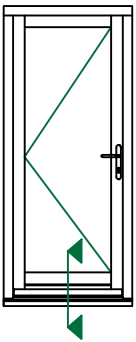
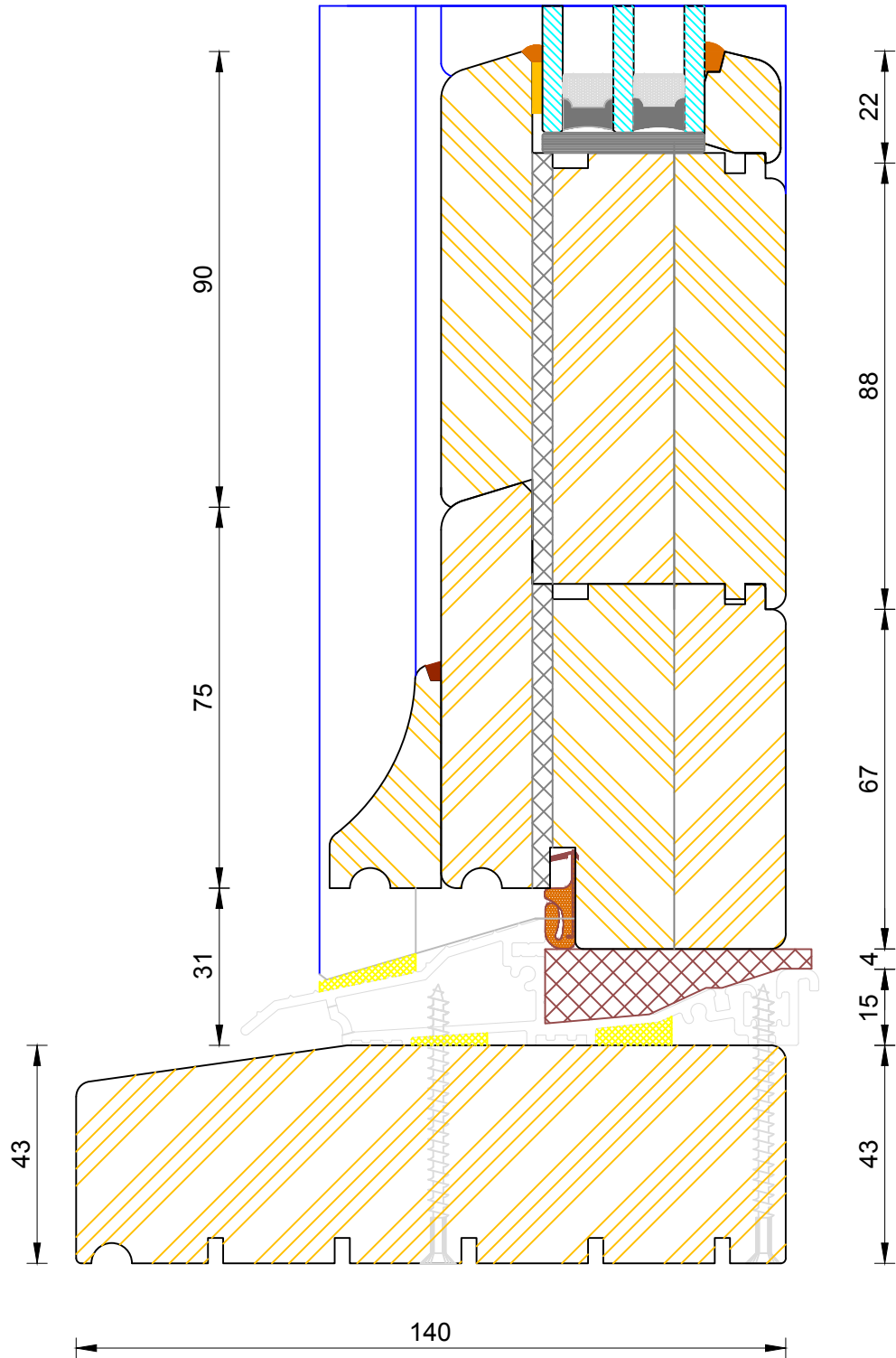

Contemporary Open In Flush Entrance Door
 Triple Glazed - Standard Thresh (140x43mm)

DIMENSIONS	PLOT SIZE	SCALE	DATE	REV	DWG NO.
MM	A3	1:1	27.01.2011	A	1162

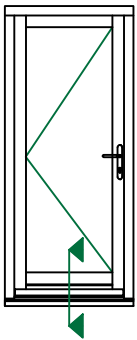
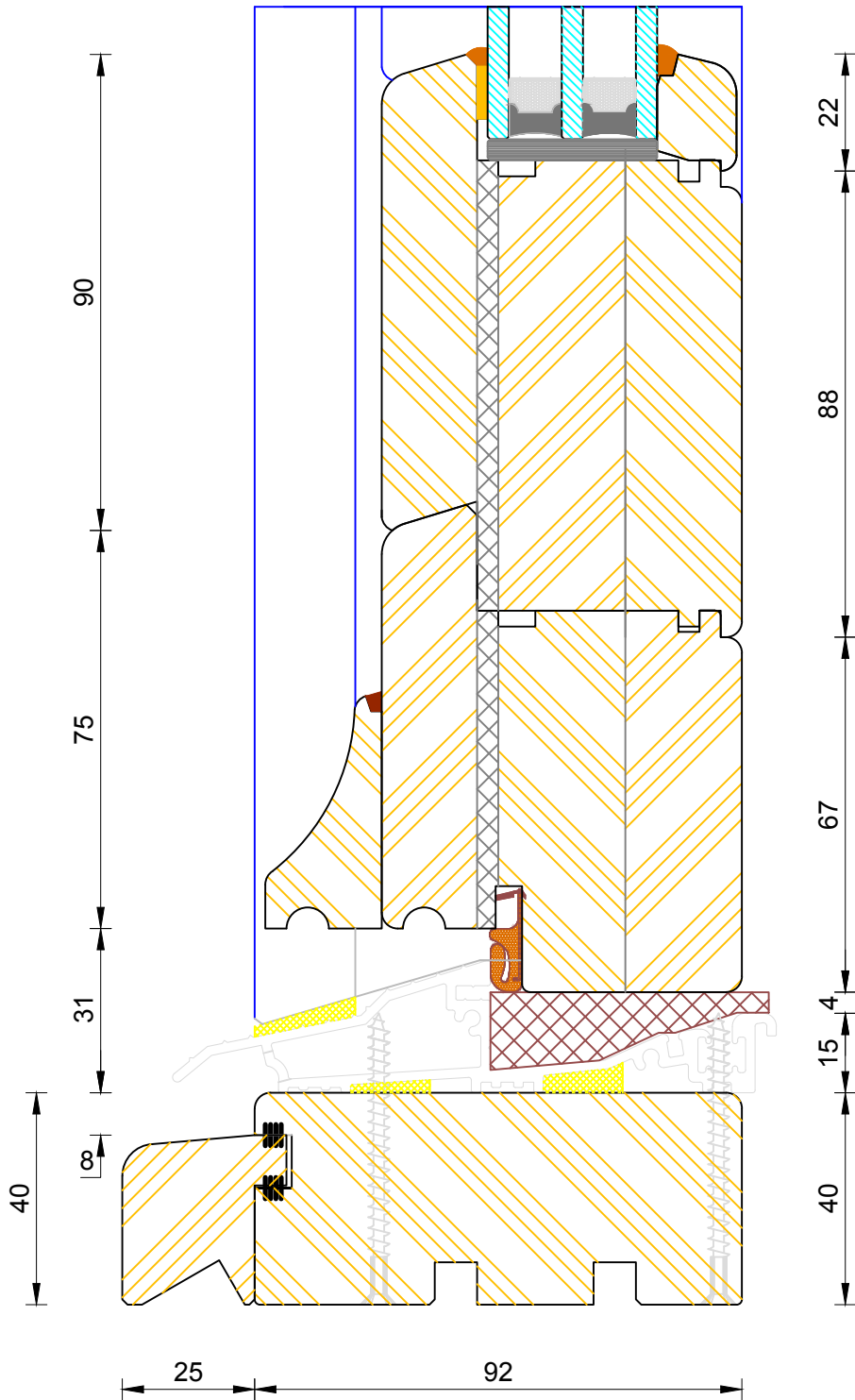

CILL EXTENSION - available options: 25mm (117mm o/a) / 47mm (139mm o/a) / 62mm (154mm o/a) / 87mm (179mm o/a) / 114mm (206mm o/a) / 125mm (217mm o/a) / 140mm (232mm o/a)

NOTE: Cill Extensions should be supported from underneath; the maximum overhang over Brick / Blockwork for cill extension should not exceed 25mm in order to avoid damage when stepped on. Warrenties are invalidated when fitted with overhang in excess to that.

If not otherwise stated, Hardwood Threshold will be painted the same colour as Frame.

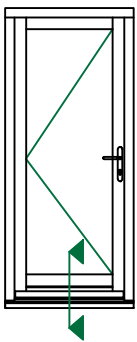
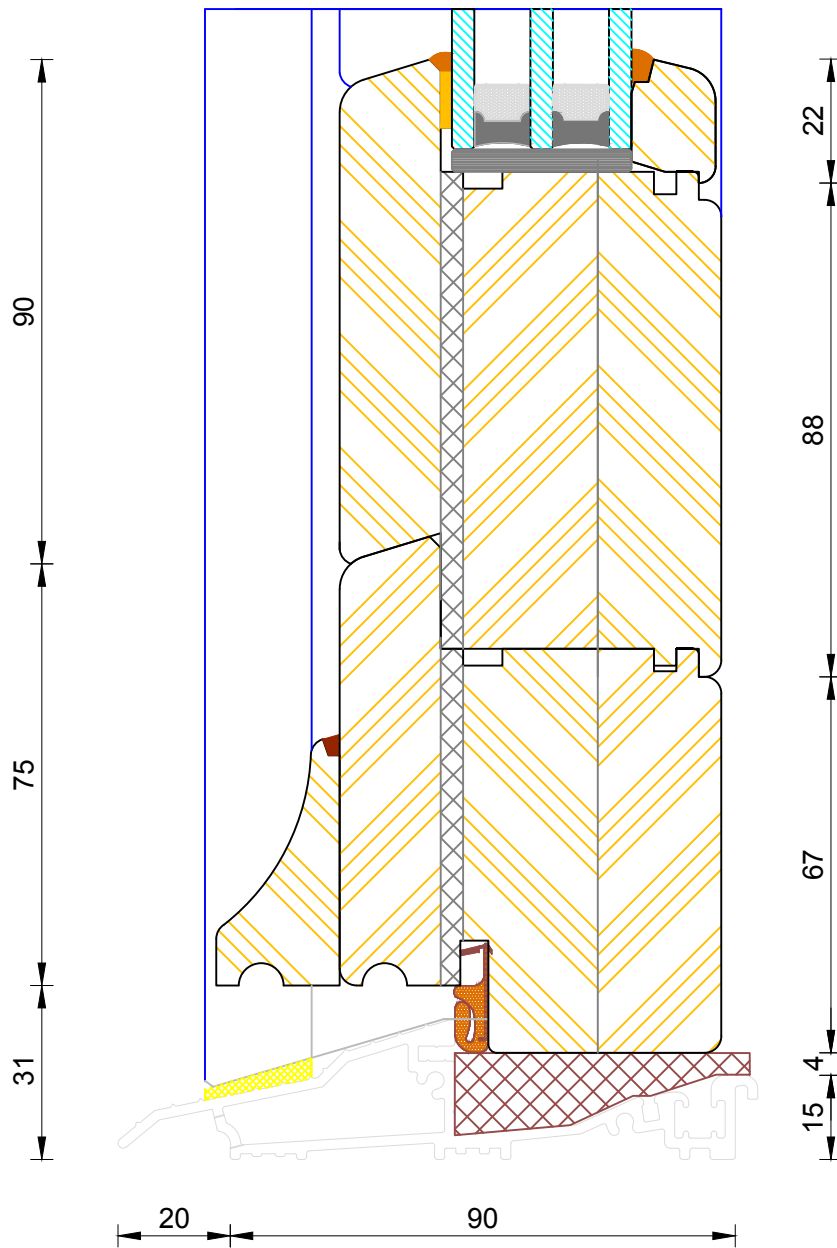

**Contemporary Open In Flush Entrance Door
Triple Glazed - Mobility Thresh**

DIMENSIONS	PLOT SIZE	SCALE	DATE	REV	DWG NO.
MM	A3	1:1	27.01.2011	A	1164
Please consider the environment before printing					