

### Contemporary Open Out Lipped French Door Cill Extension Options

DIMENSIONS	PLOT SIZE	SCALE	DATE	REV	DWG NO.
MM	A4	1:1	25.09.2019	B	<b>1201</b>
Please consider the environment before printing					

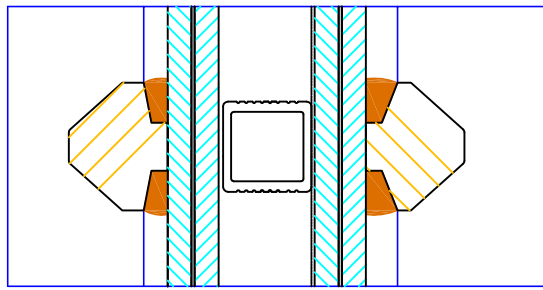

16

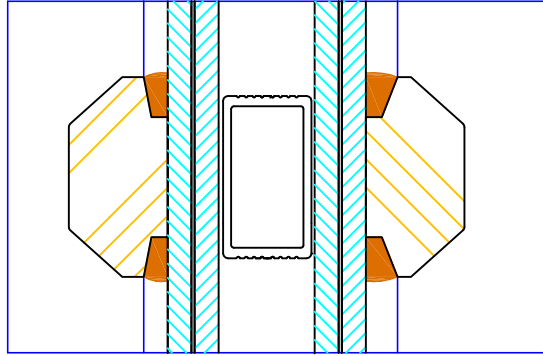

25

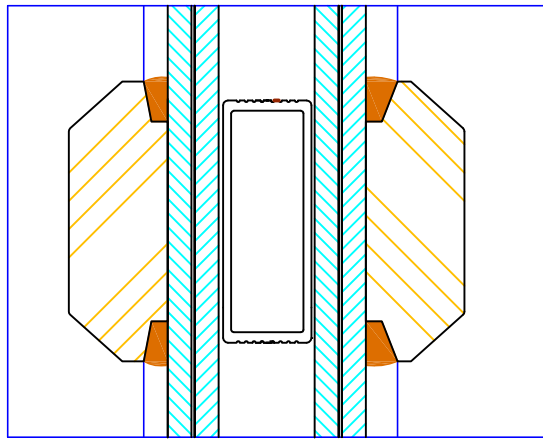

35

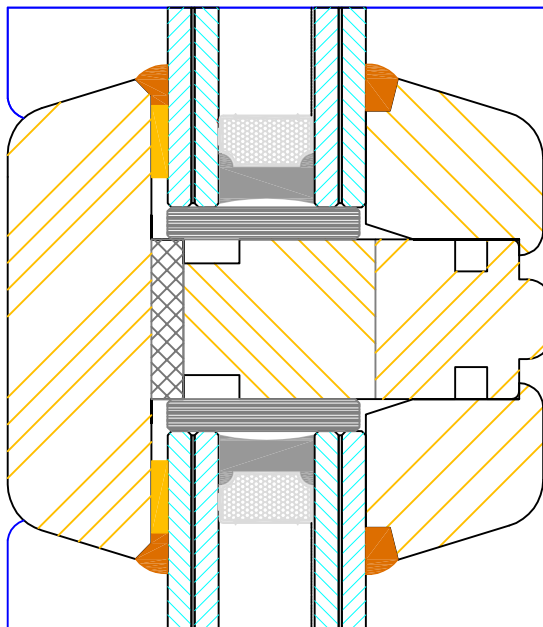

60 (varies mOut 60/ max 137mm)

22 16 22

DIMENSIONS	PLOT SIZE	SCALE	DATE	REV	DWG NO.
MM	A4	1:1	07.02.2011	A	<b>1202</b>

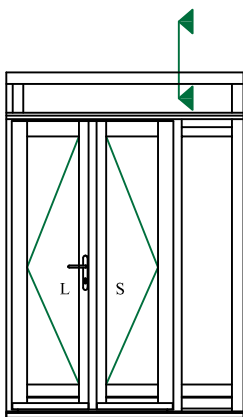
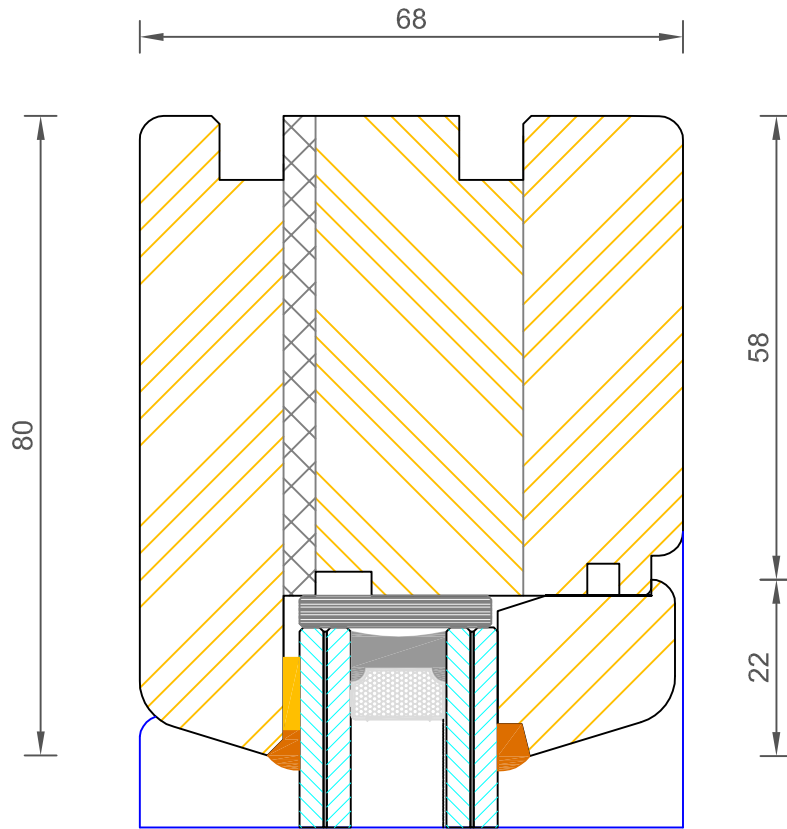

DIMENSIONS	PLOT SIZE	SCALE	DATE	REV	DWG NO.
MM	A4	1:1	07.02.2011	A	<b>1203</b>
Please consider the environment before printing					

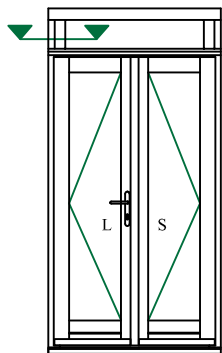
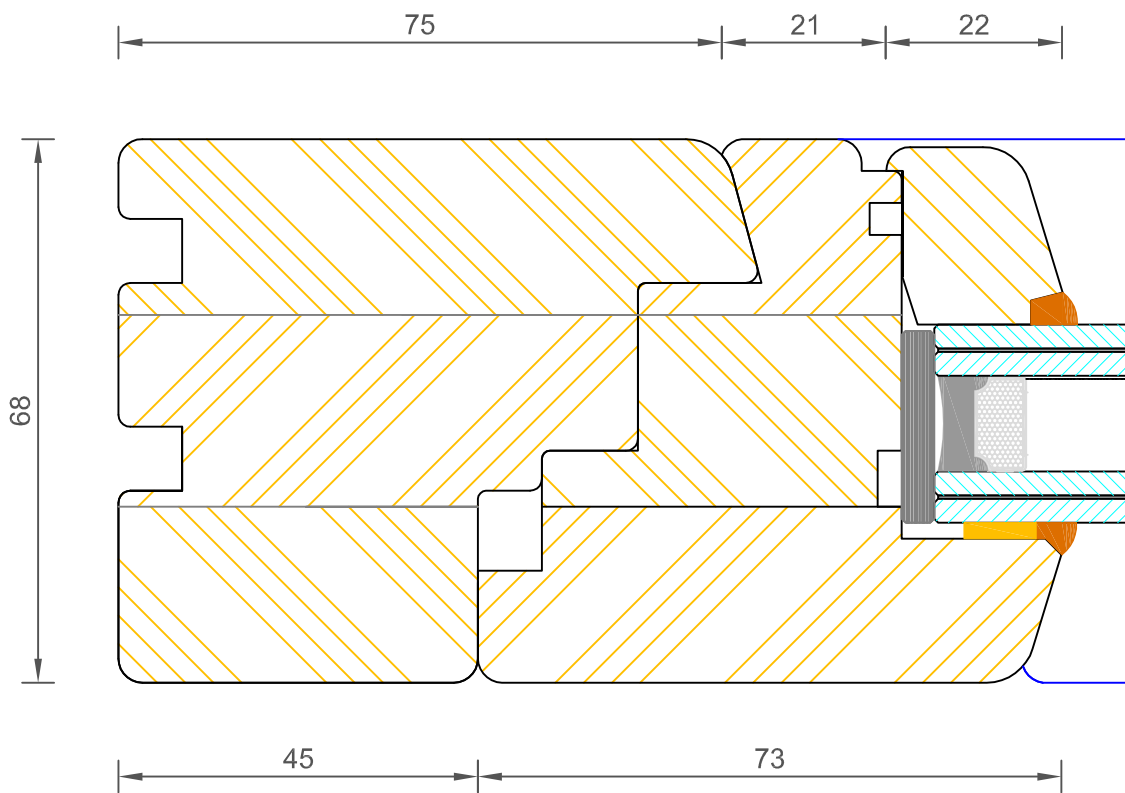

**Contemporary Open Out Lipped French Door  
Fanlight Jamb**

DIMENSIONS	PLOT SIZE	SCALE	DATE	REV	DWG NO.
MM	A4	1:1	07.02.2011	A	<b>1204</b>
Please consider the environment before printing					

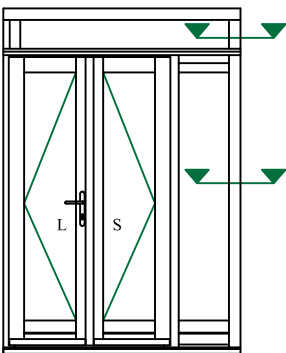
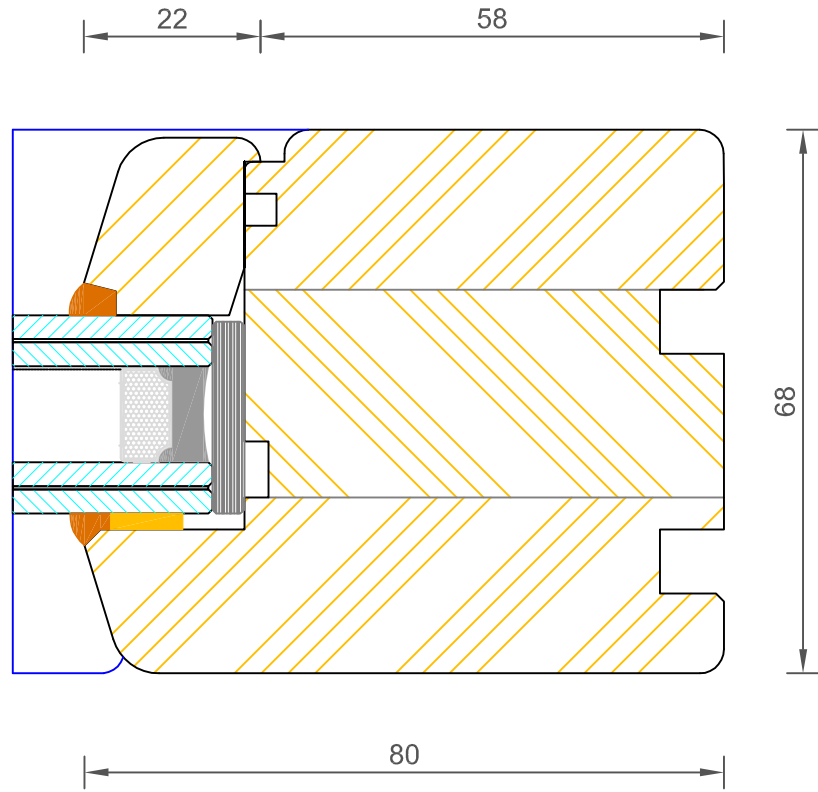

**Contemporary Open Out Lipped French Door  
Sidelight Jamb**

DIMENSIONS	PLOT SIZE	SCALE	DATE	REV	DWG NO.
MM	A4	1:1	07.02.2011	A	<b>1205</b>
Please consider the environment before printing					

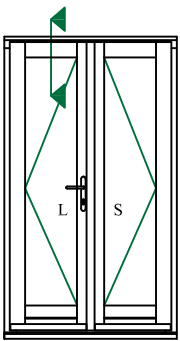
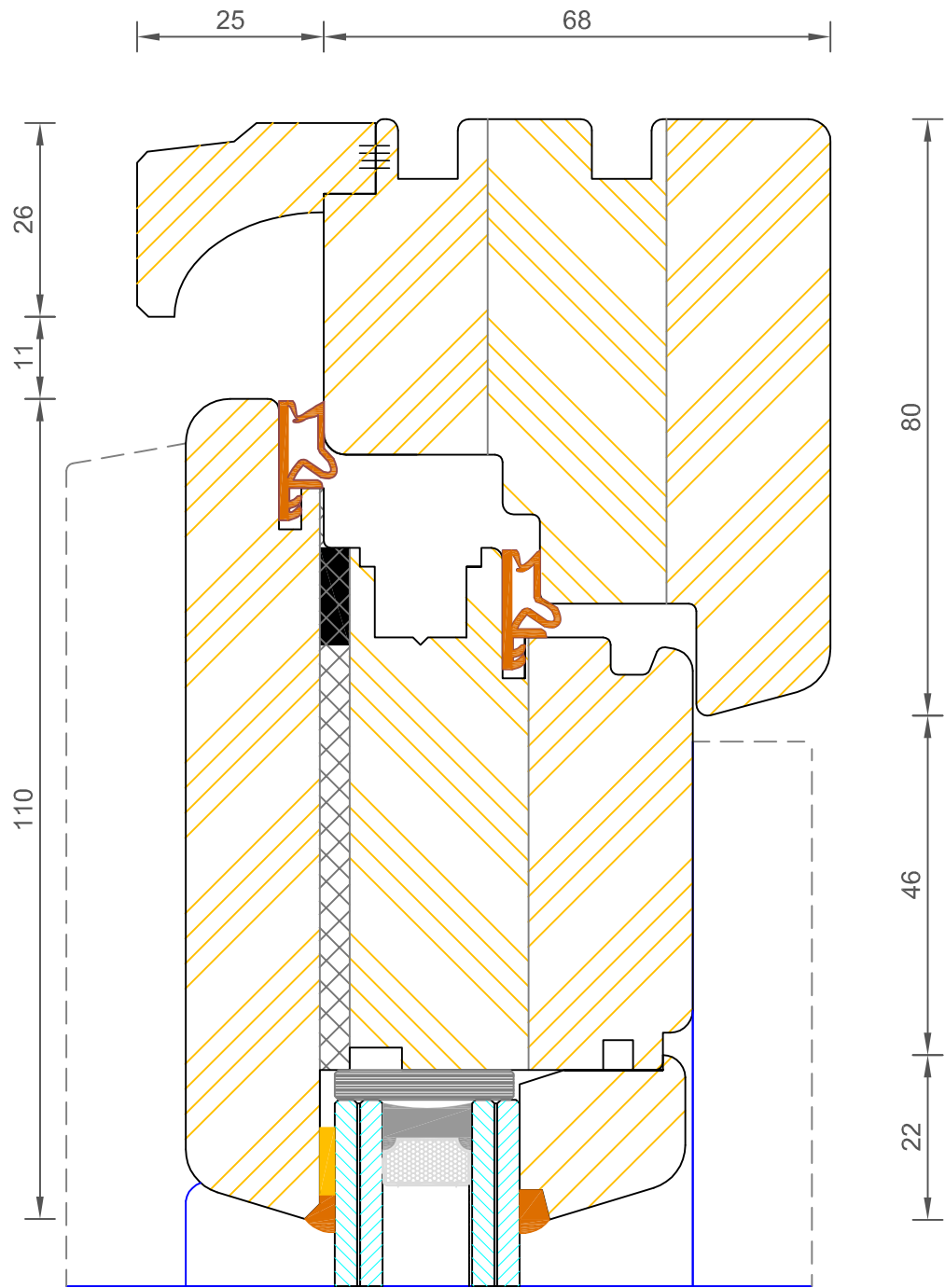

**Contemporary Open Out Lipped French Door  
Frame & Leaf Head (Without Vent)**

DIMENSIONS	PLOT SIZE	SCALE	DATE	REV	DWG NO.
MM	A4	1:1	07.02.2011	A	<b>1209</b>

Please consider the environment before printing

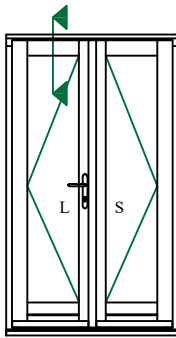
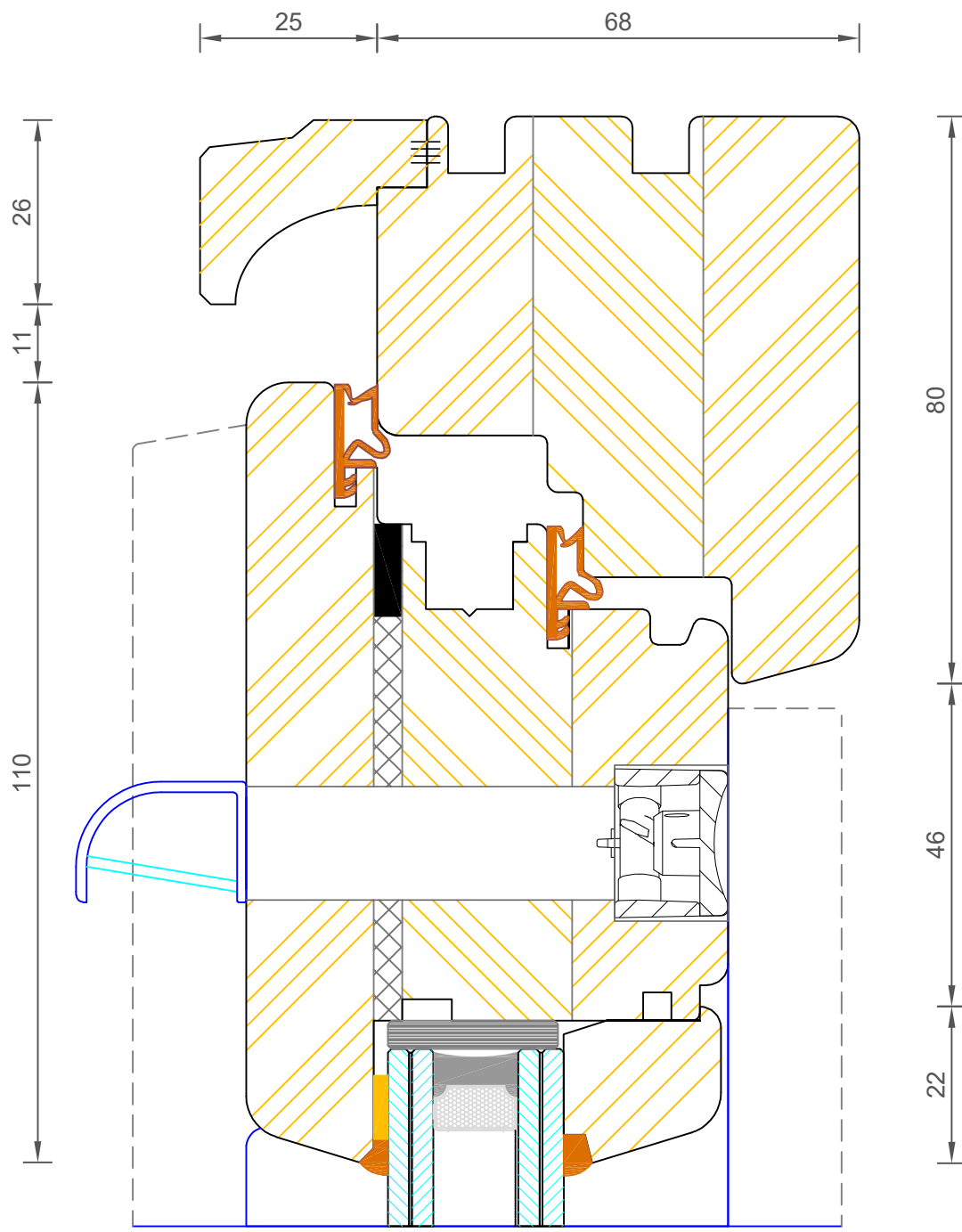

**Contemporary Open Out Lipped French Door  
Frame & Leaf (With Vent in Top Rail)**

DIMENSIONS	PLOT SIZE	SCALE	DATE	REV	DWG NO.
MM	A4	1:1	04.07.2022	B	<b>1210</b>
Please consider the environment before printing					

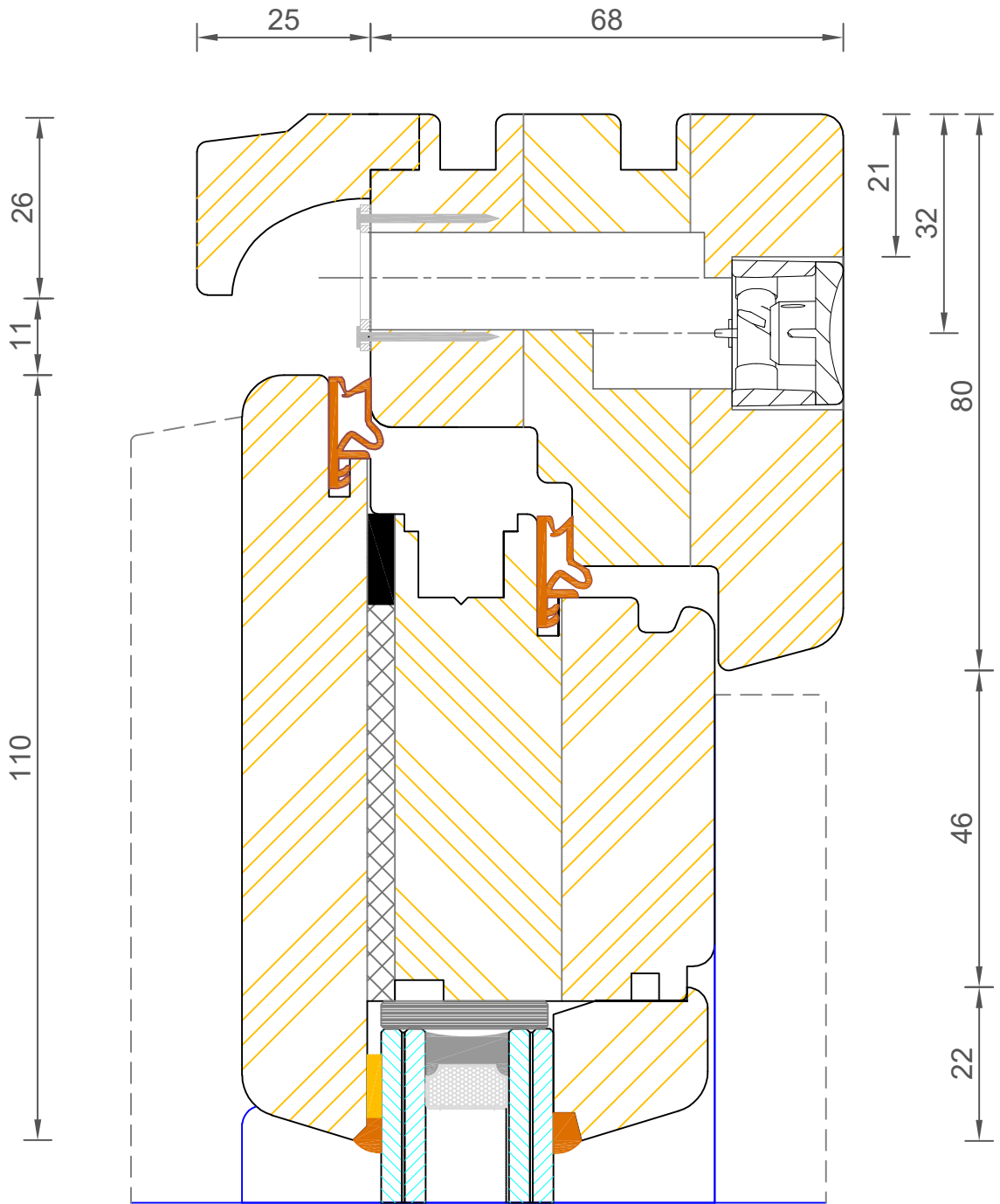
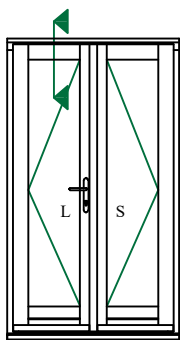

### Contemporary Open Out Lipped French Door Frame & Leaf (With Vent in Frame Head)

DIMENSIONS	PLOT SIZE	SCALE	DATE	REV	DWG NO.
MM	A4	1:1	04.07.2022	B	<b>1210.1</b>
Please consider the environment before printing					



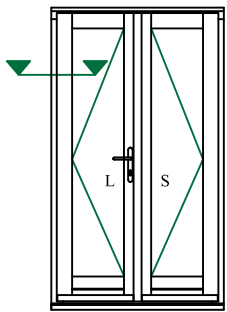
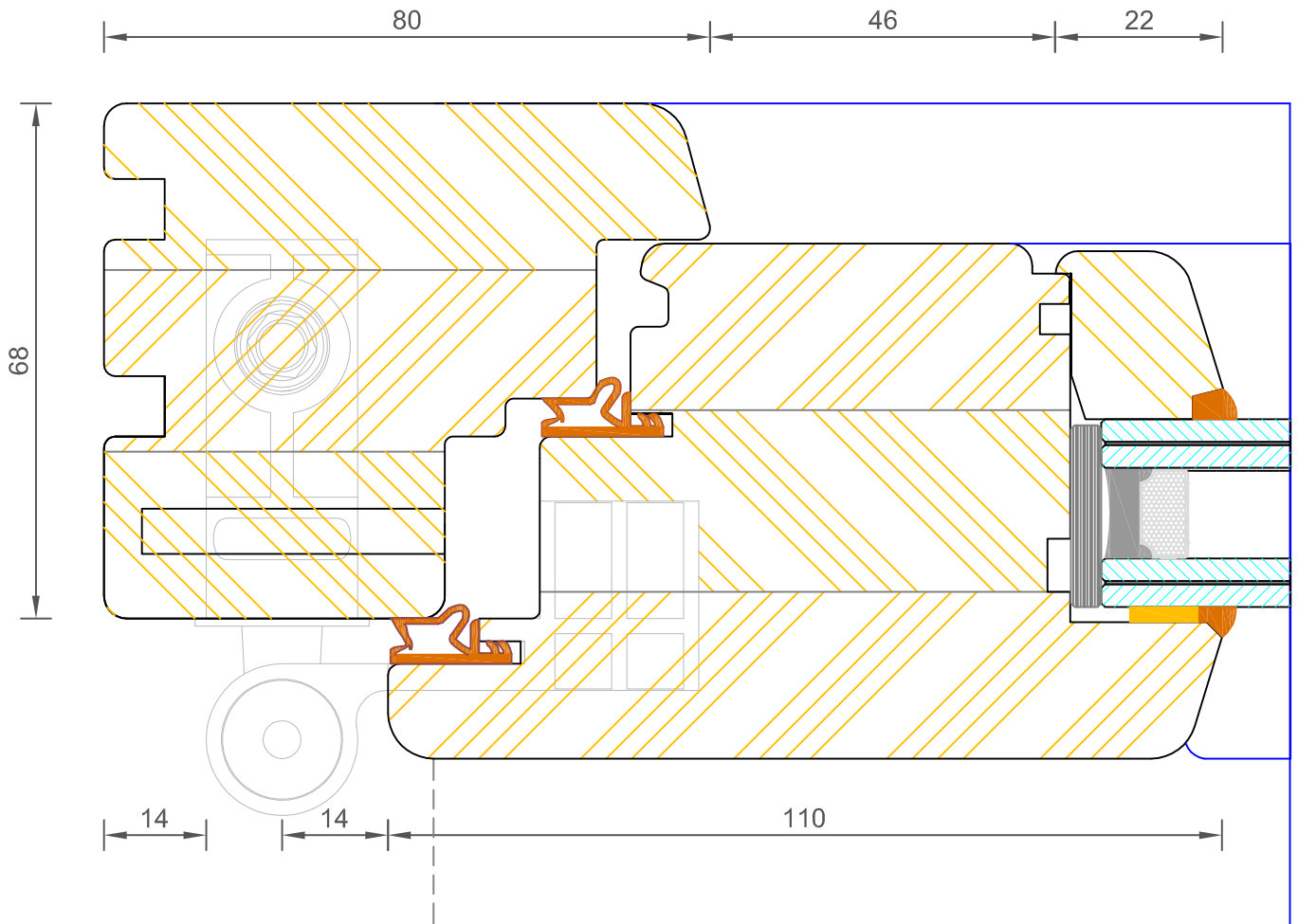

**Contemporary Open Out Lipped French Door  
Frame & Leaf Jamb (80mm)**

DIMENSIONS	PLOT SIZE	SCALE	DATE	REV	DWG NO.
MM	A4	1:1	07.02.2011	A	<b>1211</b>
 Please consider the environment before printing					

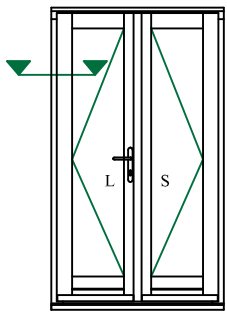
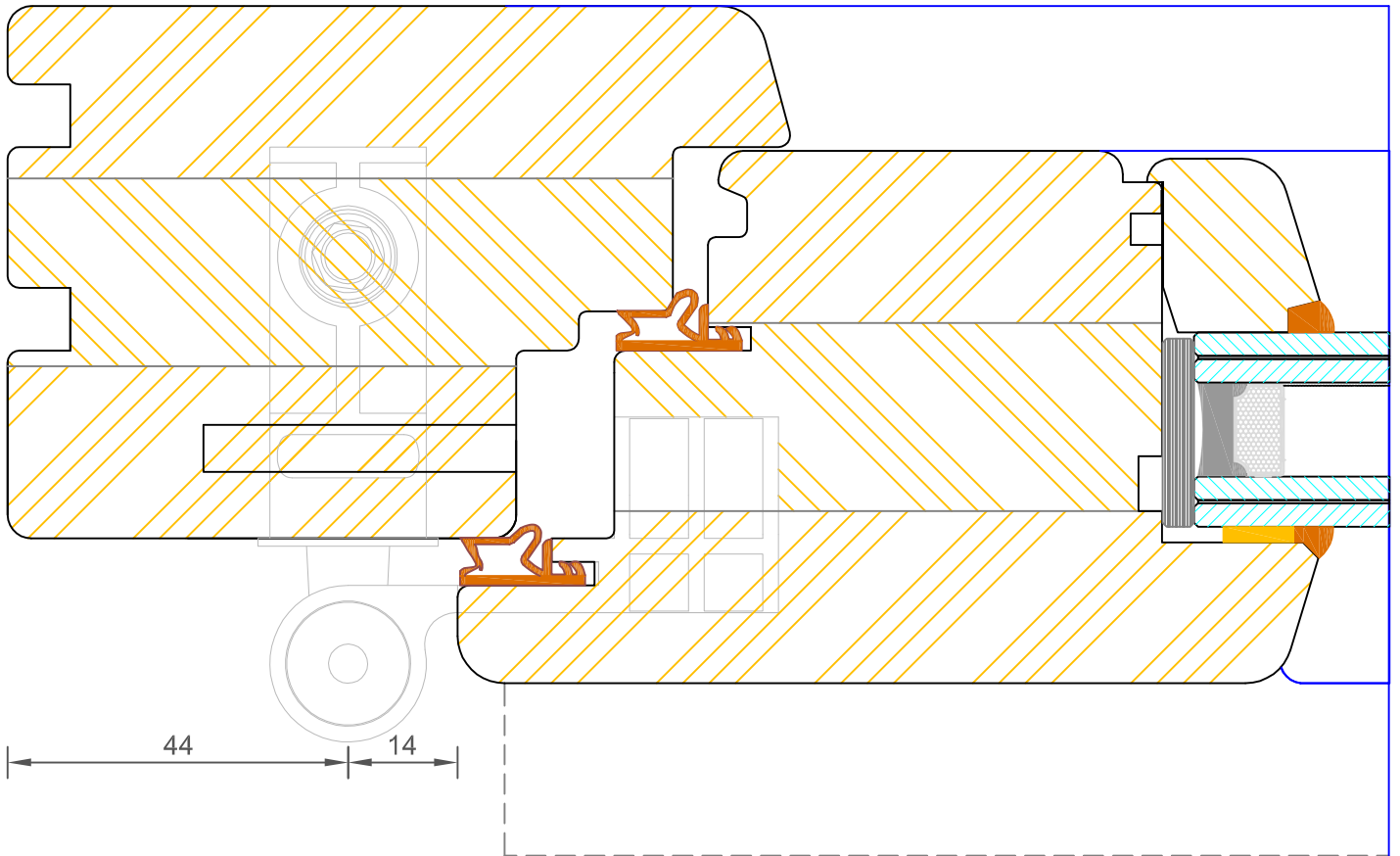

**Contemporary Open Out Lipped French Door  
Frame & Leaf Jamb (100mm)**

DIMENSIONS	PLOT SIZE	SCALE	DATE	REV	DWG NO.
MM	A4	1:1	07.02.2011	A	<b>1211.1</b>
Please consider the environment before printing					

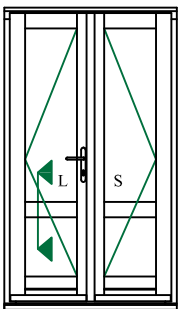
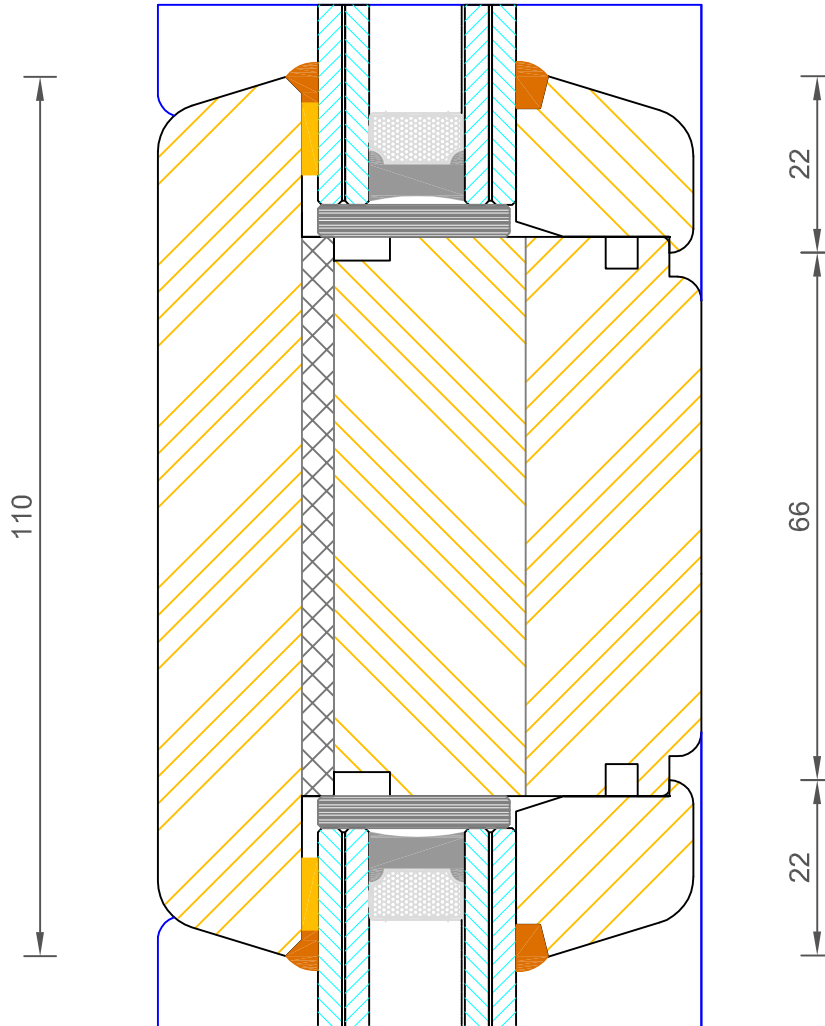

### Contemporary Open Out Lipped French Door Mid Rail

DIMENSIONS	PLOT SIZE	SCALE	DATE	REV	DWG NO.
MM	A4	1:1	07.02.2011	A	<b>1215</b>
 Please consider the environment before printing					

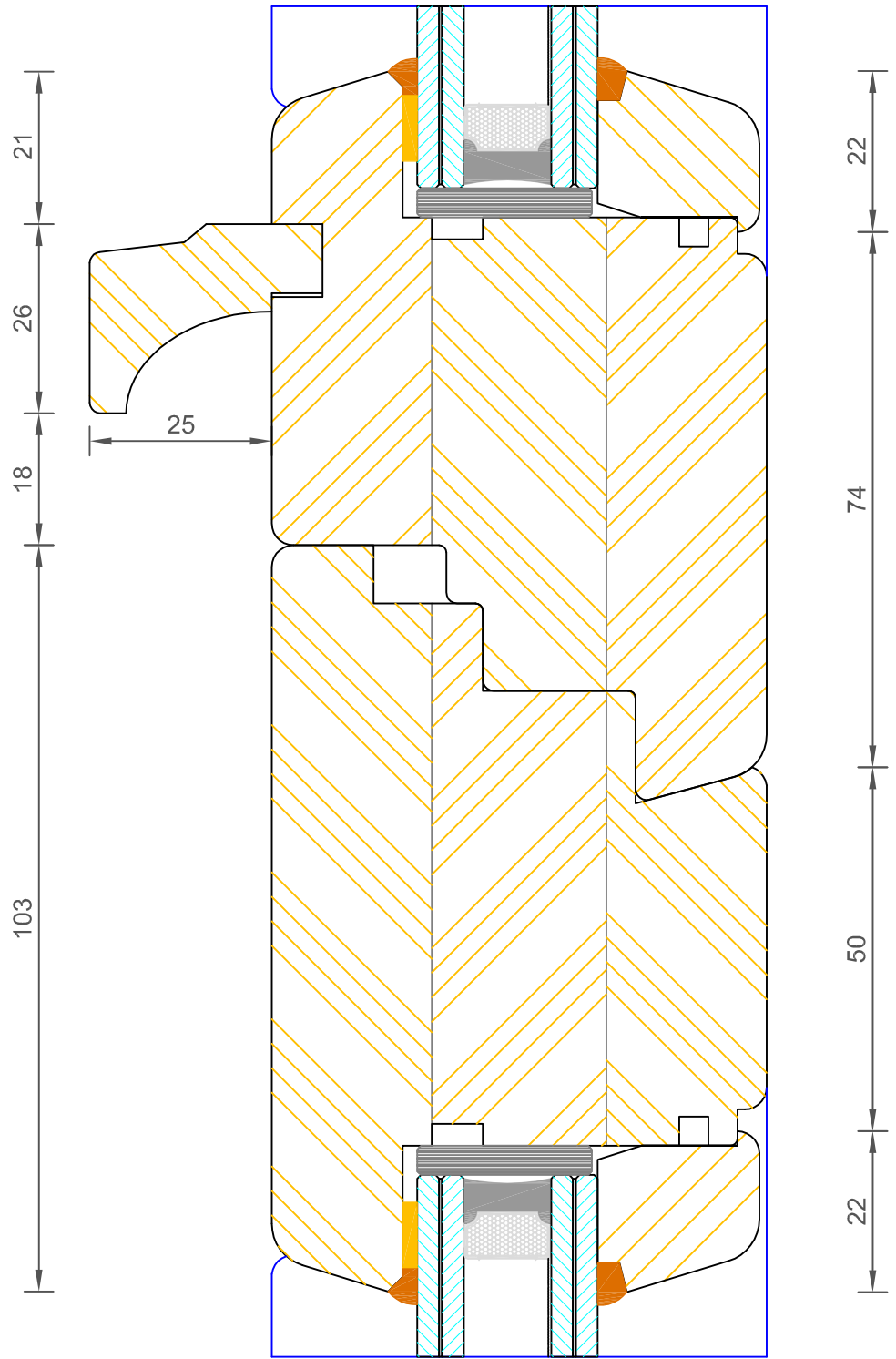
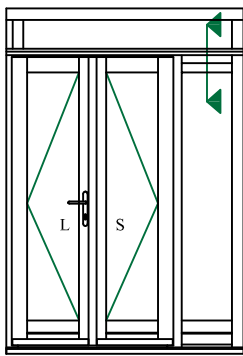

**Contemporary Open Out Lipped French Door  
Fanlight / Sidelight Transom**

DIMENSIONS	PLOT SIZE	SCALE	DATE	REV	DWG NO.
MM	A4	1:1	07.02.2011	A	<b>1216</b>
Please consider the environment before printing					

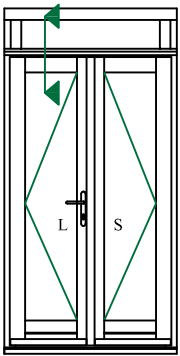
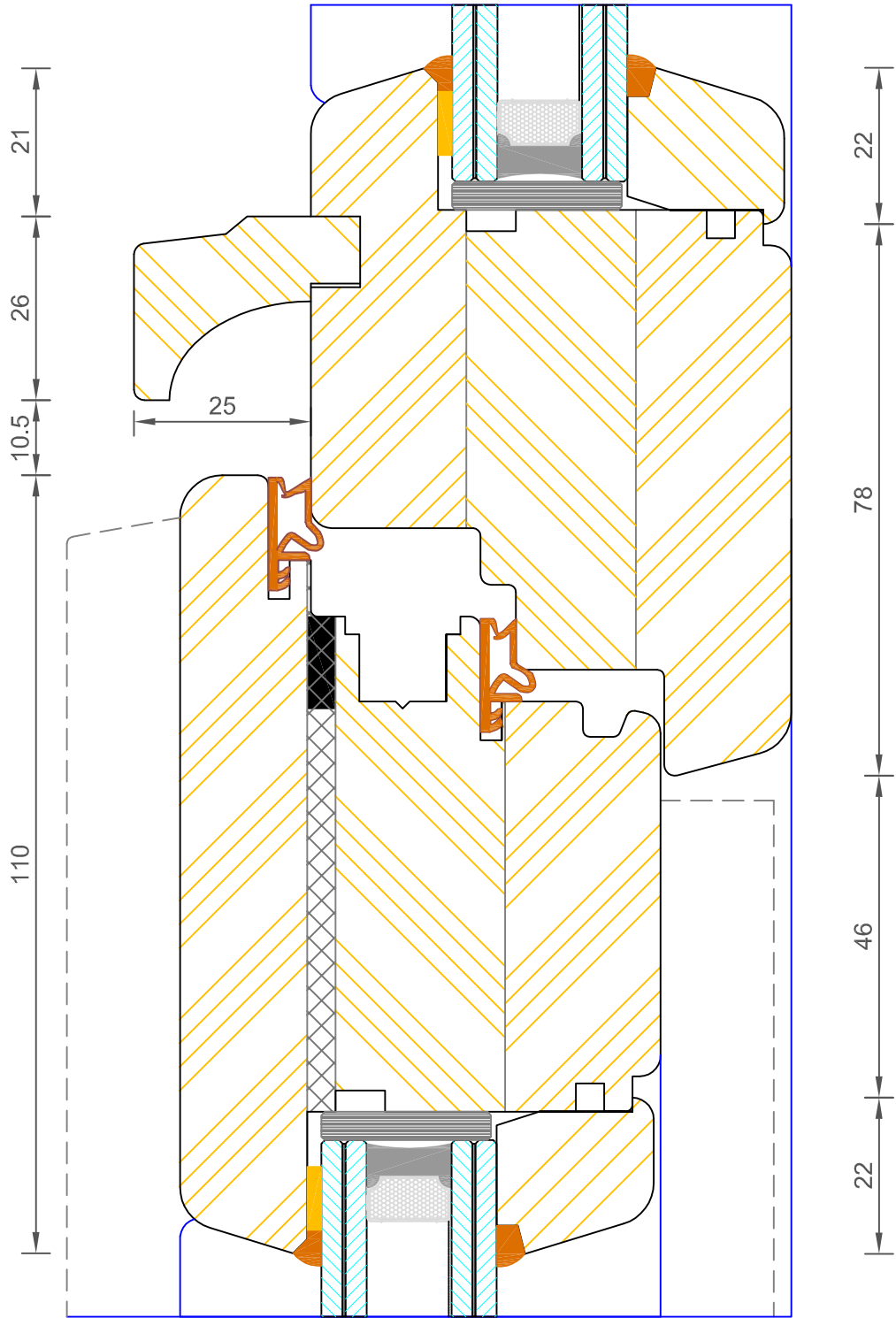

**Contemporary Open Out Lipped French Door  
Fanlight Transom (Leaf Without Vent)**

DIMENSIONS	PLOT SIZE	SCALE	DATE	REV	DWG NO.
MM	A4	1:1	07.02.2011	A	<b>1217</b>
Please consider the environment before printing					



# Bereco

## Contemporary Open Out Lipped French Door Flying Mullion (Single Handle)

DIMENSIONS		PLOT SIZE	SCALE	DATE	REV	DWG. NO.
MM	A1	A1	1:1	07.02.2011	A	<b>1219</b>

Please consider the environment before printing

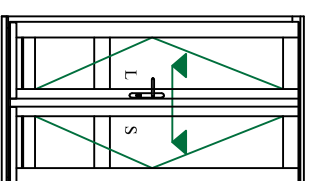
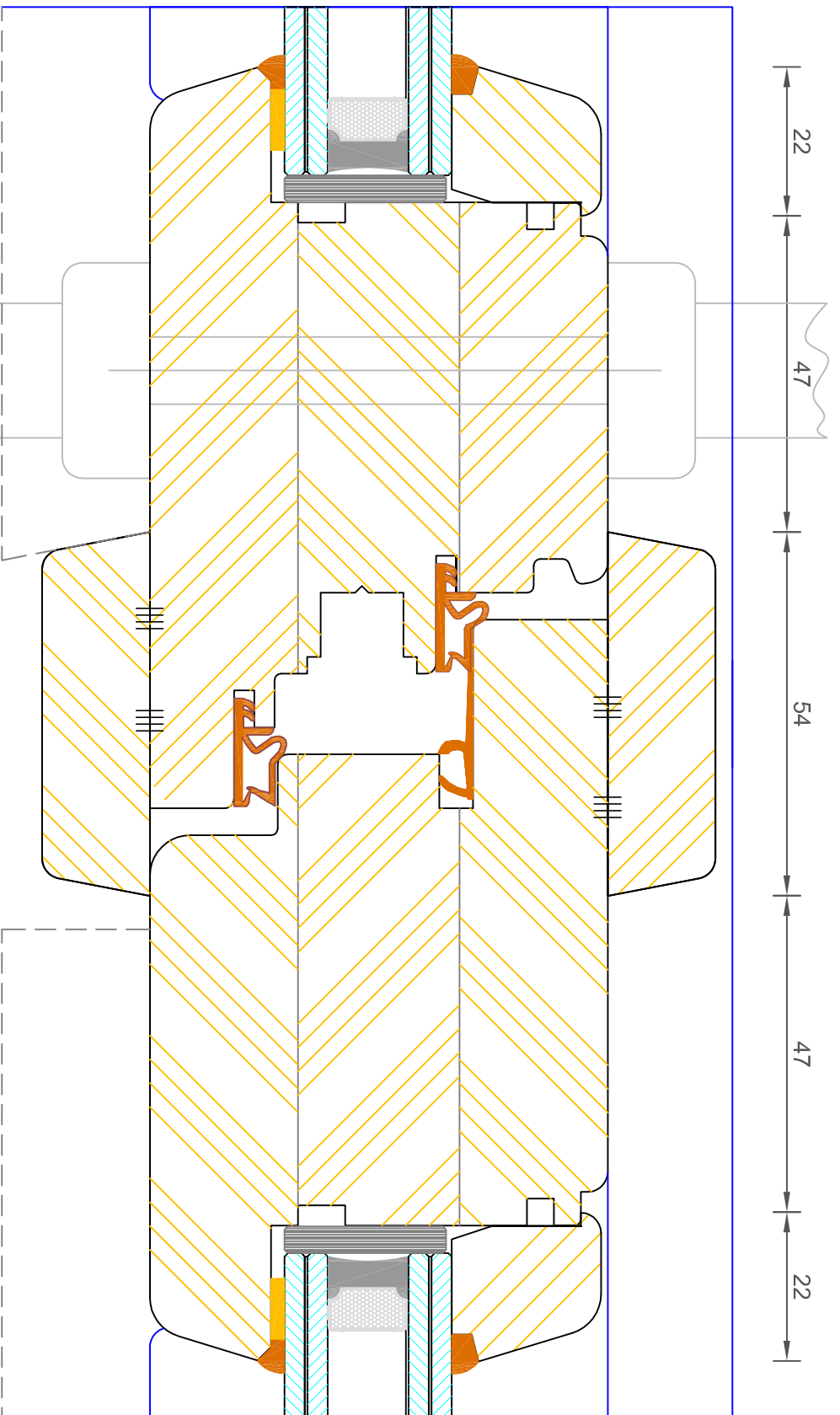



# Bereco

## Contemporary Open Out Lipped French Door Solid Mullion

DIMENSIONS	PLOT SIZE	SCALE	DATE	REV	DWG. NO.
MM	A1	1:1	07.02.2011	A	1220

Please consider the environment before printing

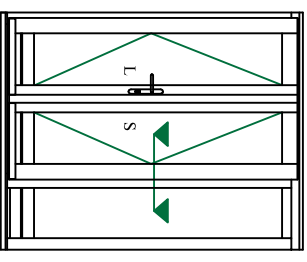
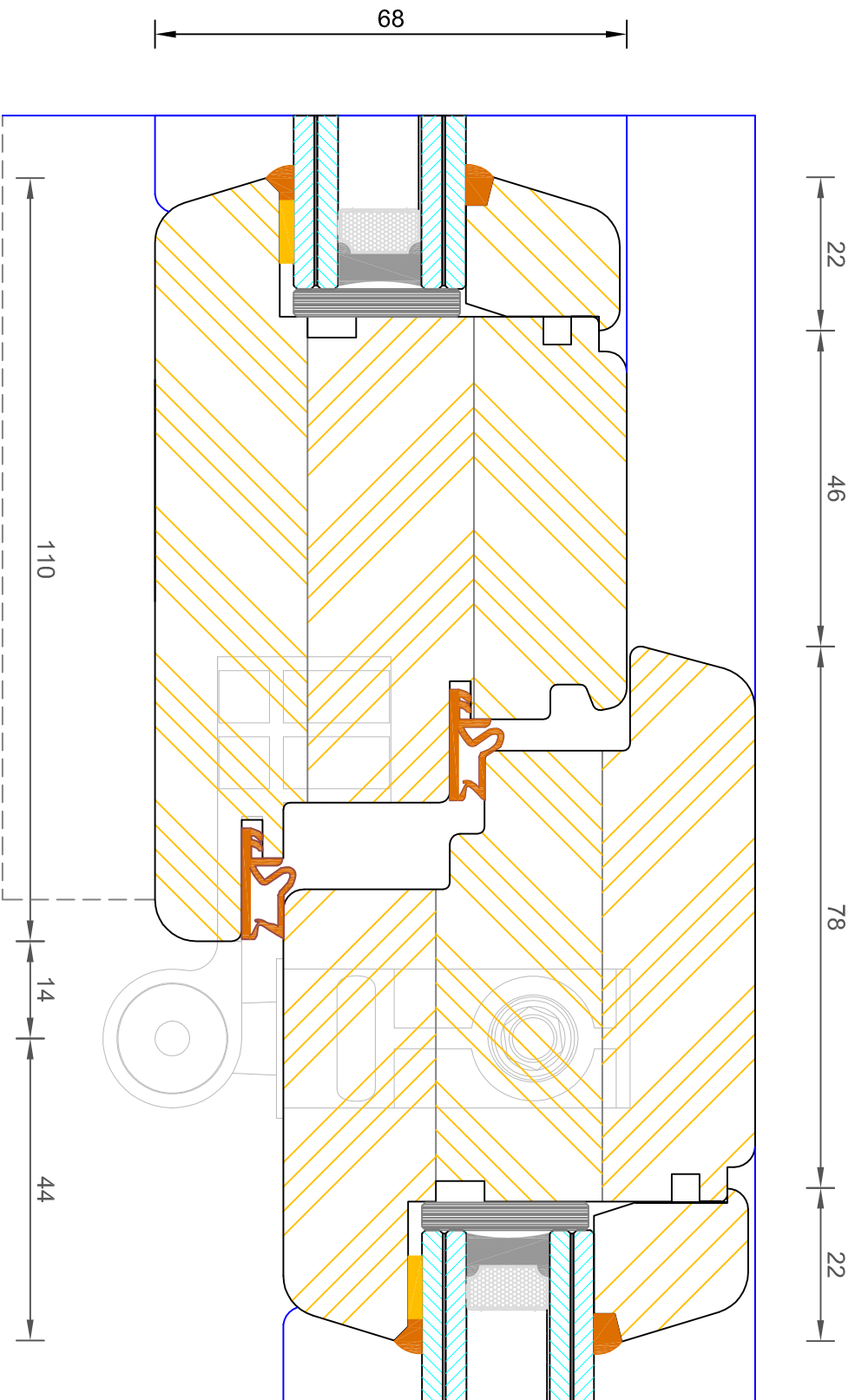

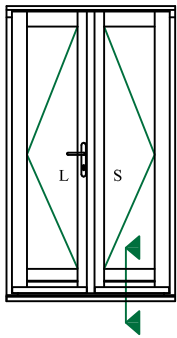
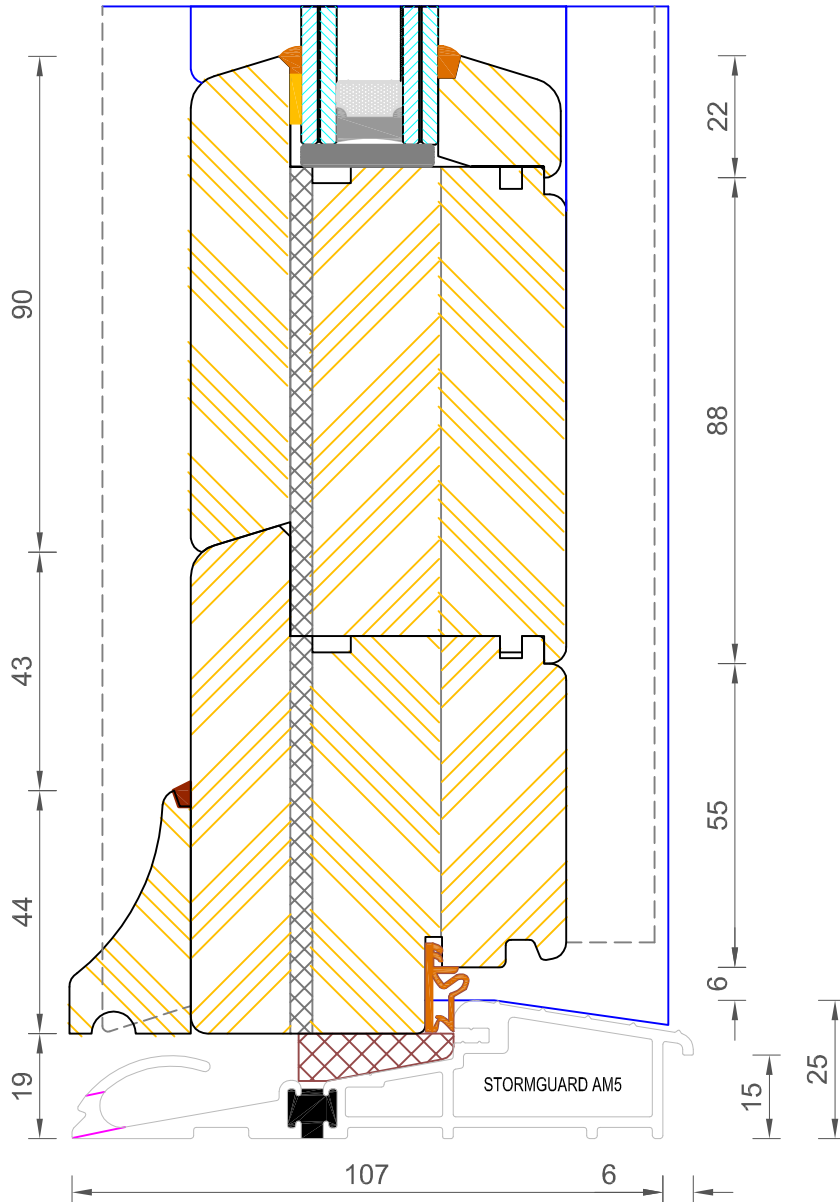

**Contemporary Open Out Lipped French Door  
Mobility Threshold**

DIMENSIONS	PLOT SIZE	SCALE	DATE	REV	DWG NO.
MM	A3	1:1	07.02.2011	A	<b>1214</b>
Please consider the environment before printing					



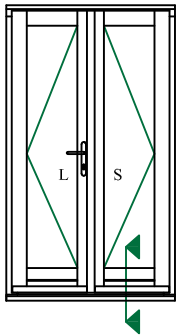
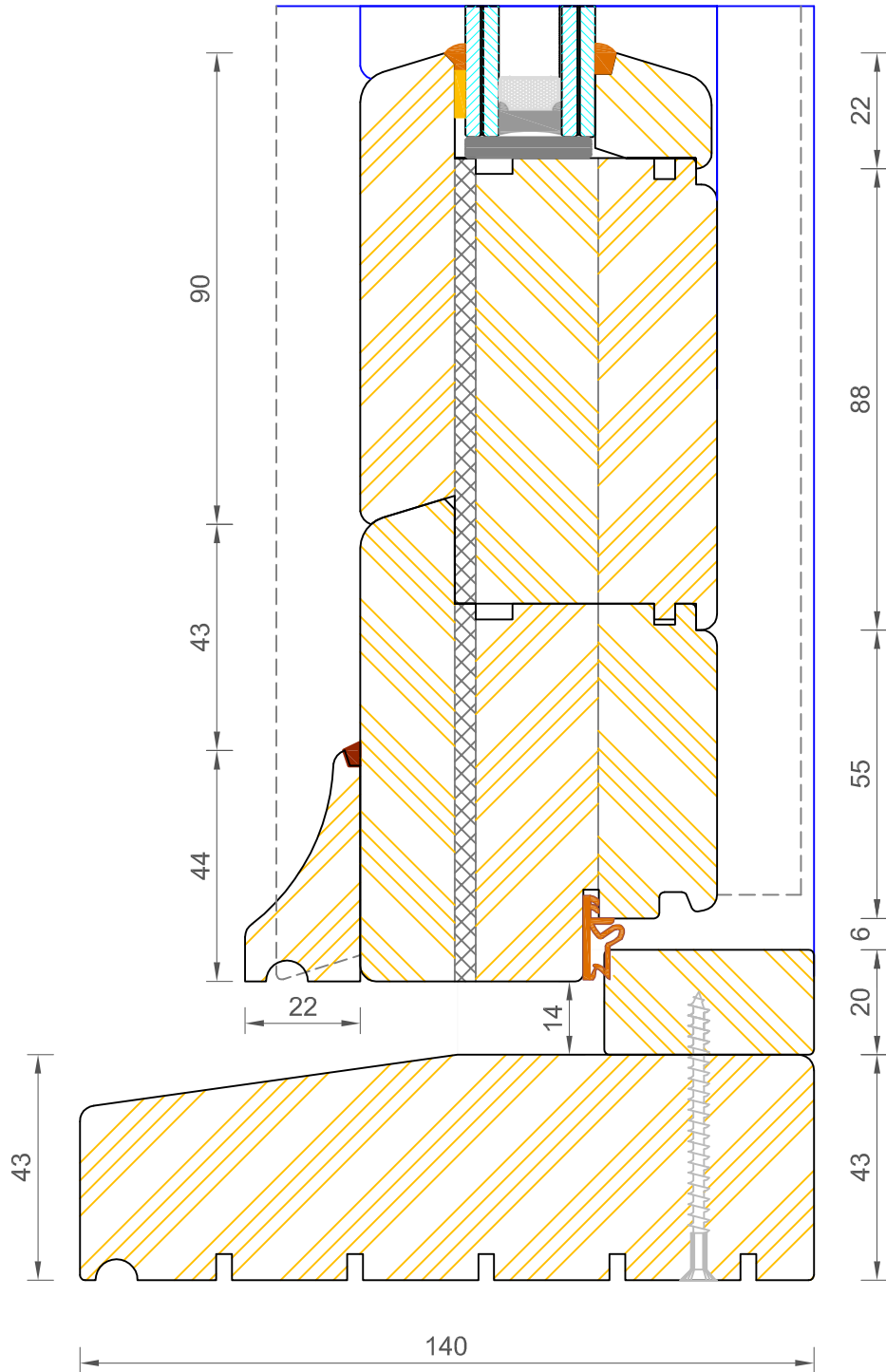

**Contemporary Open Out Lipped French Door  
Standard Thresh**

DIMENSIONS	PLOT SIZE	SCALE	DATE	REV	DWG NO.
MM	A3	1:1	07.02.2011	A	<b>1212</b>

Please consider the environment before printing

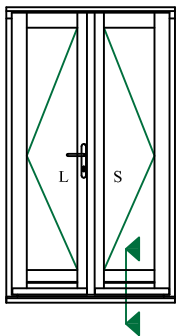
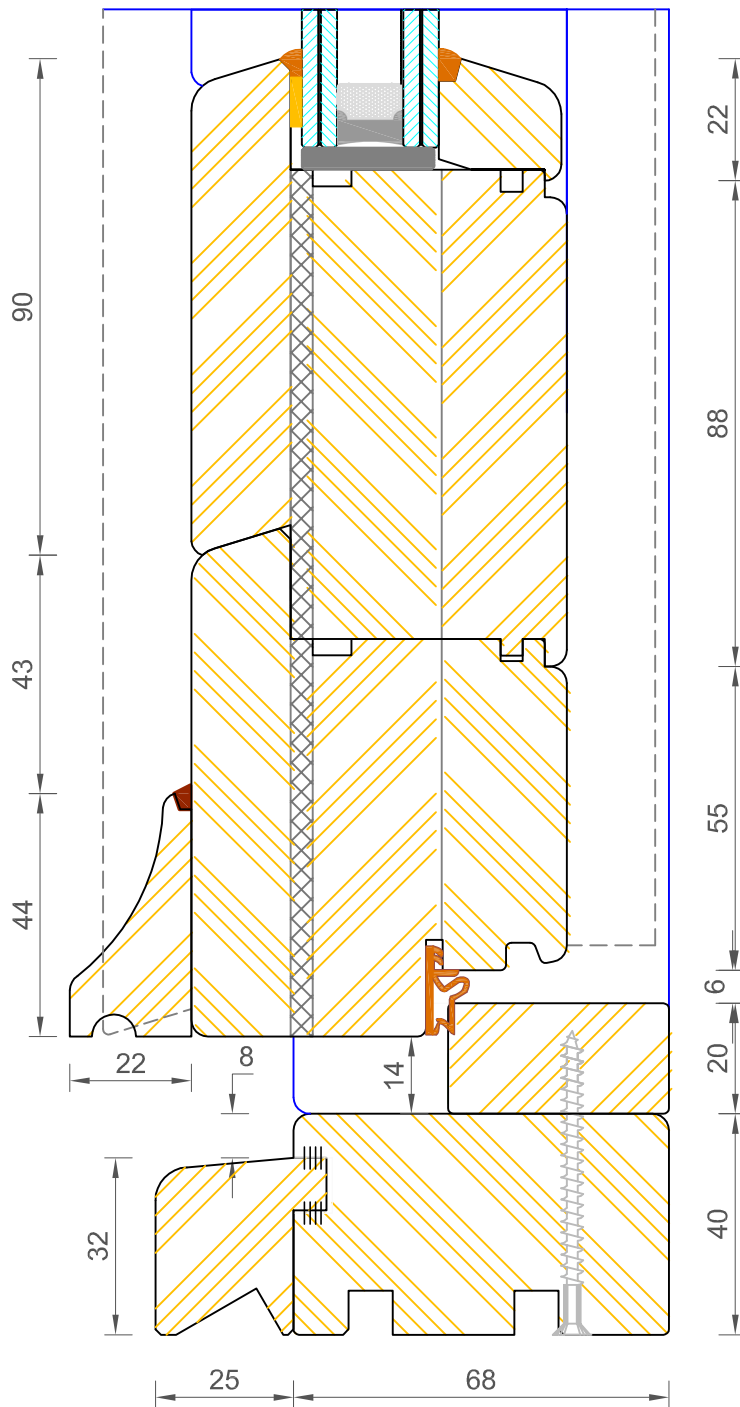

**CILL EXTENSION** - available options: 25mm (93mm o/a) / 47mm (115mm o/a) / 62mm (129mm o/a) / 87mm (155mm o/a) / 114mm (182mm o/a) / 125mm (193mm o/a) / 140mm (208mm o/a)

**NOTE:** Cill Extensions should be supported from underneath; the maximum overhang over Brick / Blockwork for cill extension should not exceed 25mm In order to avoid damage when stepped on. Warranties are Invalidated when fitted with overhang Out excess to that.

If not otherwise stated, Hardwood Threshold will be painted the same colour as Frame.



### Contemporary Open Out Lipped French Door Coupling Thresh

DIMENSIONS	PLOT SIZE	SCALE	DATE	REV	DWG NO.
MM	A3	1:1	07.02.2011	A	<b>1213</b>
 Please consider the environment before printing					

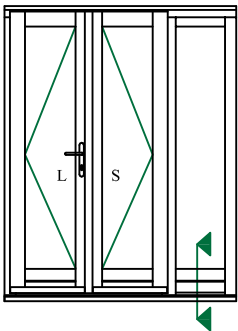
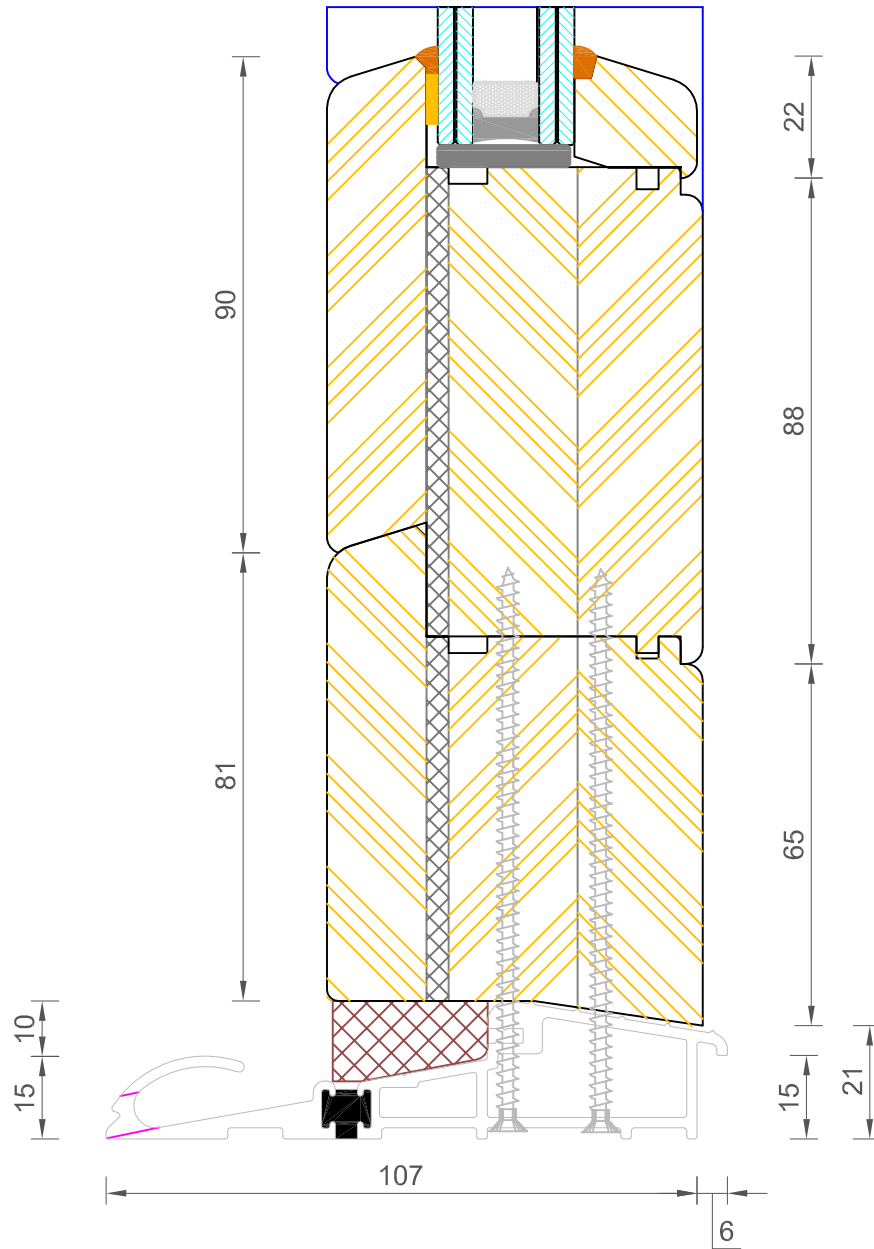

**Contemporary Open Out Lipped French Door  
Mobility Threshold (Sidelight)**

DIMENSIONS	PLOT SIZE	SCALE	DATE	REV	DWG NO.
MM	A3	1:1	07.02.2011	A	<b>1208</b>

Please consider the environment before printing

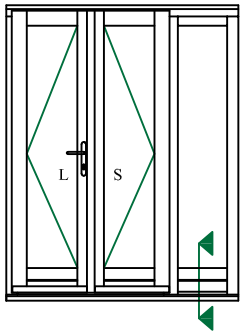
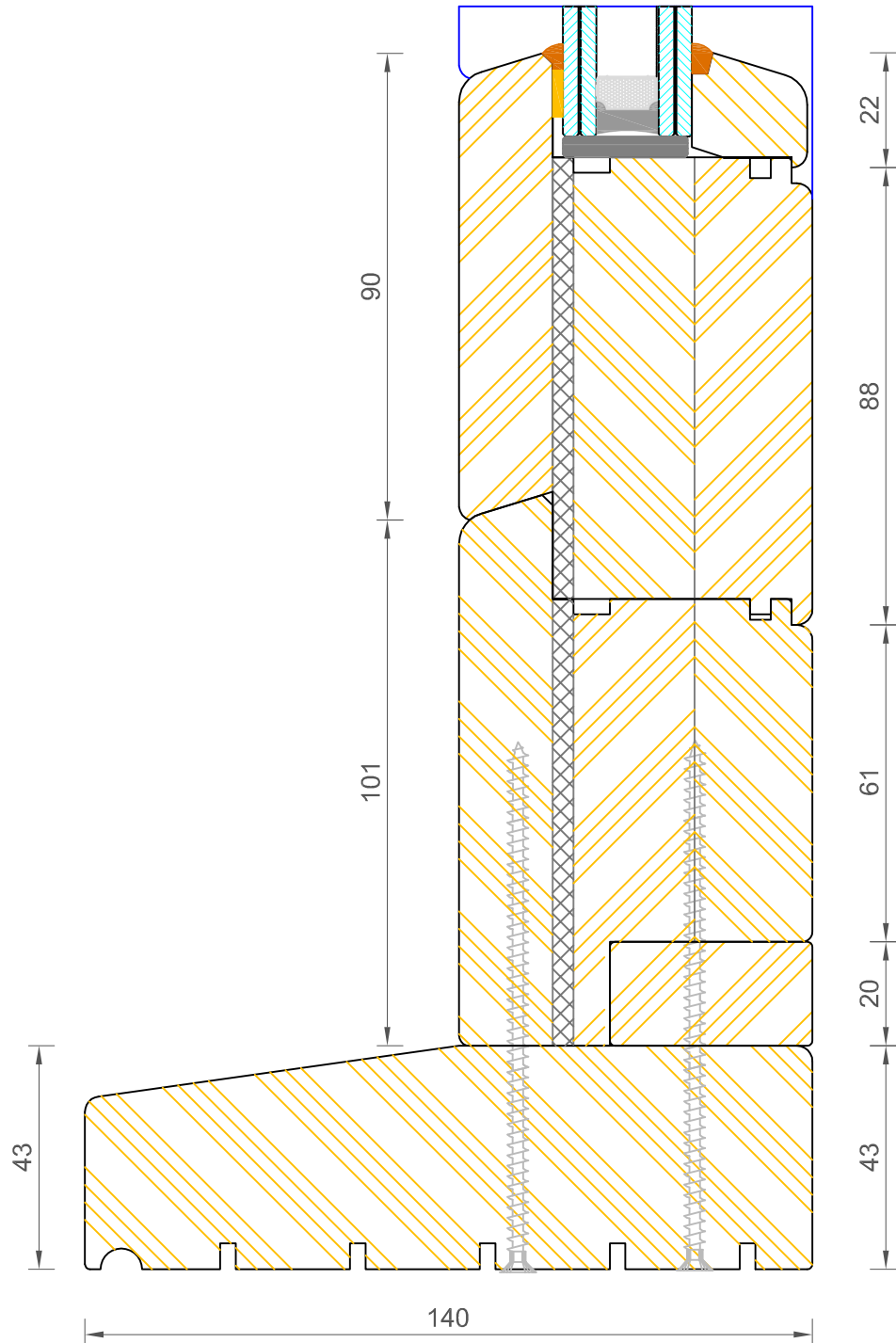

### Contemporary Open Out Lipped French Door Standard Thresh (Sidelight)

DIMENSIONS	PLOT SIZE	SCALE	DATE	REV	DWG NO.
MM	A3	1:1	07.02.2011	A	<b>1206</b>
 Please consider the environment before printing					

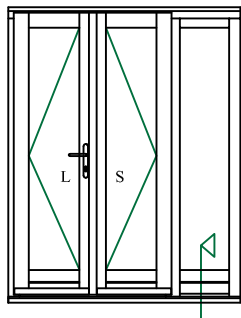
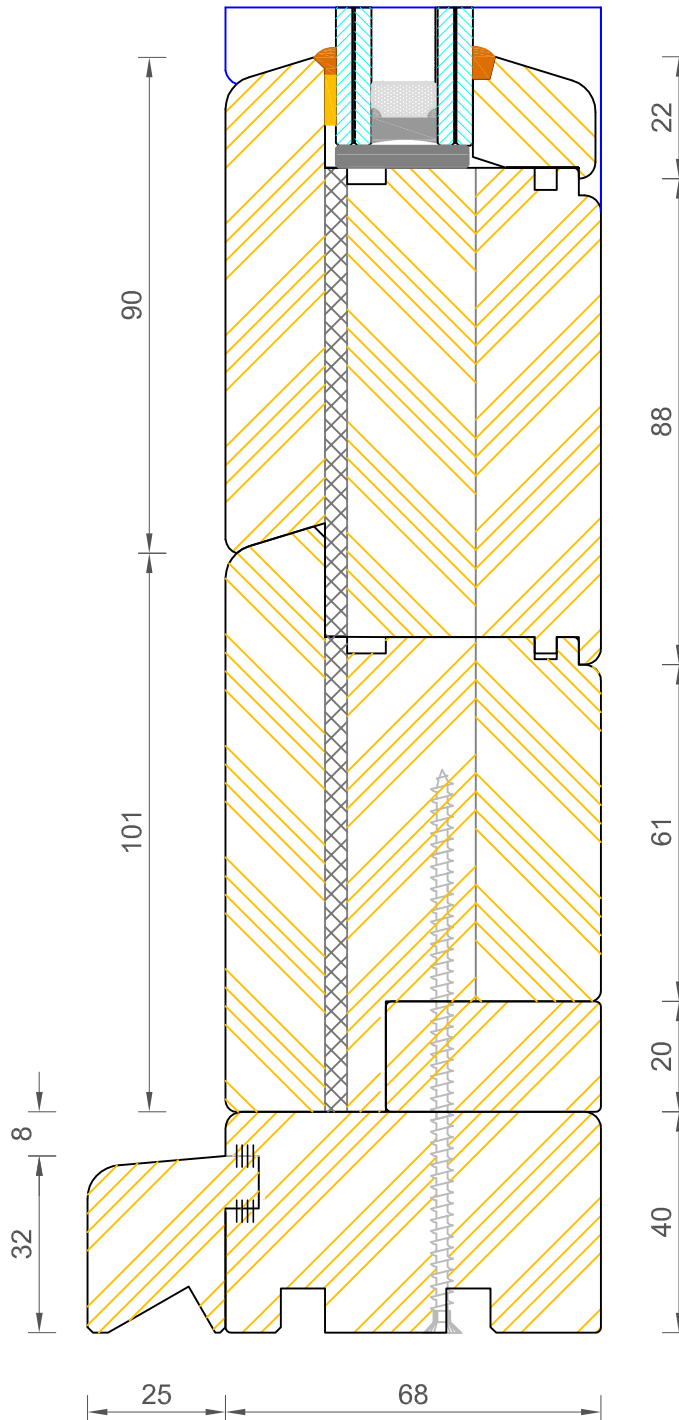

**CILL EXTENSION** - available options: 25mm (93mm o/a) / 47mm (115mm o/a) / 62mm (129mm o/a) / 87mm (155mm o/a) / 114mm (182mm o/a) / 125mm (193mm o/a) / 140mm (208mm o/a)

**NOTE:** Cill Extensions should be supported from underneath; the maximum overhang over Brick / Blockwork for cill extension should not exceed 25mm In order to avoid damage when stepped on. Warranties are Invalidated when fitted with overhang Out excess to that.

If not otherwise stated, Hardwood Threshold will be painted the same colour as Frame.

DIMENSIONS	PLOT SIZE	SCALE	DATE	REV	DWG NO.
MM	A3	1:1	07.02.2011	A	<b>1207</b>