

**Contemporary Open Out Lipped French Door**  
Triple Glazed - Cill Extension Options

DIMENSIONS	PLOT SIZE	SCALE	DATE	REV	DWG NO.
MM	A4	1:1	25.09.2019	B	<b>1265</b>

Please consider the environment before printing

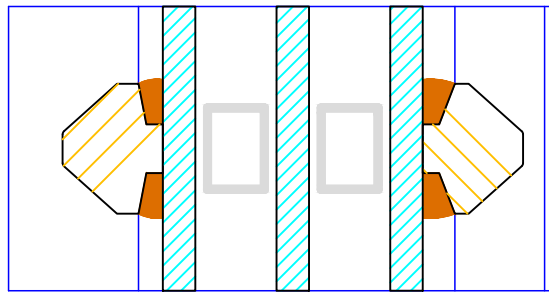

16

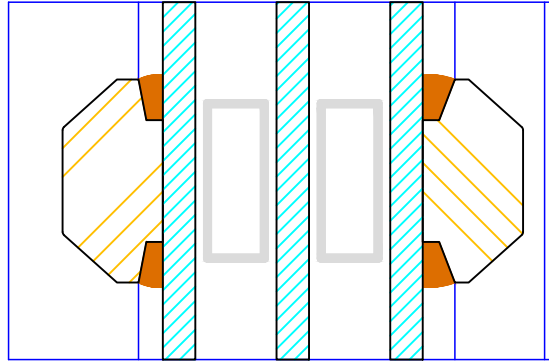

25

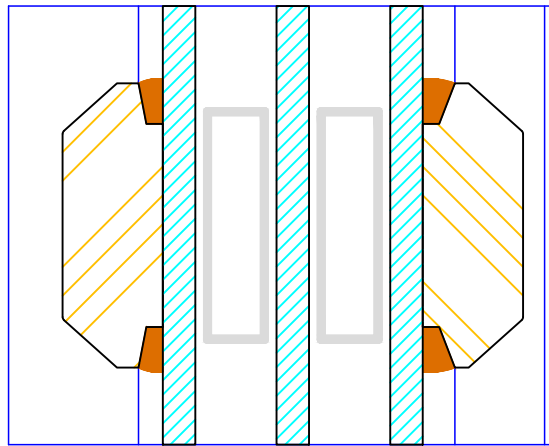

35

60 (varies min 60 / max 110mm)

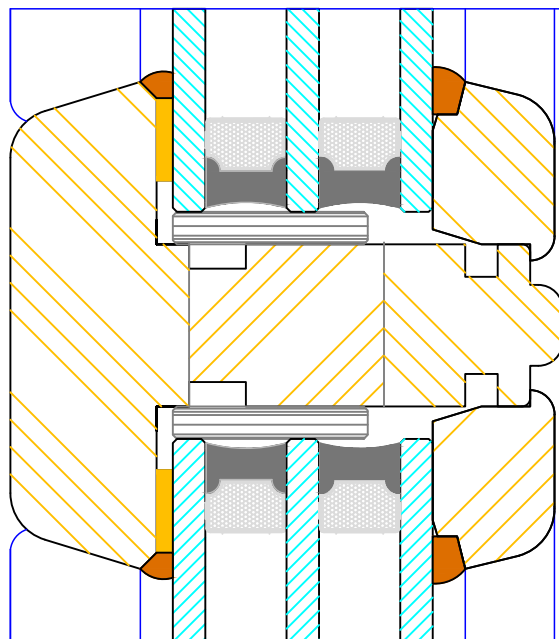

22  
16  
22

68

DIMENSIONS	PLOT SIZE	SCALE	DATE	REV	DWG NO.
MM	A4	1:1	06.05.2014	A	<b>1247</b>
Please consider the environment before printing					

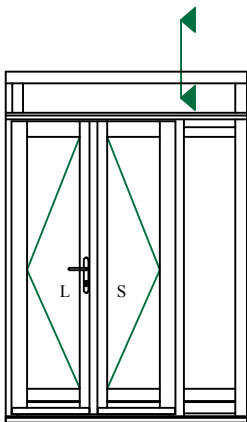
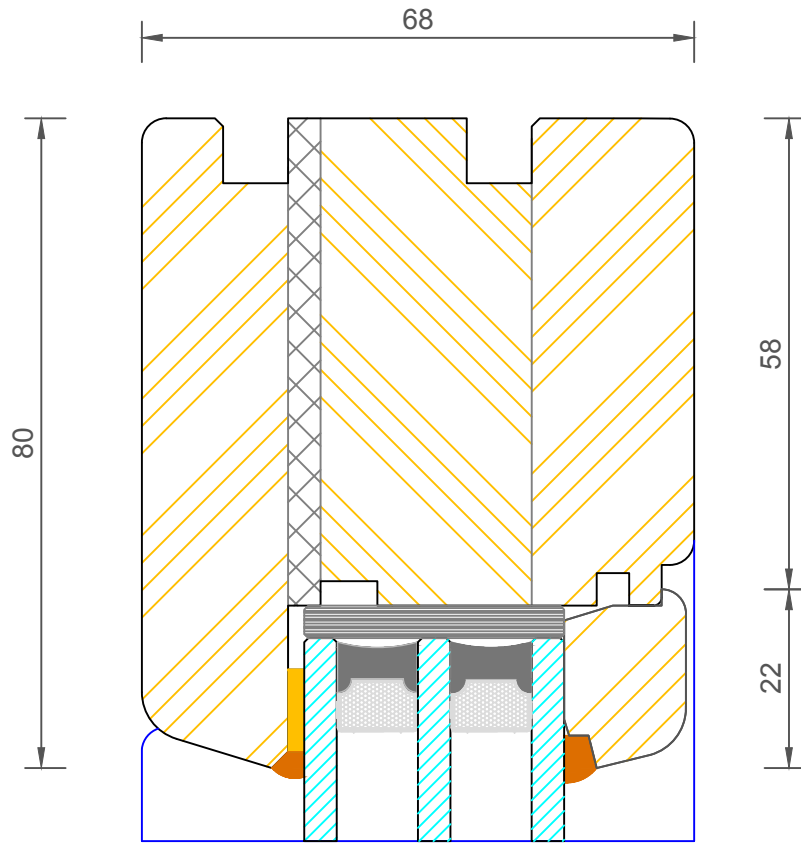

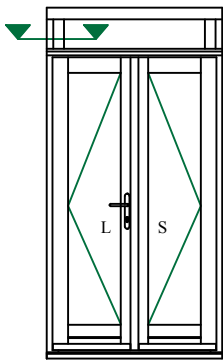
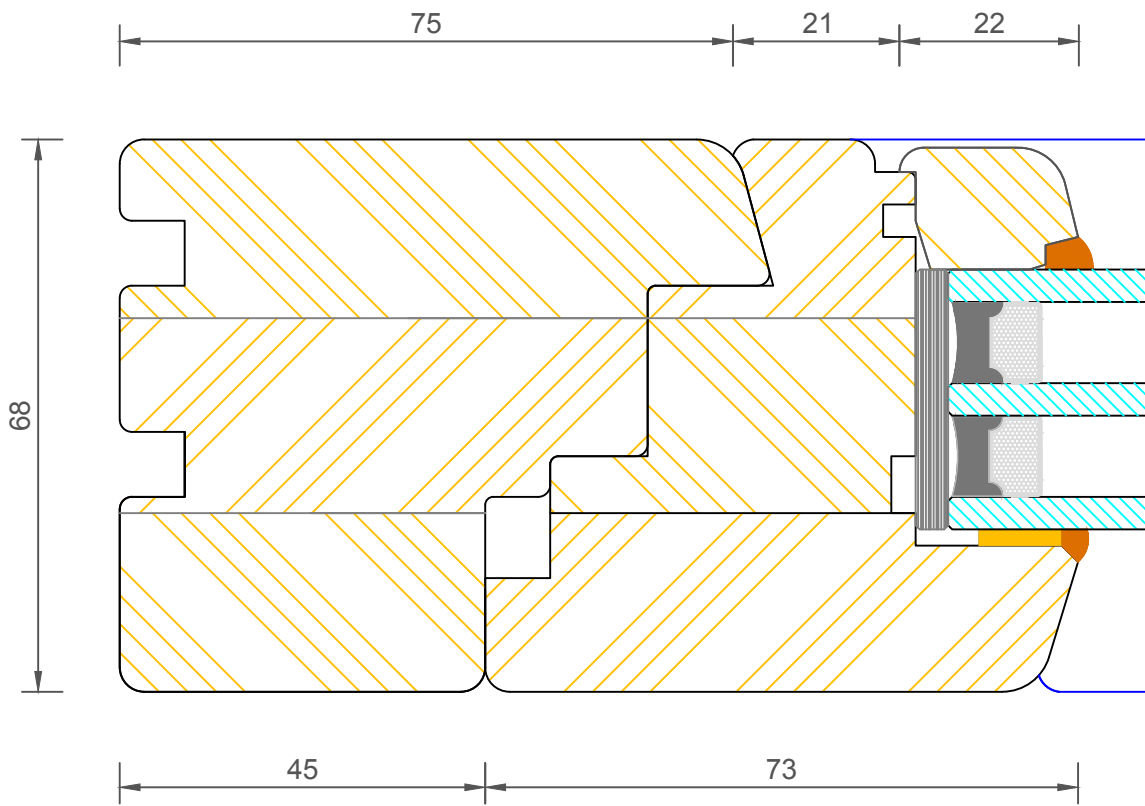

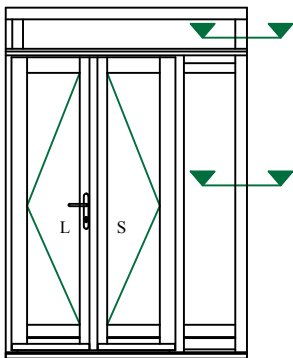
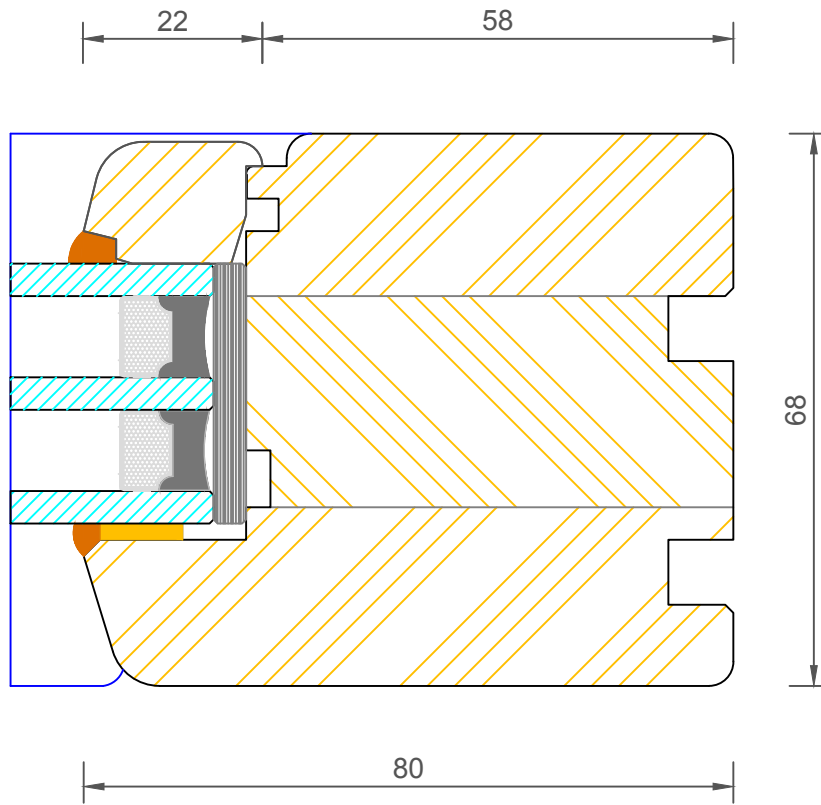

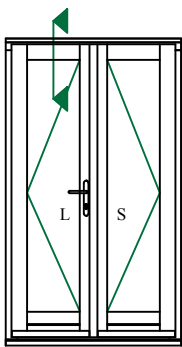
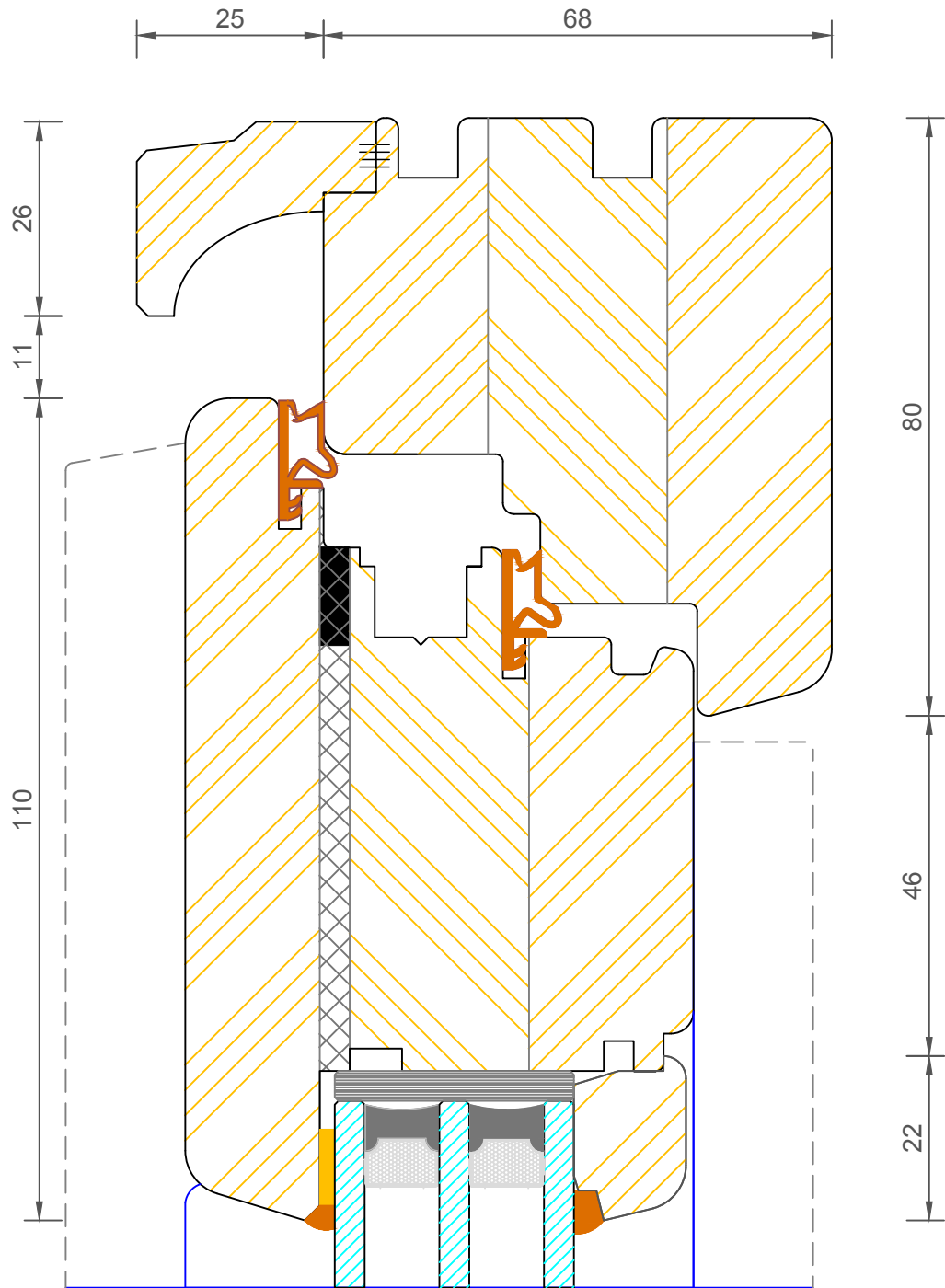

**Contemporary Open Out Lipped French Door**  
 Triple Glazed - Frame & Leaf Head (Without Vent)

DIMENSIONS	PLOT SIZE	SCALE	DATE	REV	DWG NO.
MM	A4	1:1	06.05.2014	A	<b>1251</b>

Please consider the environment before printing

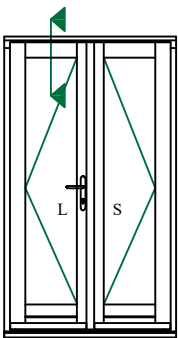
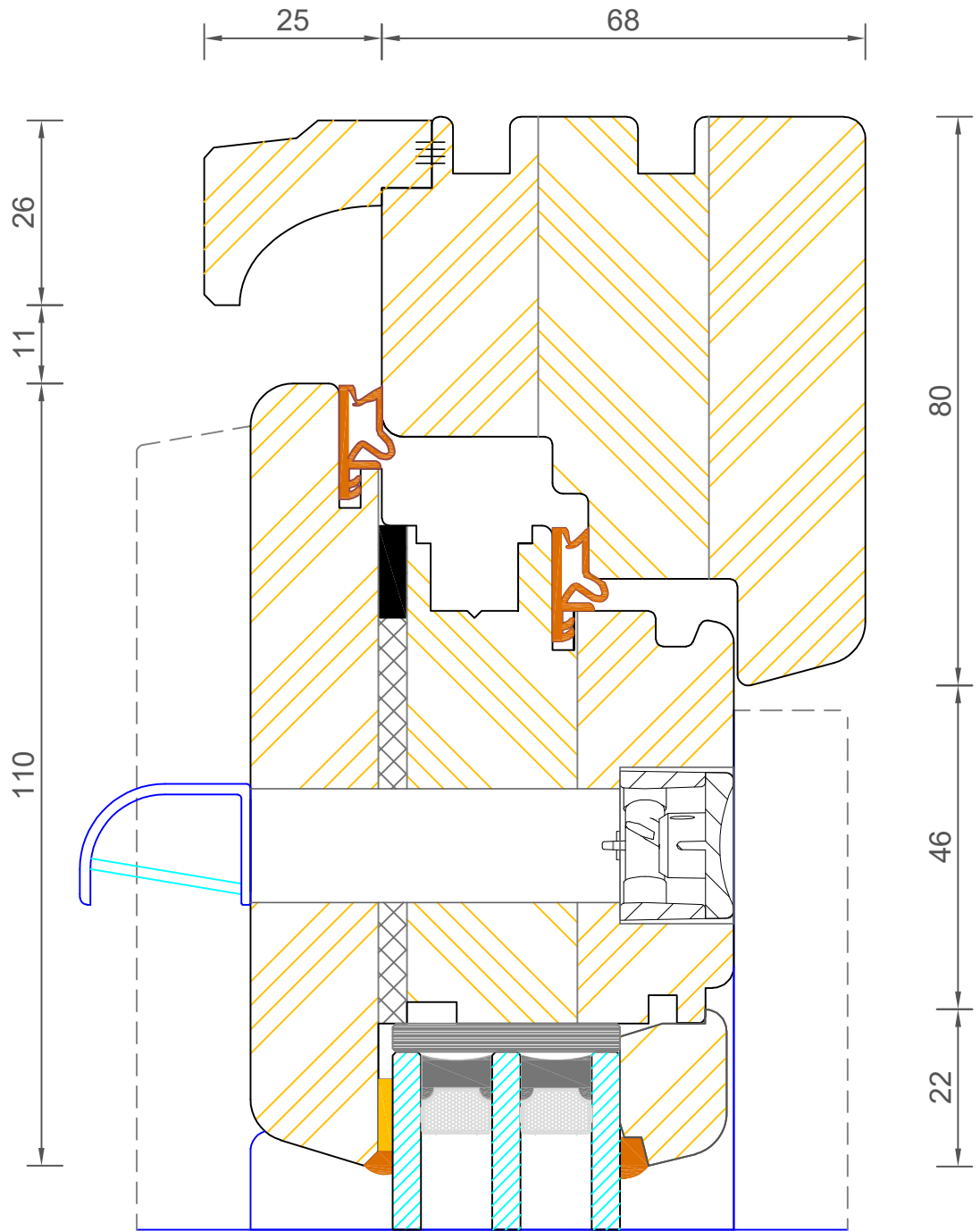

**Contemporary Open Out Lipped French Door**  
 Triple Glazed - Frame & Leaf (With Vent in Top Rail)

DIMENSIONS	PLOT SIZE	SCALE	DATE	REV	DWG NO.
MM	A4	1:1	04.07.2022	B	<b>1252</b>
Please consider the environment before printing					

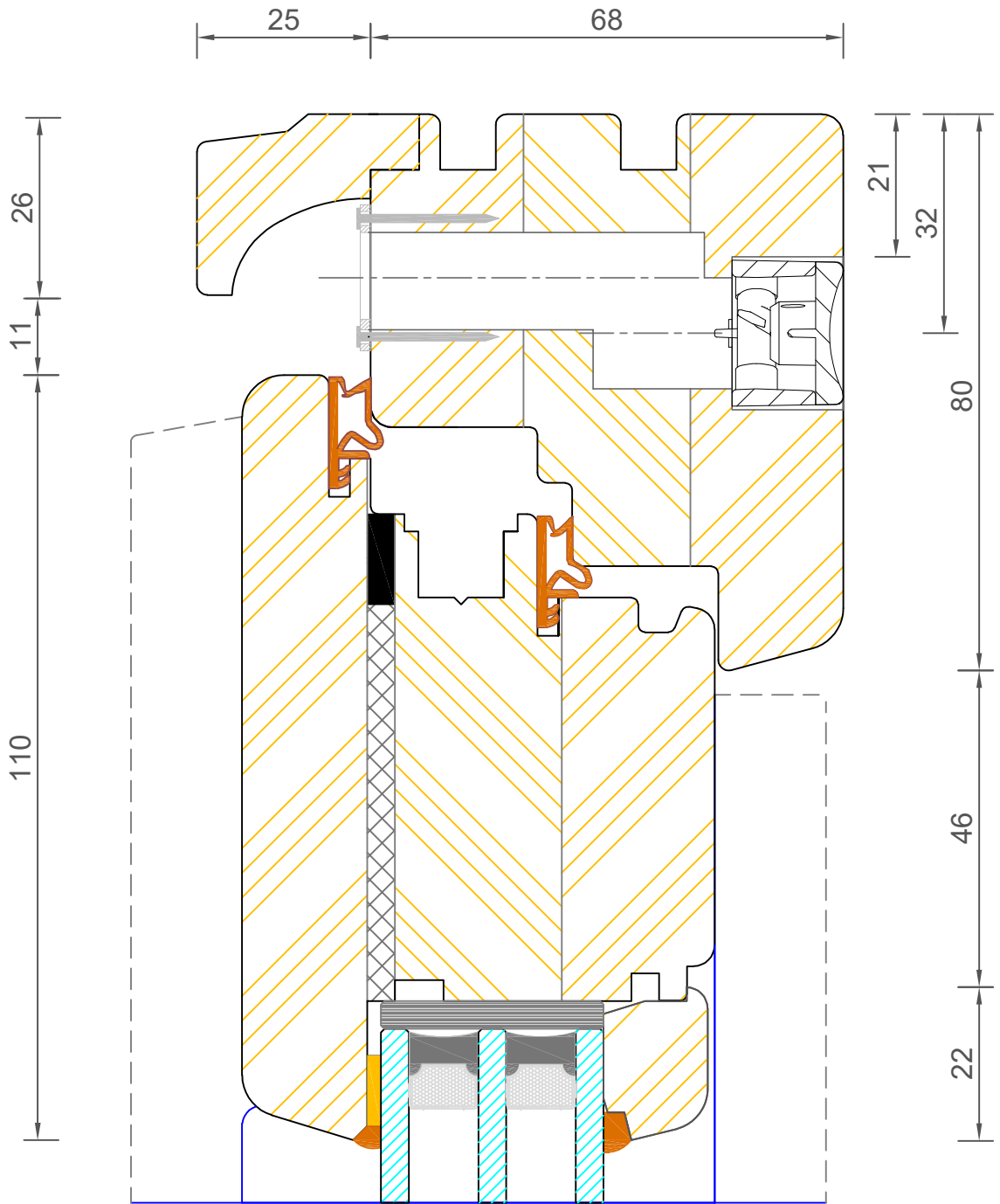
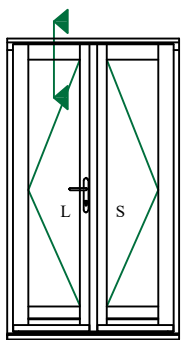

**Contemporary Open Out Lipped French Door**  
 Triple Glazed - Frame & Leaf (With Vent in Frame Head)

DIMENSIONS	PLOT SIZE	SCALE	DATE	REV	DWG NO.
MM	A4	1:1	04.07.2022	B	<b>1252.1</b>
Please consider the environment before printing					



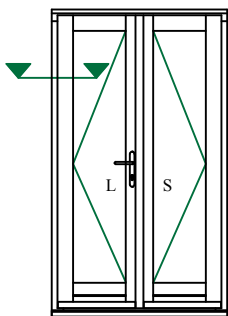
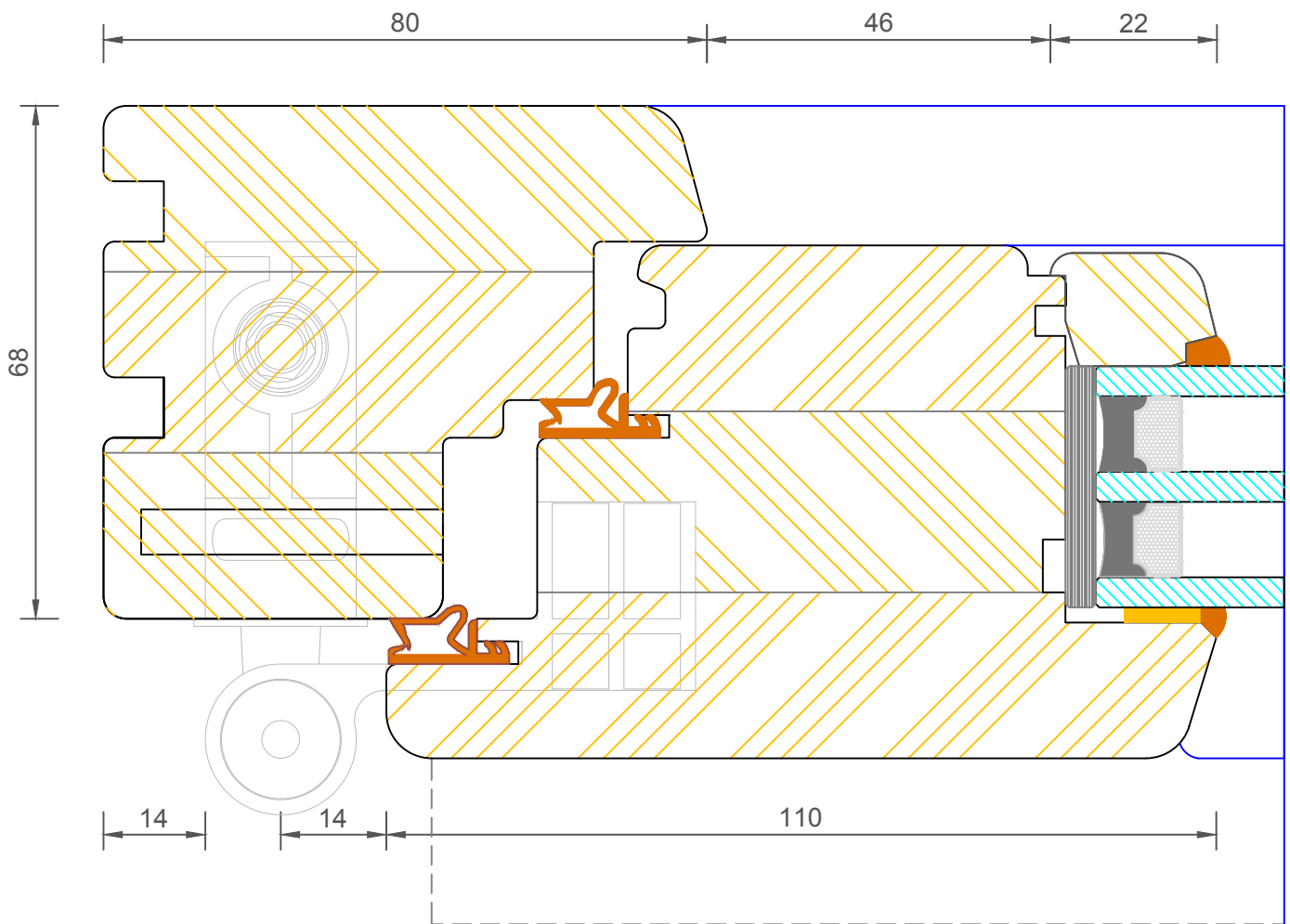

**Contemporary Open Out Lipped French Door**  
 Triple Glazed - Frame & Leaf Jamb (80mm)

DIMENSIONS	PLOT SIZE	SCALE	DATE	REV	DWG NO.
MM	A4	1:1	06.05.2014	A	<b>1253</b>
Please consider the environment before printing					

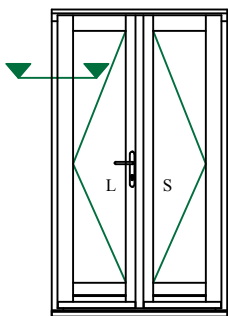
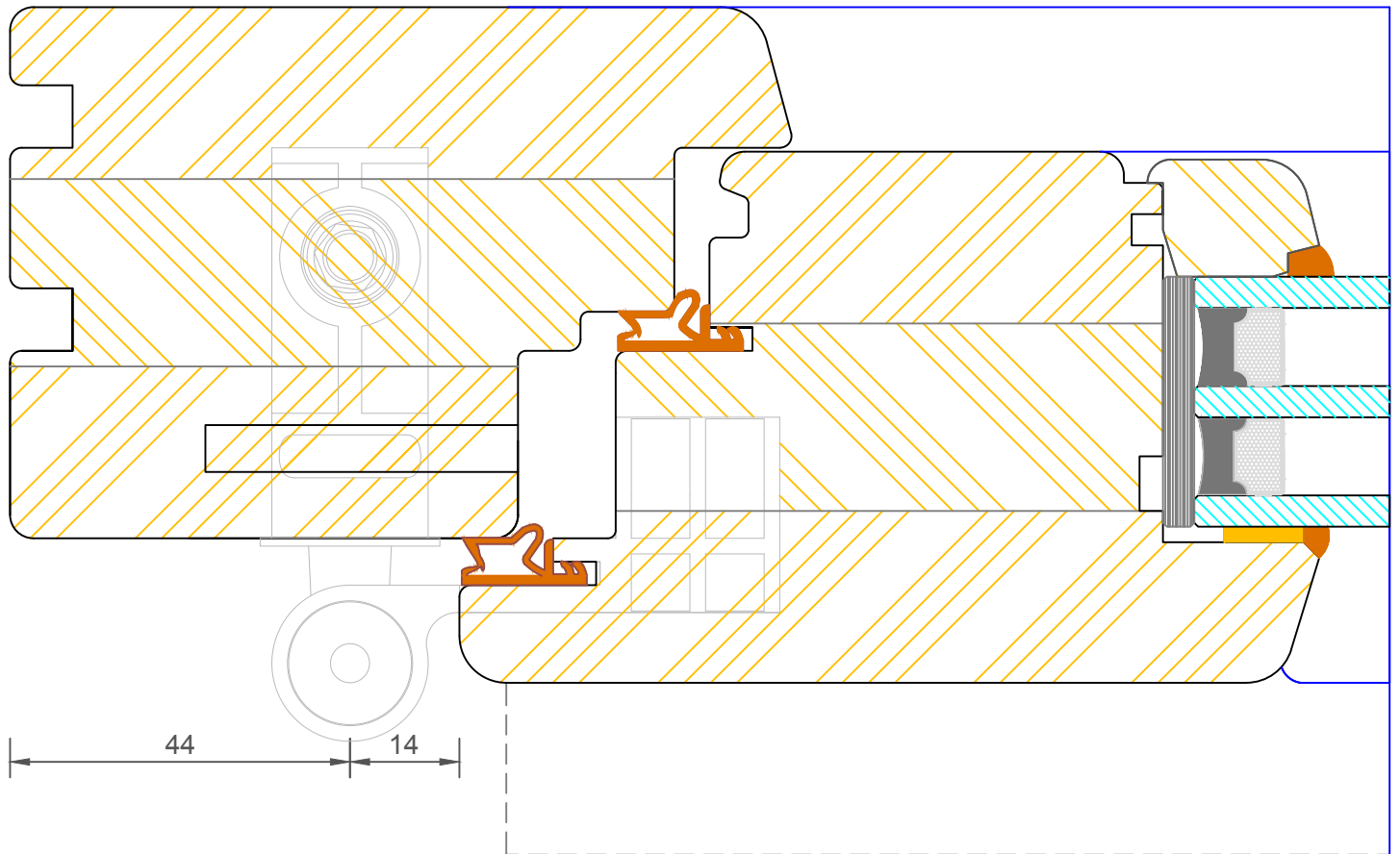

**Contemporary Open Out Lipped French Door**  
**Triple Glazed - Frame & Leaf Jamb (100mm)**

DIMENSIONS	PLOT SIZE	SCALE	DATE	REV	DWG NO.
MM	A4	1:1	06.05.2014	A	<b>1254</b>

Please consider the environment before printing

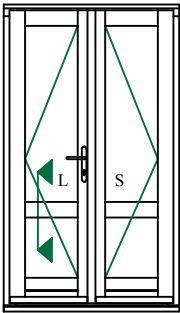
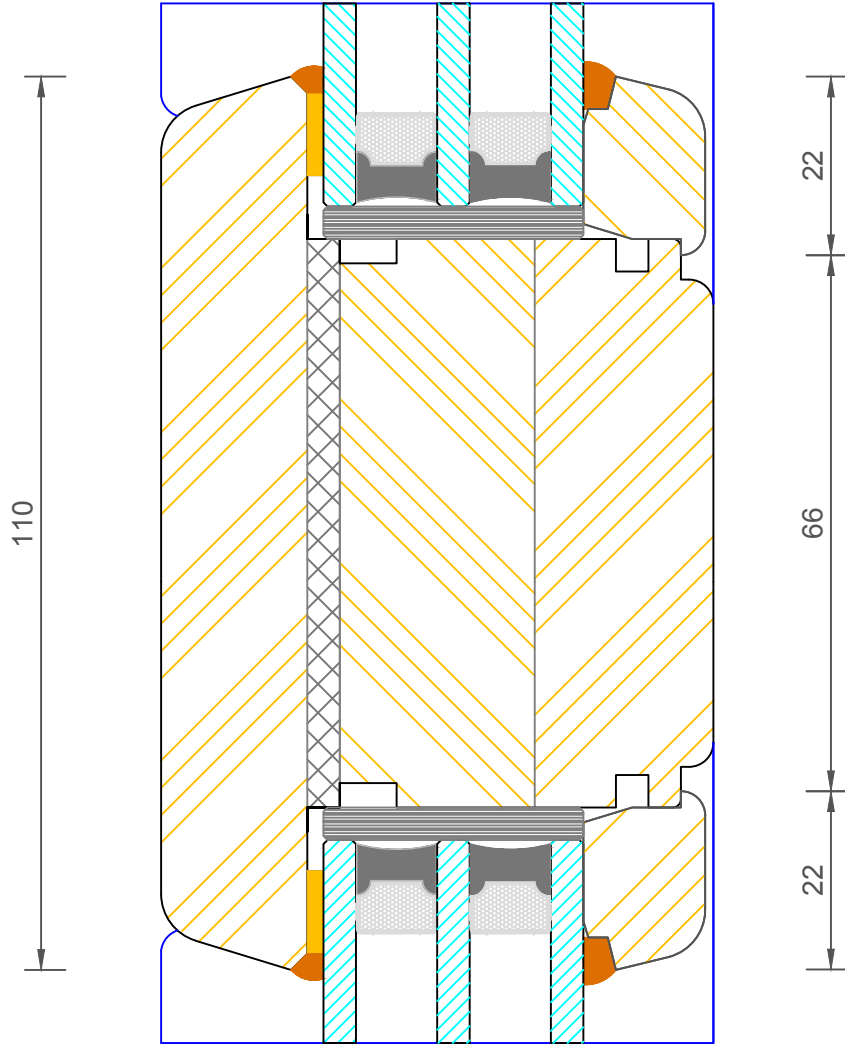

**Contemporary Open Out Lipped French Door  
Triple Glazed - Mid Rail**

DIMENSIONS	PLOT SIZE	SCALE	DATE	REV	DWG NO.
MM	A4	1:1	06.05.2014	A	<b>1255</b>
Please consider the environment before printing					

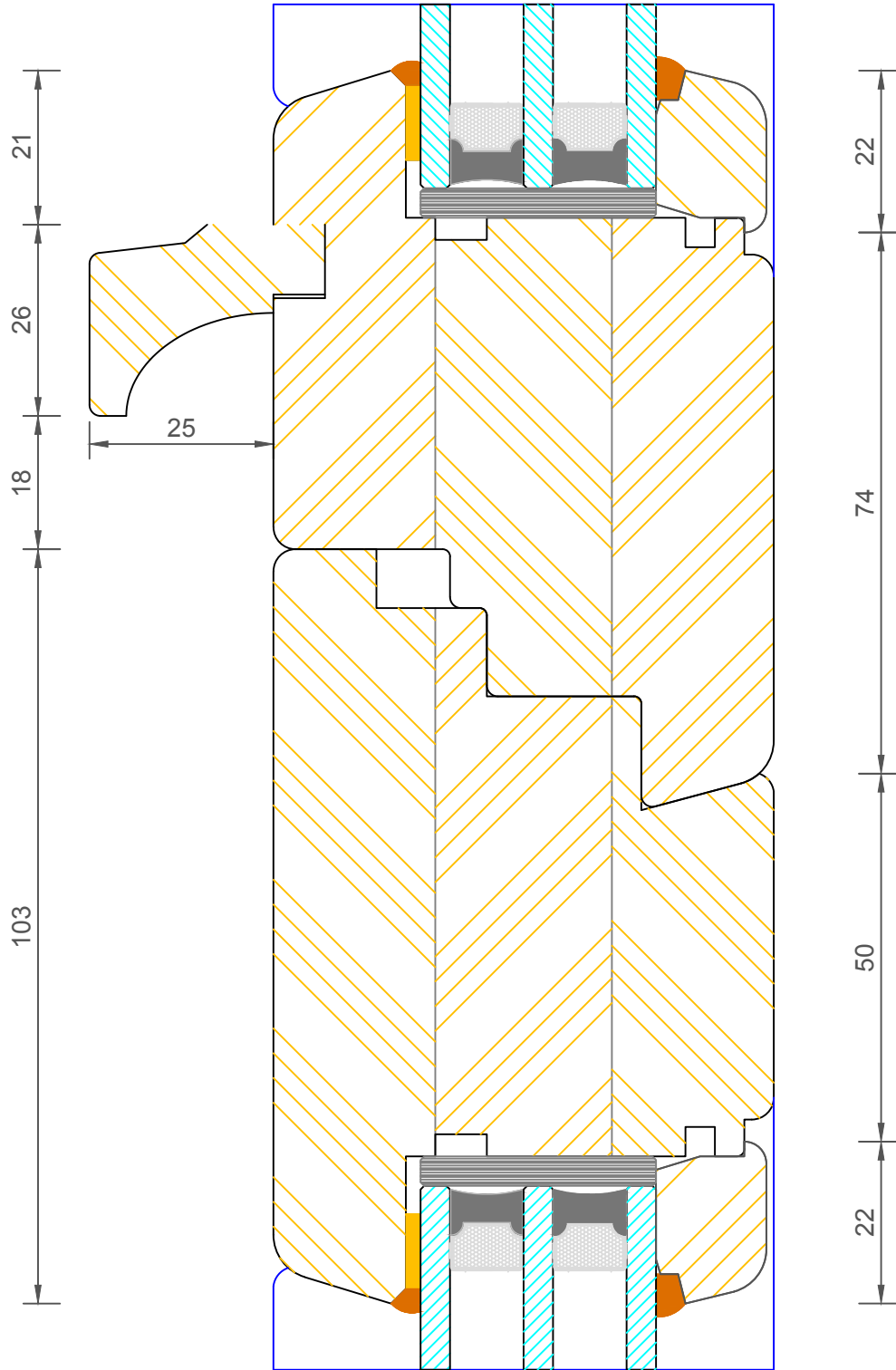
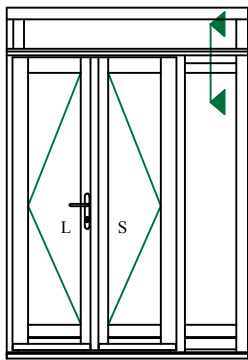

**Contemporary Open Out Lipped French Door**  
 Triple Glazed - Fanlight / Sidelight Transom

DIMENSIONS	PLOT SIZE	SCALE	DATE	REV	DWG NO.
MM	A4	1:1	06.05.2014	A	<b>1256</b>

Please consider the environment before printing

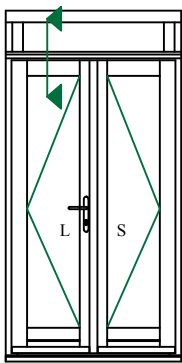
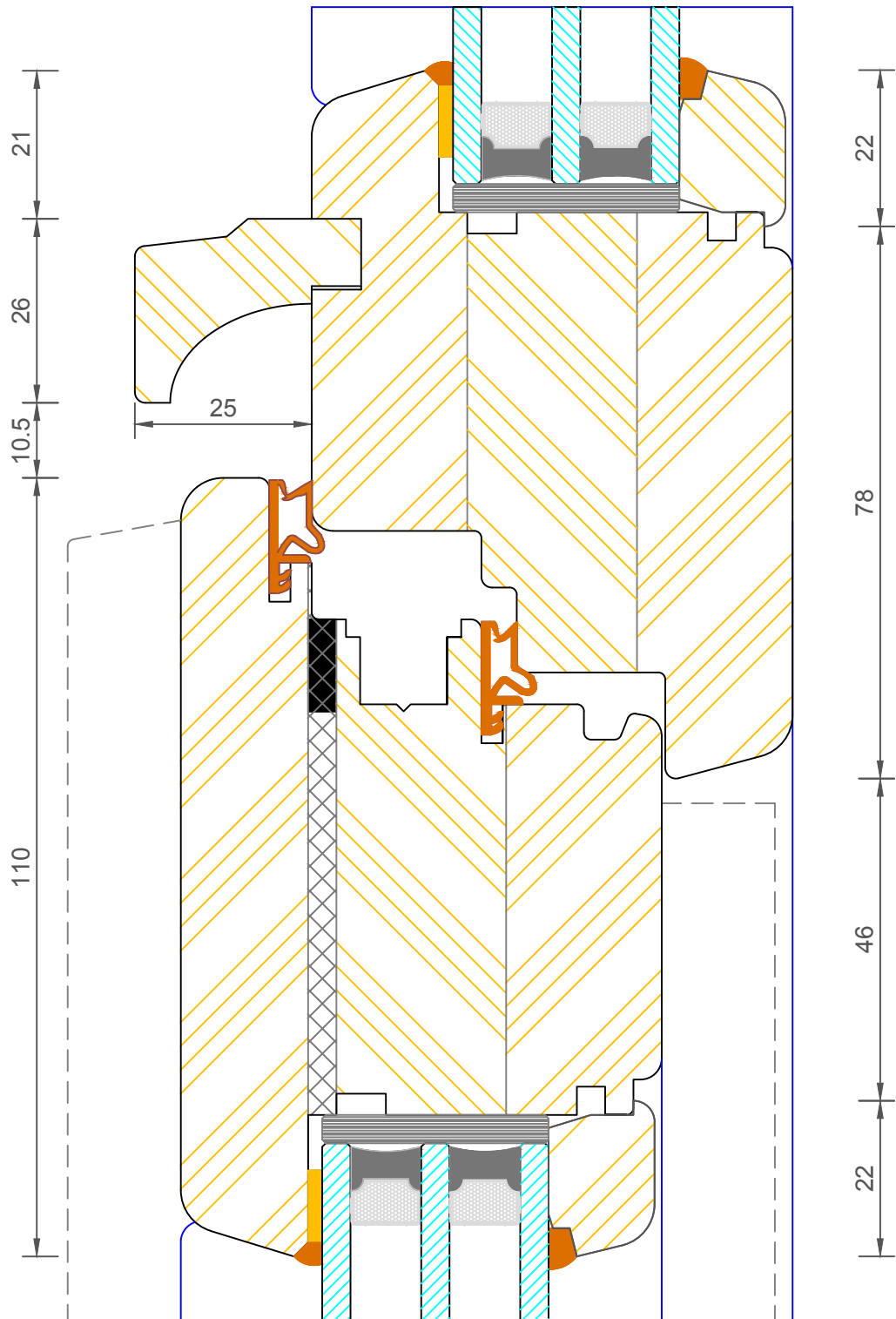

**Contemporary Open Out Lipped French Door**  
**Triple Glazed - Fanlight Transom (Leaf Without Vent)**

DIMENSIONS	PLOT SIZE	SCALE	DATE	REV	DWG NO.
MM	A4	1:1	06.05.2014	A	<b>1257</b>

Please consider the environment before printing

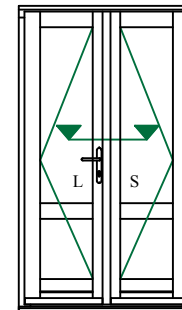
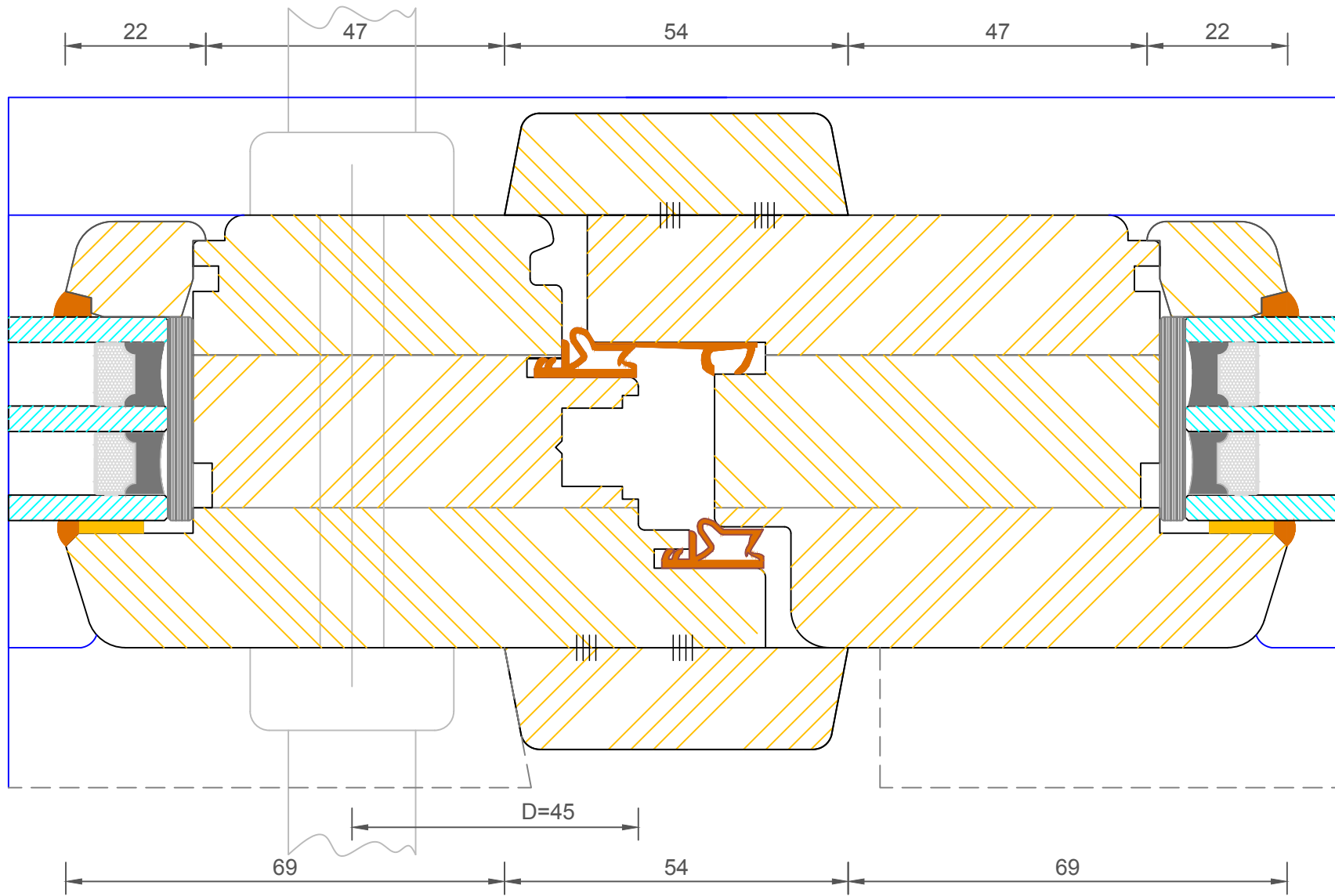

**Contemporary Open Out Lipped French Door**  
**Triple Glazed - Flying Mullion (Single Handle)**

DIMENSIONS	PLOT SIZE	SCALE	DATE	REV	DWG NO.
MM	A4	1:1	06.05.2014	A	<b>1265</b>
Please consider the environment before printing					

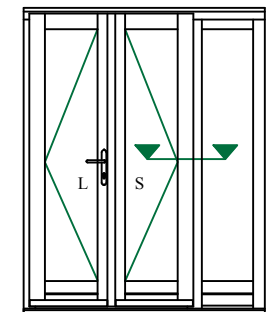
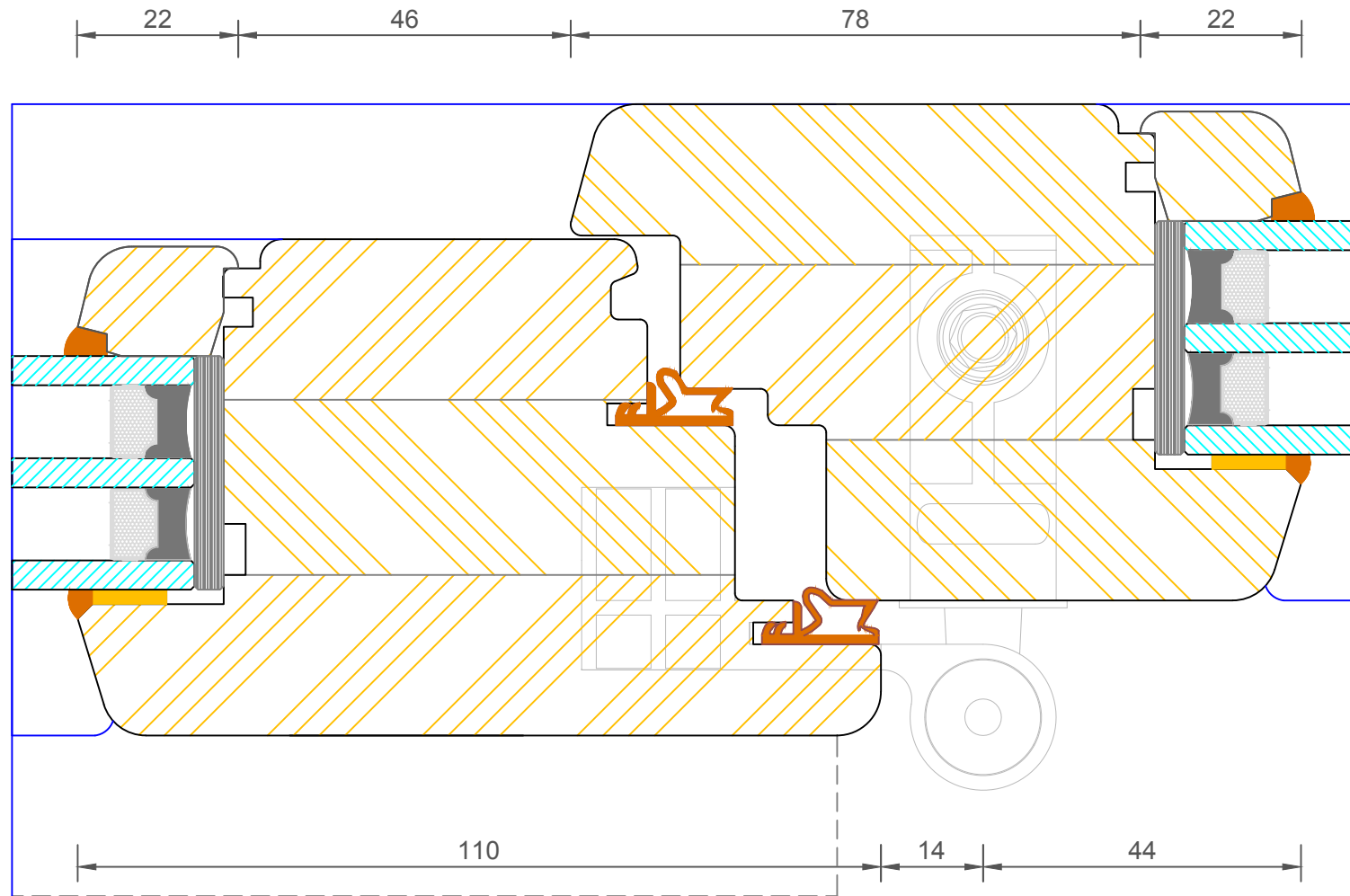

**Contemporary Open Out Lipped French Door**  
**Triple Glazed - Solid Mullion**

DIMENSIONS	PLOT SIZE	SCALE	DATE	REV	DWG NO.
MM	A4	1:1	06.05.2014	A	<b>1266</b>
 Please consider the environment before printing					

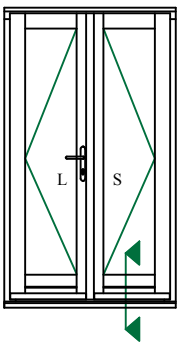
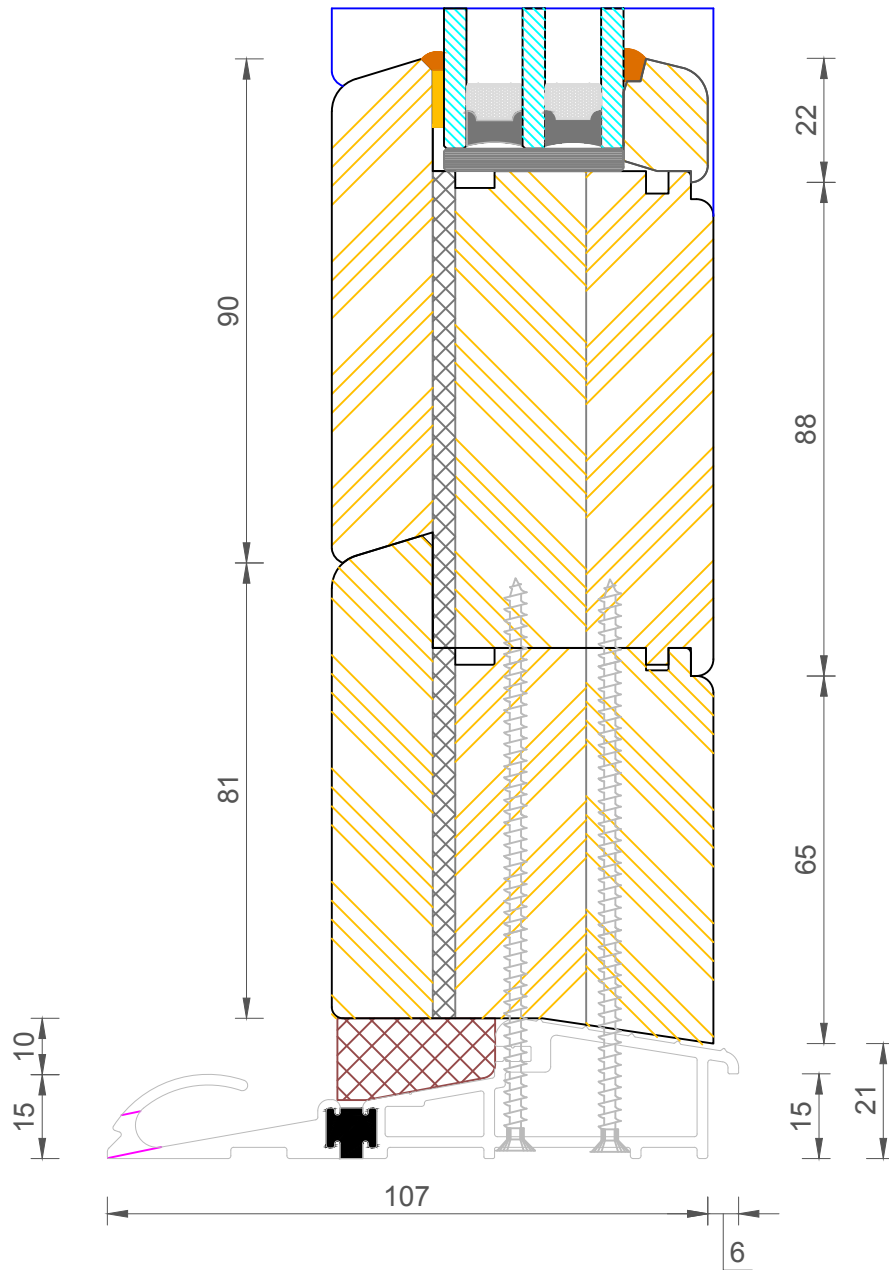

**Contemporary Open Out Lipped French Door  
Triple Glazed - Mobility Thresh**

DIMENSIONS	PLOT SIZE	SCALE	DATE	REV	DWG NO.
MM	A3	1:1	06.05.2014	A	<b>1261</b>
Please consider the environment before printing					



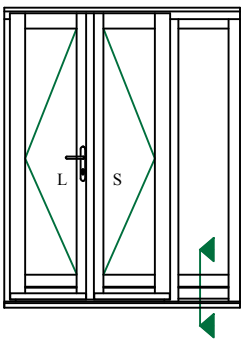
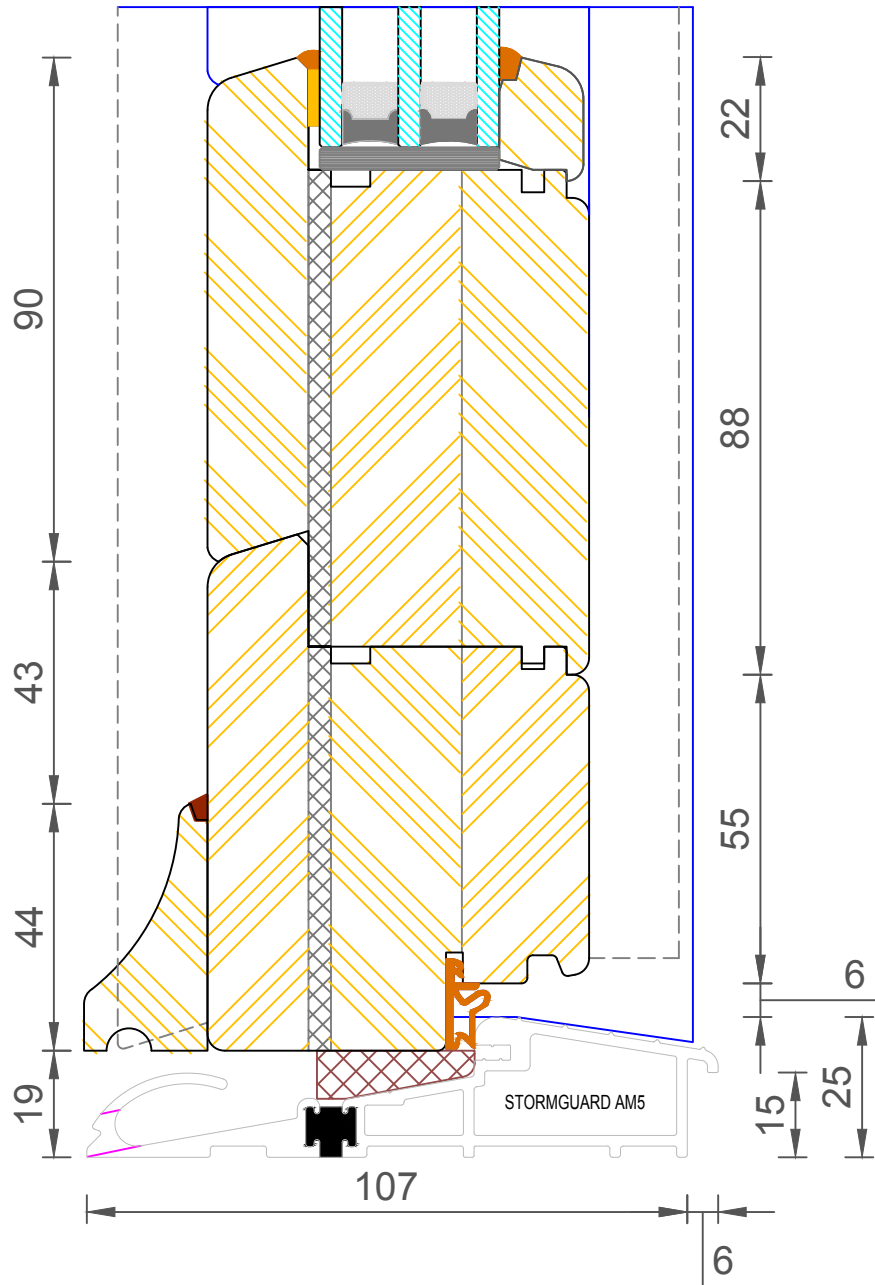

**Contemporary Open Out Lipped French Door**  
**Triple Glazed - Mobility Thresh (Sidelight)**

DIMENSIONS	PLOT SIZE	SCALE	DATE	REV	DWG NO.
MM	A3	1:1	06.05.2014	A	<b>1264</b>

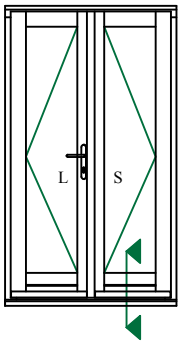
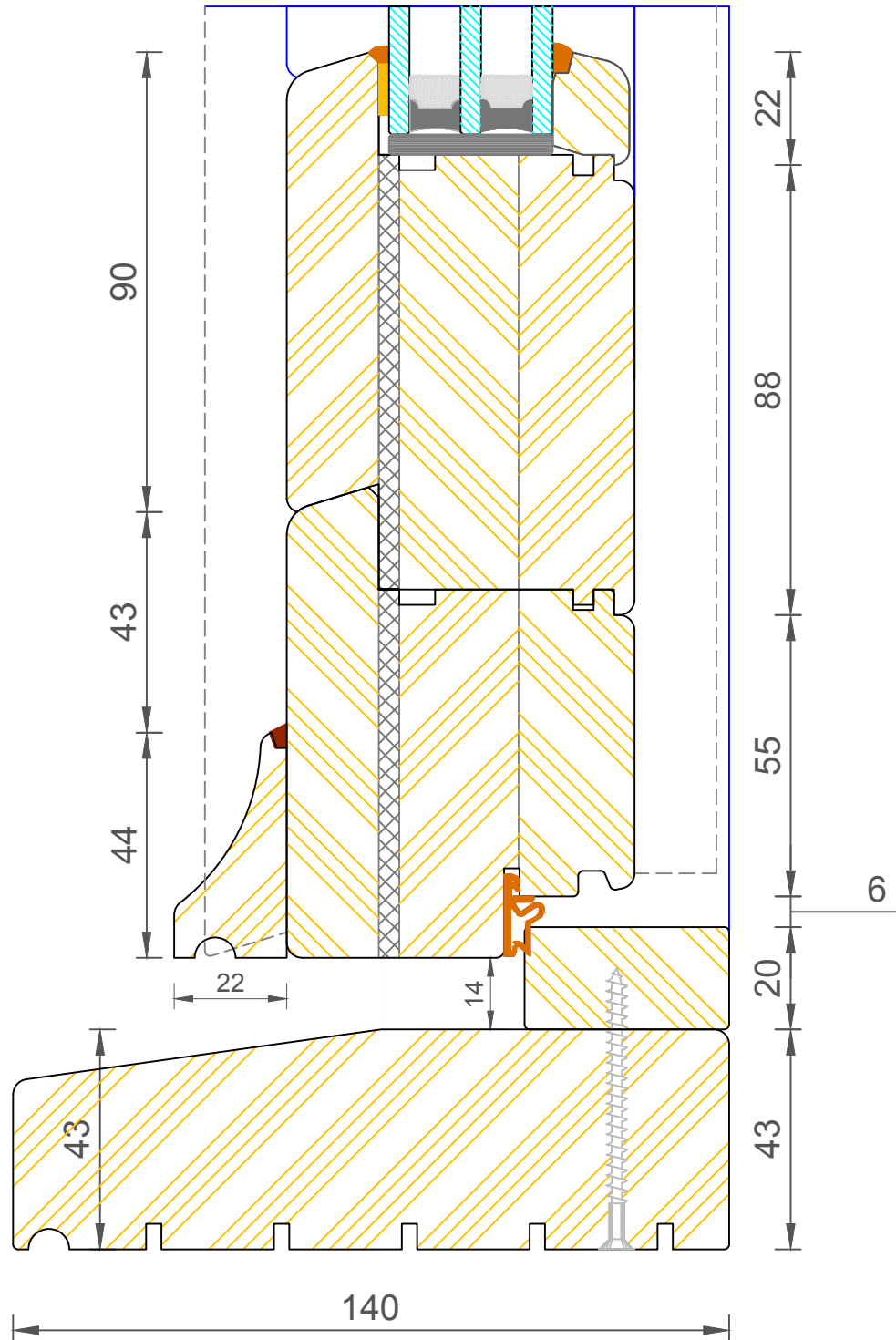

DIMENSIONS	PLOT SIZE	SCALE	DATE	REV	DWG NO.
MM	A3	1:1	06.05.2014	A	<b>1262</b>

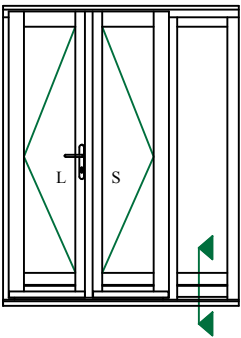
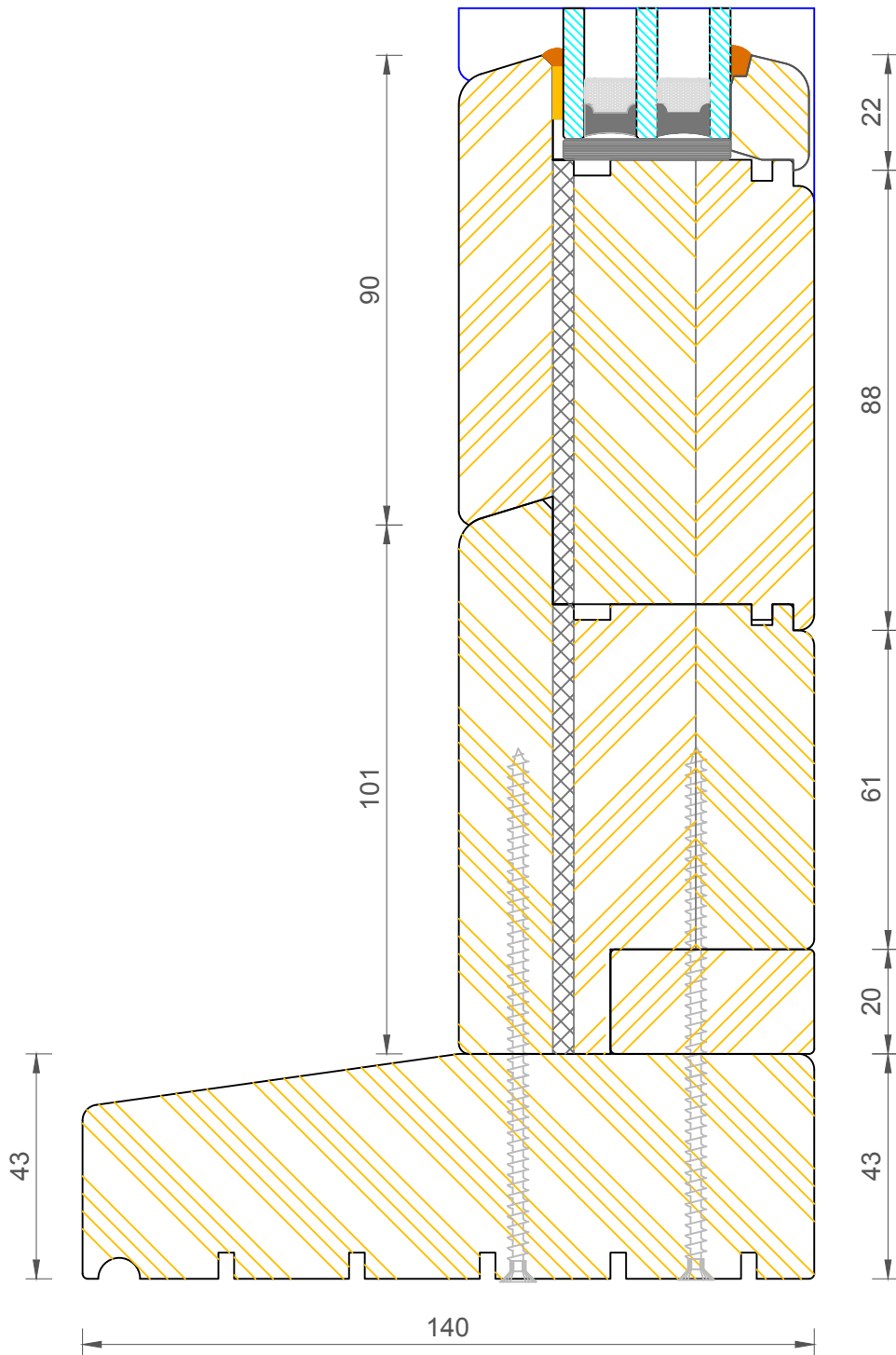

**Contemporary Open Out Lipped French Door  
Triple Glazed - Standard Thresh (Sidelight)**

DIMENSIONS	PLOT SIZE	SCALE	DATE	REV	DWG NO.
MM	A3	1:1	06.05.2014	A	<b>1259</b>

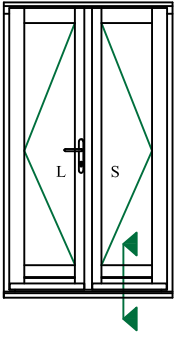
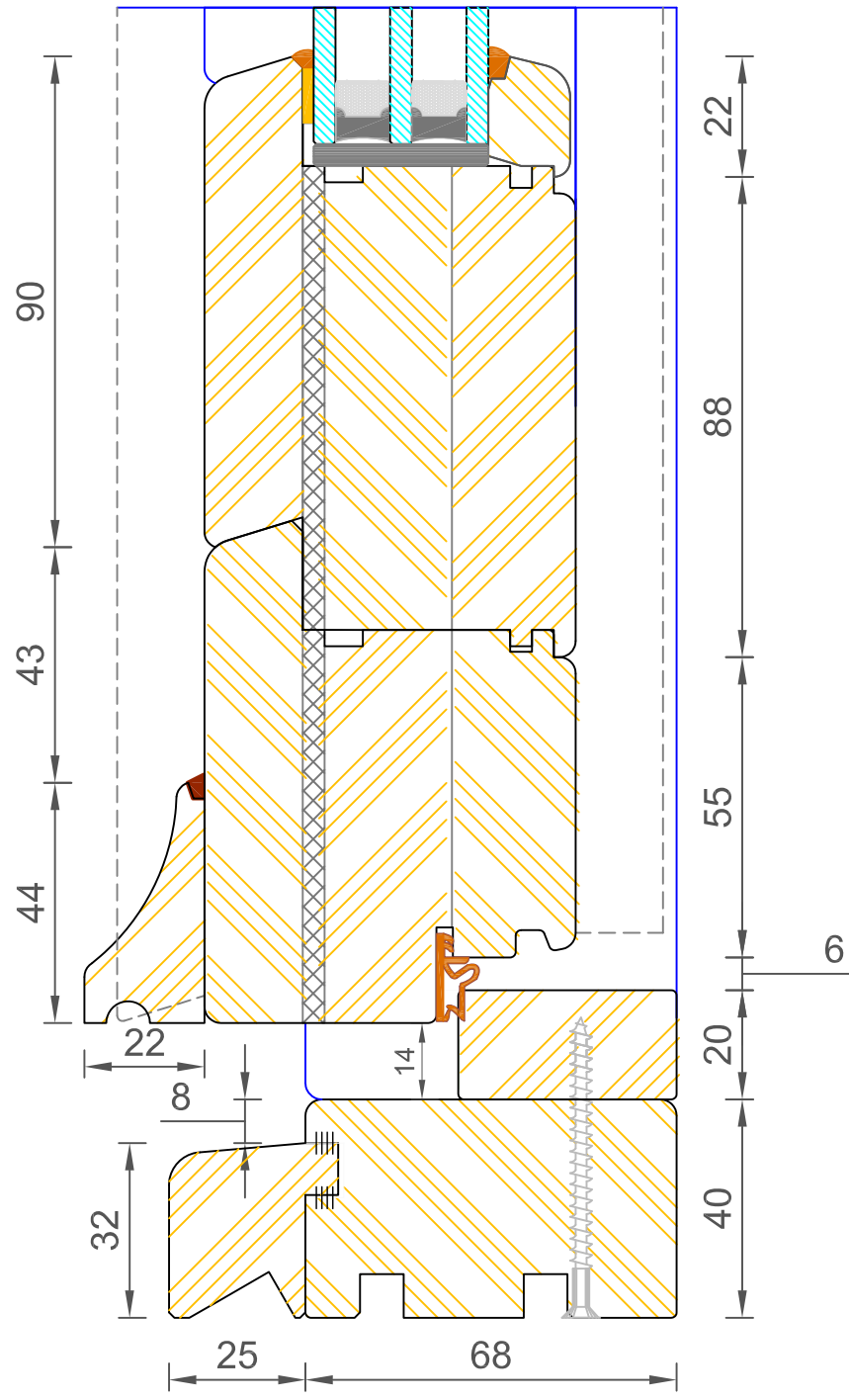

**CILL EXTENSION** - available options: 25mm (93mm o/a) / 47mm (115mm o/a) / 62mm (129mm o/a) / 87mm (155mm o/a) / 114mm (182mm o/a) / 125mm (193mm o/a) / 140mm (208mm o/a)

**NOTE:** Cill Extensions should be supported from underneath; the maximum overhang over Brick / Blockwork for cill extension should not exceed 25mm in order to avoid damage when stepped on. Warranties are invalidated when fitted with overhang in excess to that.

If not otherwise stated, Hardwood Threshold will be painted the same colour as Frame.



**Contemporary Open Out Lipped French Door**  
**Triple Glazed - Coupling Thresh**

DIMENSIONS	PLOT SIZE	SCALE	DATE	REV	DWG NO.
MM	A3	1:1	06.05.2014	A	<b>1263</b>
Please consider the environment before printing					

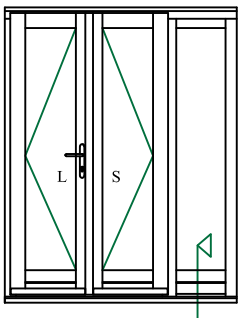
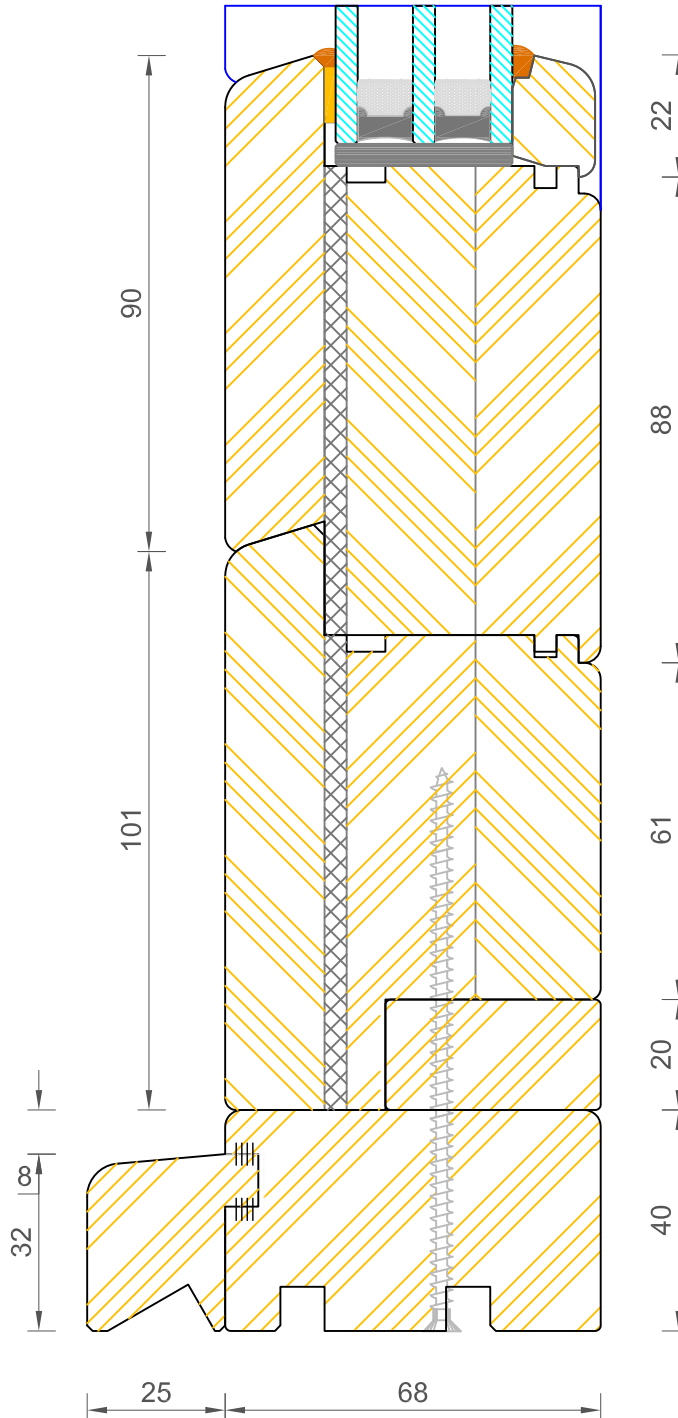

**CILL EXTENSION** - available options: 25mm (93mm o/a) / 47mm (115mm o/a) / 62mm (129mm o/a) / 87mm (155mm o/a) / 114mm (182mm o/a) / 125mm (193mm o/a) / 140mm (208mm o/a)

**NOTE:** Cill Extensions should be supported from underneath; the maximum overhang over Brick / Blockwork for cill extension should not exceed 25mm in order to avoid damage when stepped on. Warranties are invalidated when fitted with overhang in excess to that.

If not otherwise stated, Hardwood Threshold will be painted the same colour as Frame.

### Contemporary Open Out Lipped French Door Triple Glazed - Coupling Thresh (Sidelight)

DIMENSIONS	PLOT SIZE	SCALE	DATE	REV	DWG NO.
MM	A3	1:1	06.05.2014	A	<b>1260</b>
Please consider the environment before printing					