

### Contemporary Open In Lipped French Door Cill Extension Options

DIMENSIONS	PLOT SIZE	SCALE	DATE	REV	DWG NO.
MM	A4	1:1	25.09.2019	B	<b>1301</b>
Please consider the environment before printing					

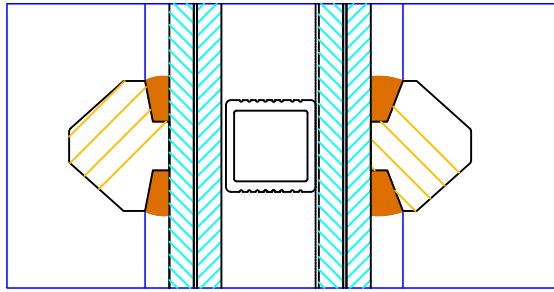

16

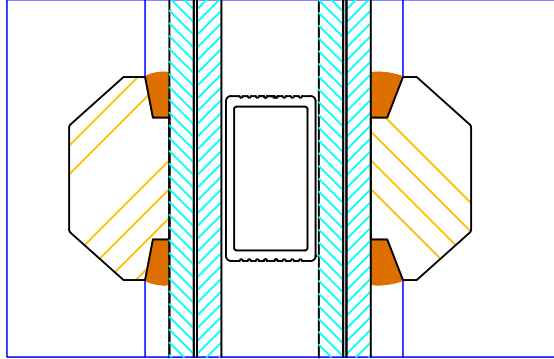

25

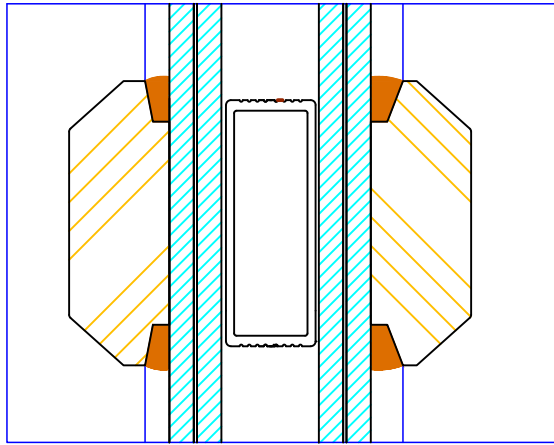

35

60 (varies min 60/ max 137mm)

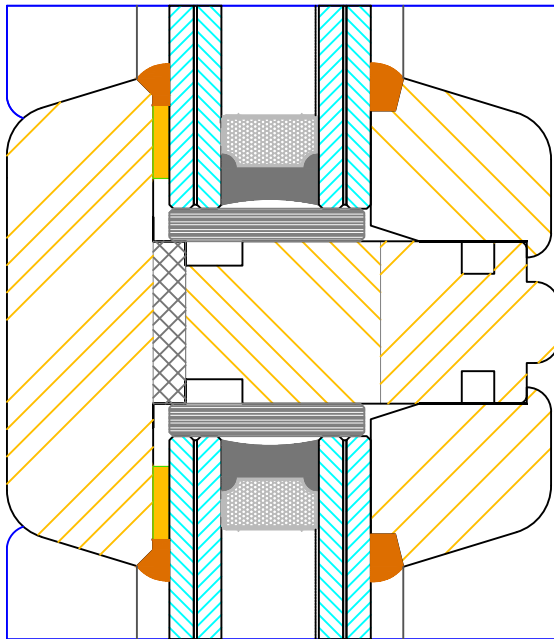

22  
16  
22

DIMENSIONS	PLOT SIZE	SCALE	DATE	REV	DWG NO.
MM	A4	1:1	22.11.2010	A	<b>1302</b>
Please consider the environment before printing					

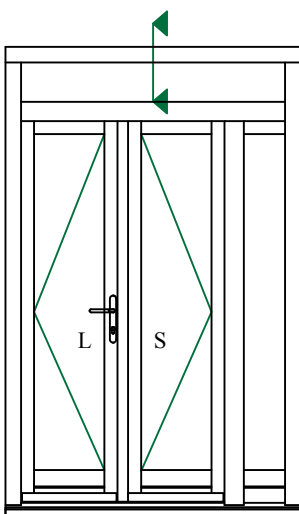
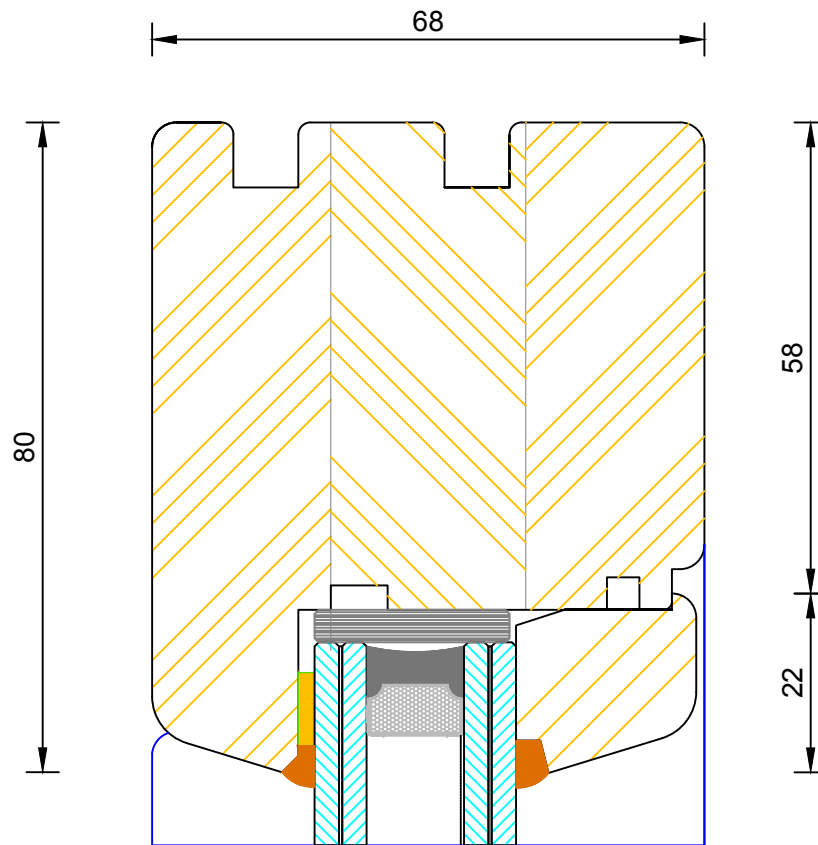

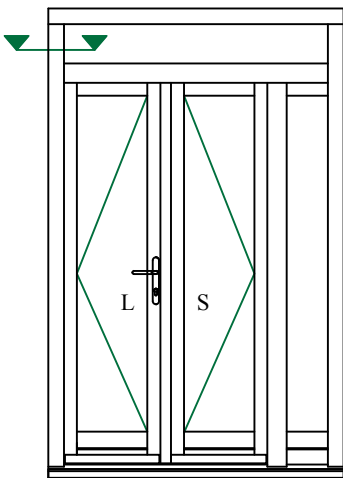
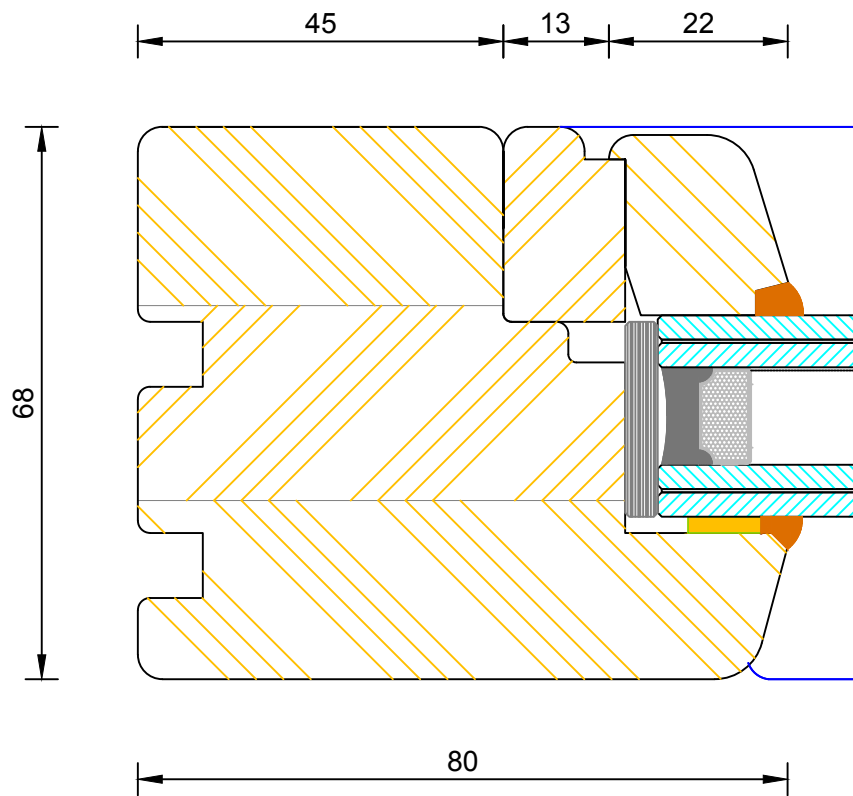

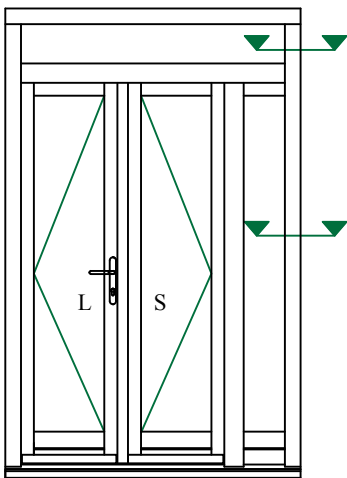
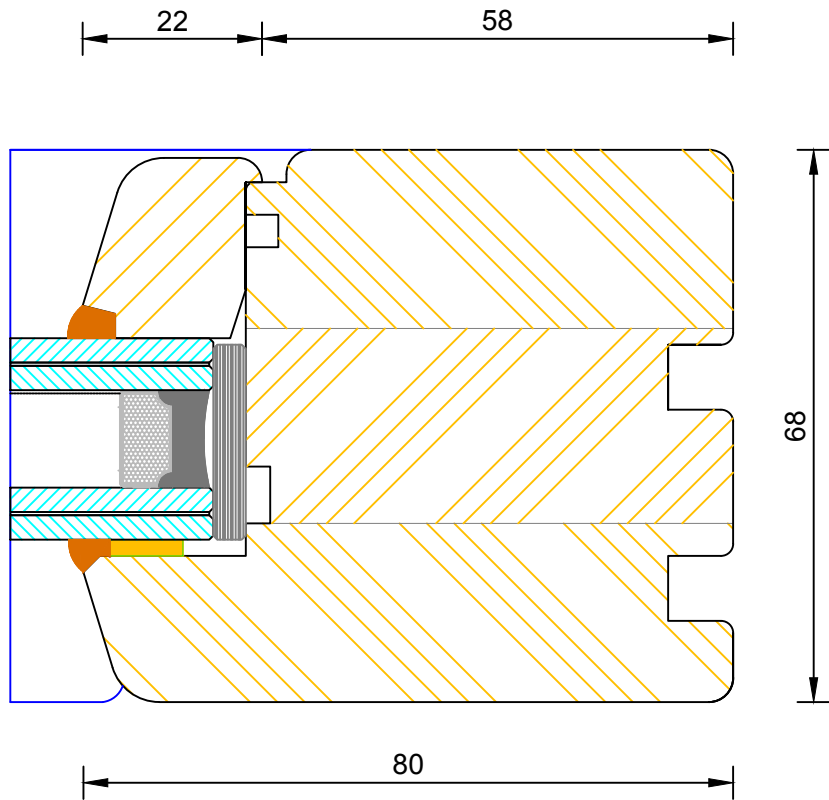

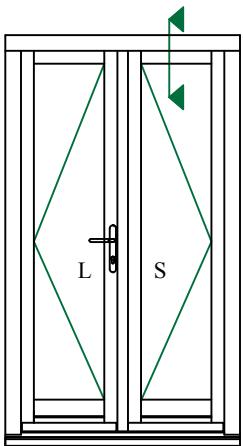
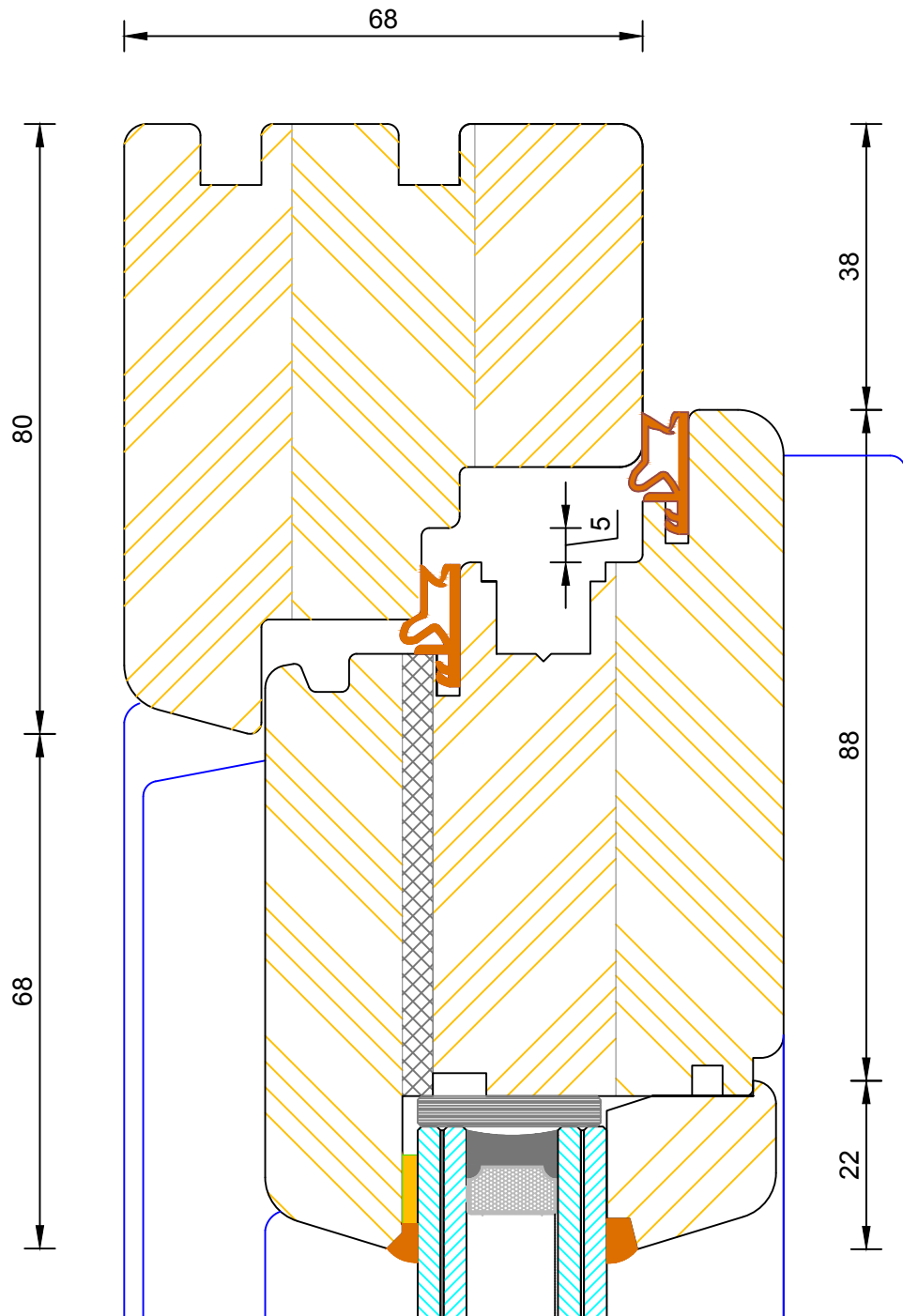

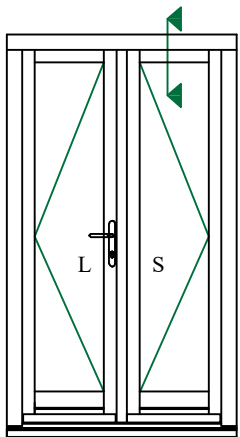
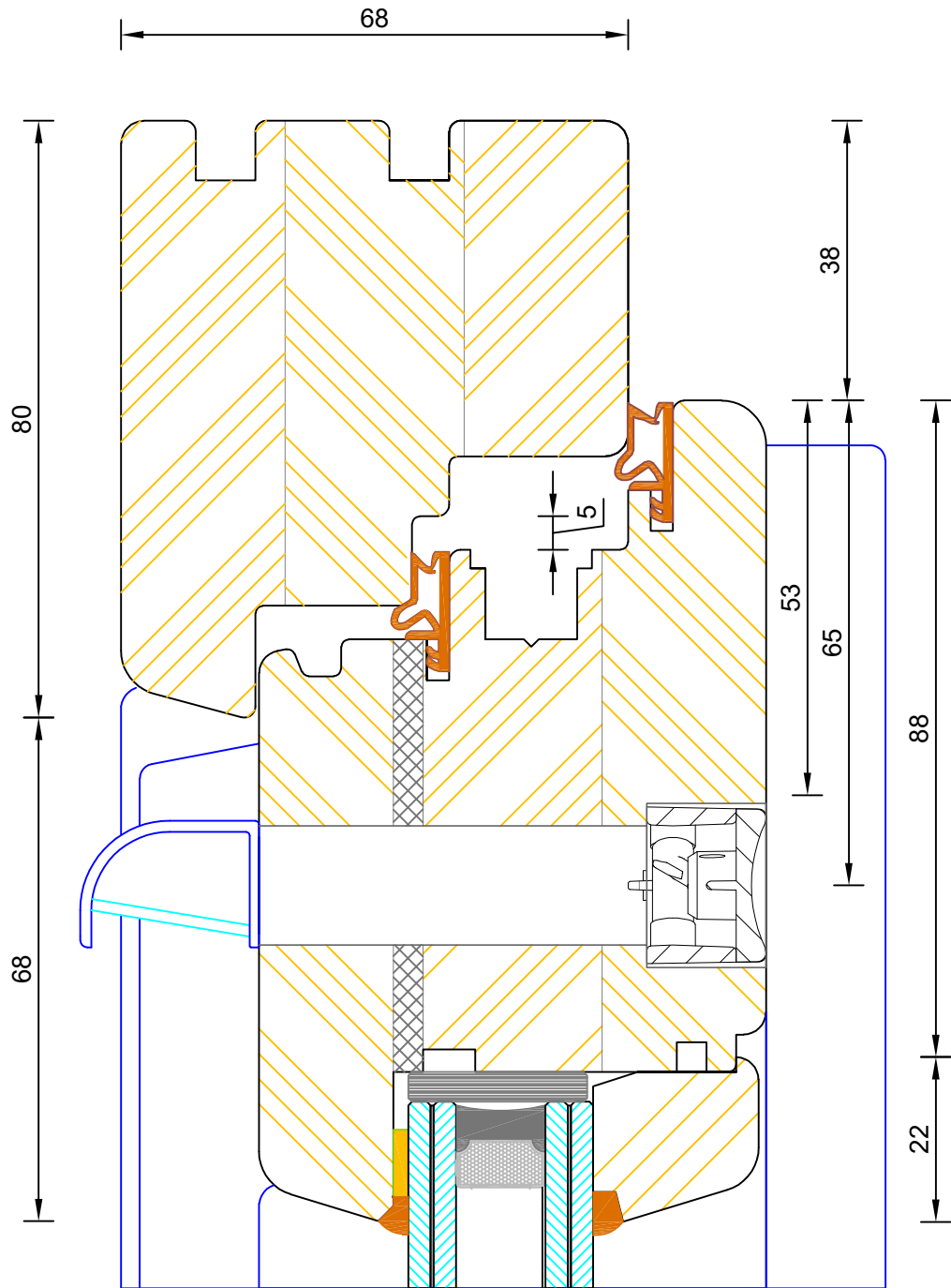

**Contemporary Open In Lipped French Door  
Frame & Leaf Head (Without Vent)**

DIMENSIONS	PLOT SIZE	SCALE	DATE	REV	DWG NO.
MM	A4	1:1	22.11.2010	A	<b>1309</b>



### Contemporary Open In Lipped French Door Frame & Leaf (With Vent in Top Rail)

DIMENSIONS	PLOT SIZE	SCALE	DATE	REV	DWG NO.
MM	A4	1:1	04.07.2022	B	<b>1310</b>
 Please consider the environment before printing					

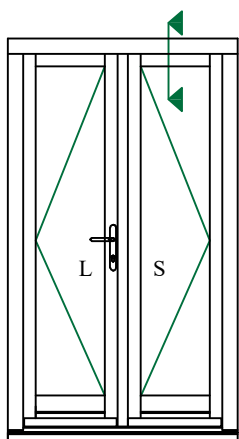
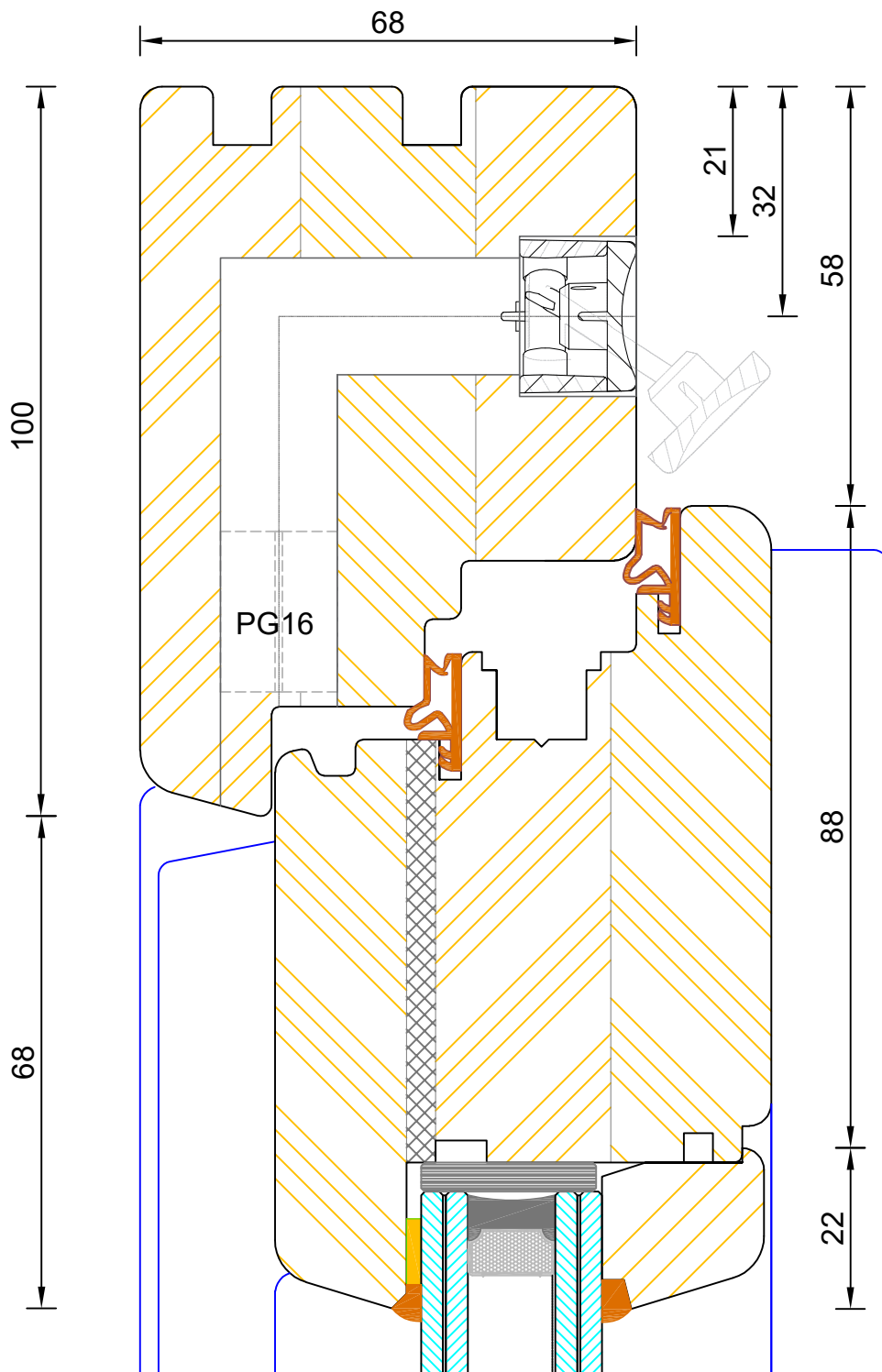

**Contemporary Open In Lipped French Door  
Frame & Leaf (With Vent in Frame Head)**

DIMENSIONS	PLOT SIZE	SCALE	DATE	REV	DWG NO.
MM	A4	1:1	04.07.2022	B	<b>1310.1</b>

Please consider the environment before printing



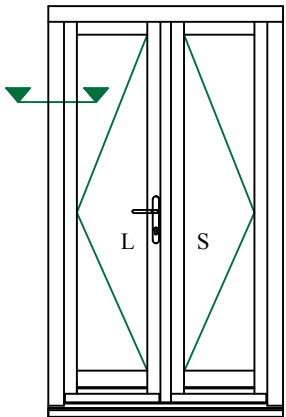
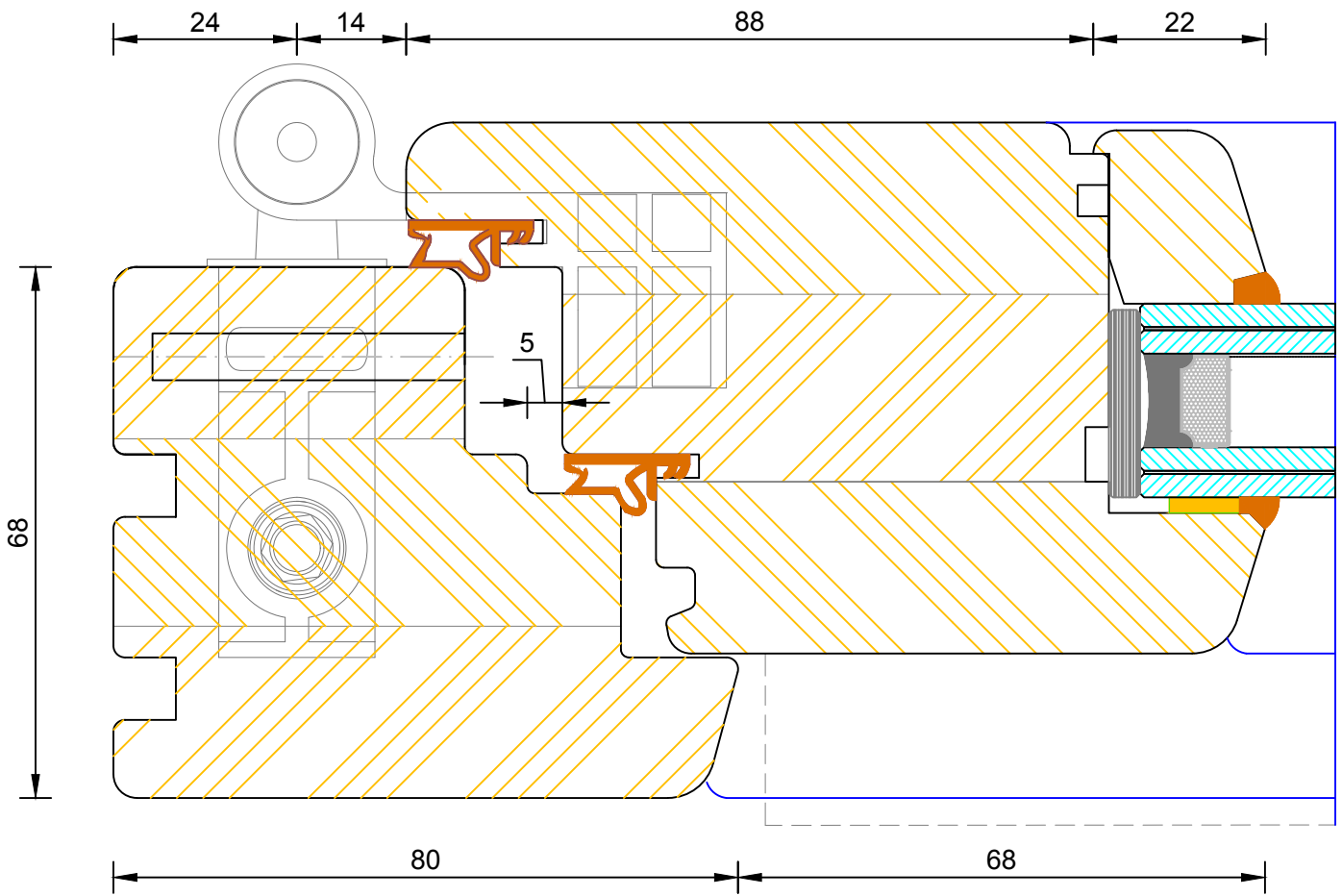

**Contemporary Open In Lipped French Door  
Frame & Leaf Jamb (80mm)**

DIMENSIONS	PLOT SIZE	SCALE	DATE	REV	DWG NO.
MM	A4	1:1	22.11.2010	A	<b>1311</b>
Please consider the environment before printing					

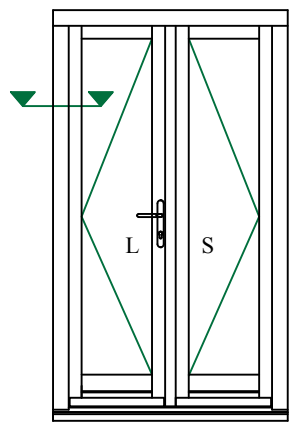
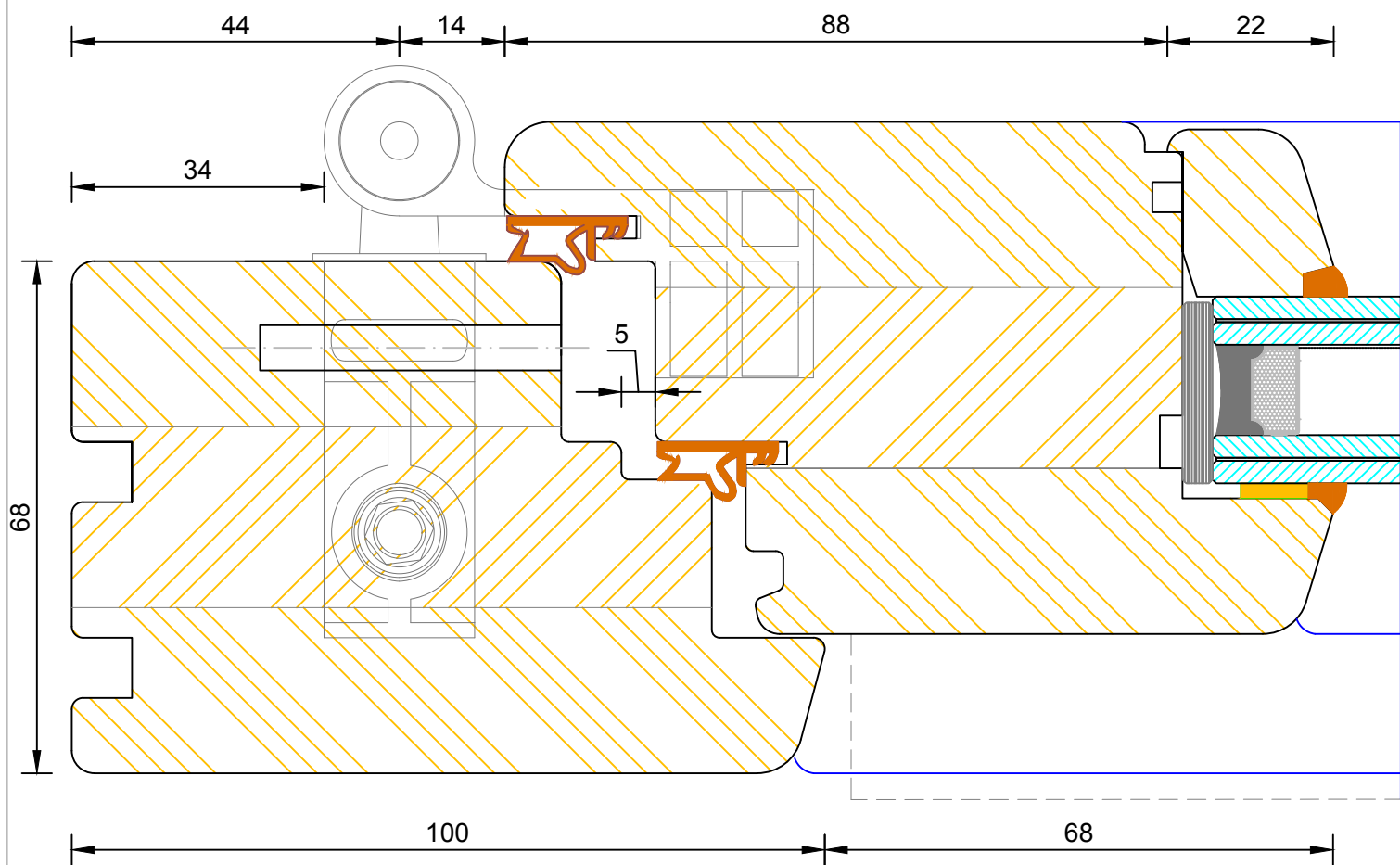

**Contemporary Open In Lipped French Door  
Frame & Leaf Jamb (100mm)**

DIMENSIONS	PLOT SIZE	SCALE	DATE	REV	DWG NO.
MM	A4	1:1	22.11.2010	A	<b>1311.1</b>
Please consider the environment before printing					

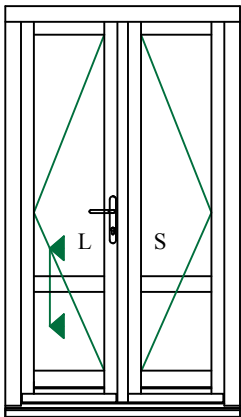
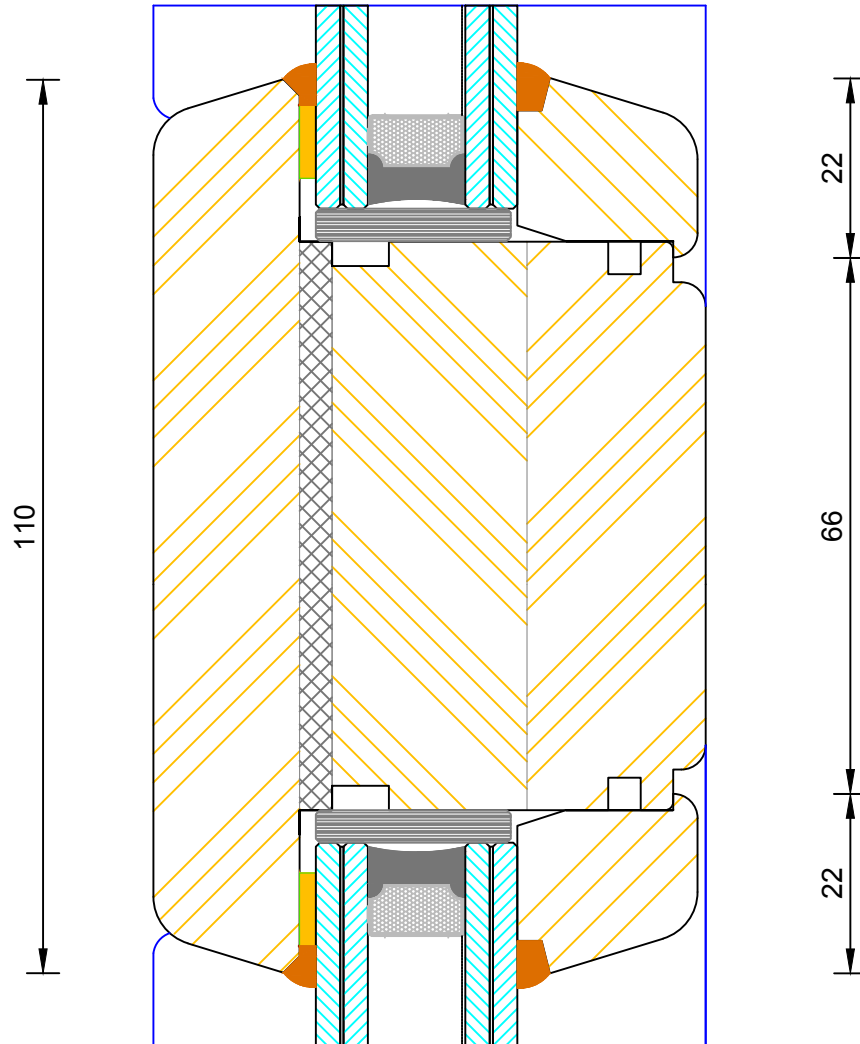

**Contemporary Open In Lipped French Door  
Mid Rail**

DIMENSIONS	PLOT SIZE	SCALE	DATE	REV	DWG NO.
MM	A4	1:1	22.11.2010	A	<b>1315</b>
Please consider the environment before printing					

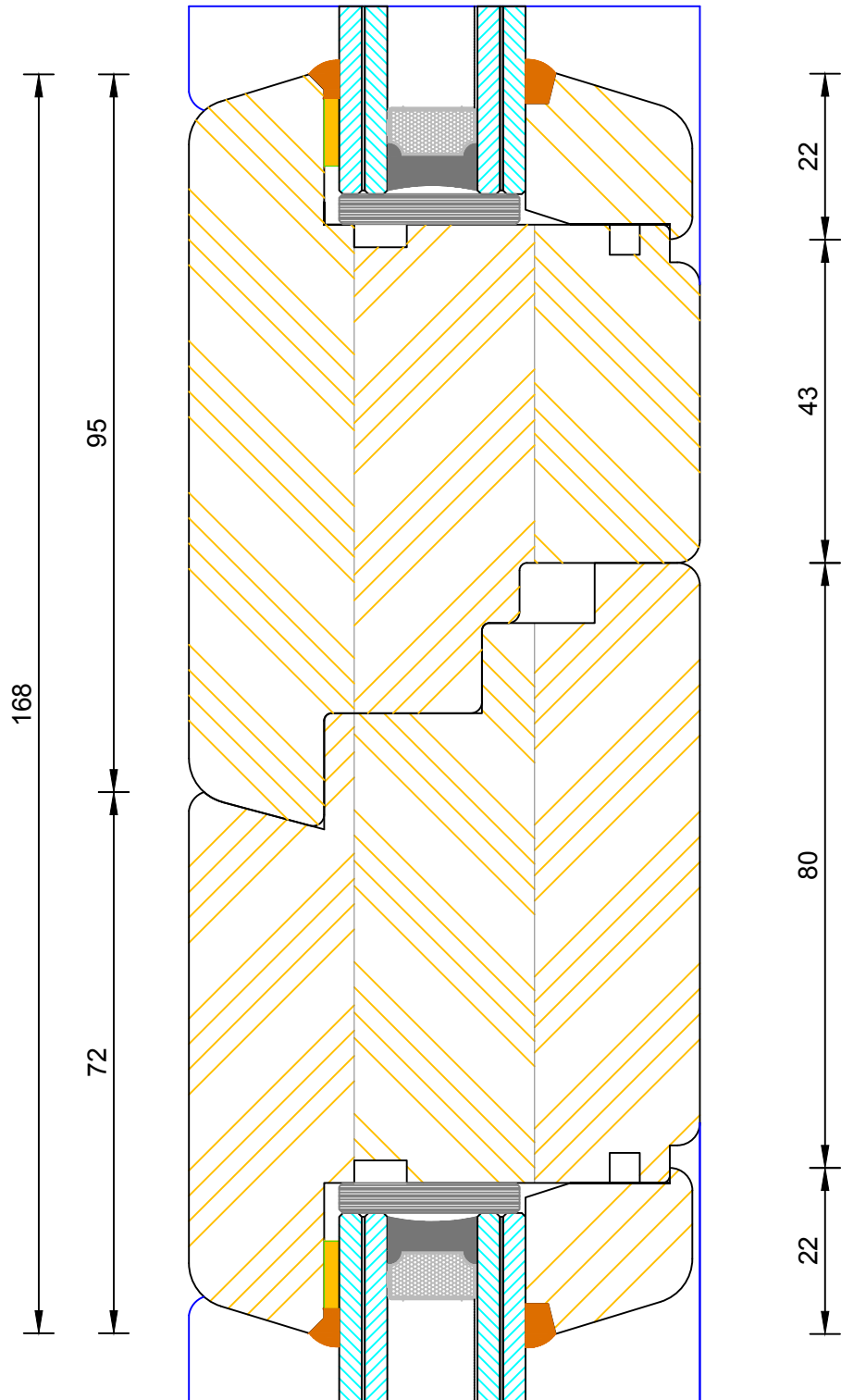
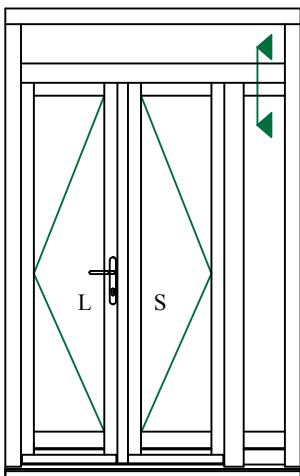

**Contemporary Open In Lipped French Door  
Fanlight / Sidelight Transom**

DIMENSIONS	PLOT SIZE	SCALE	DATE	REV	DWG NO.
MM	A4	1:1	22.11.2010	A	<b>1316</b>
Please consider the environment before printing					

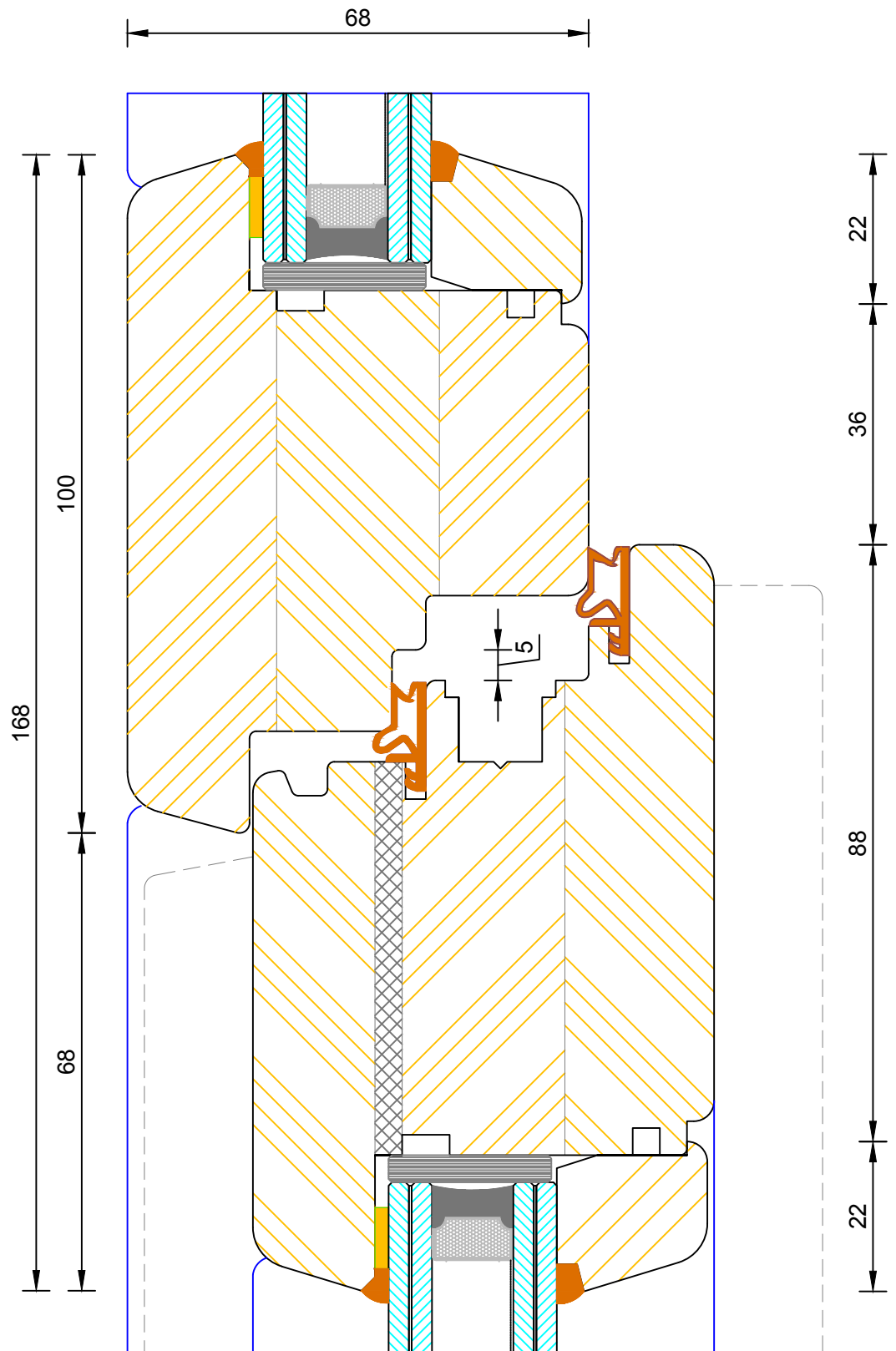
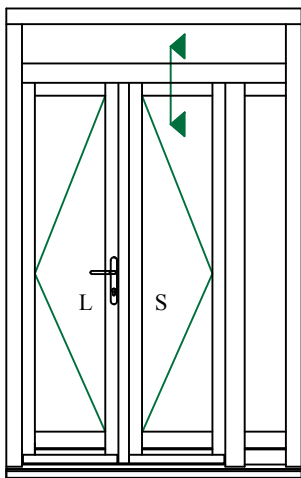

### Contemporary Open In Lipped French Door Fanlight Transom (Leaf Without Vent)

DIMENSIONS	PLOT SIZE	SCALE	DATE	REV	DWG NO.
MM	A4	1:1	22.11.2010	A	<b>1317</b>

Please consider the environment before printing

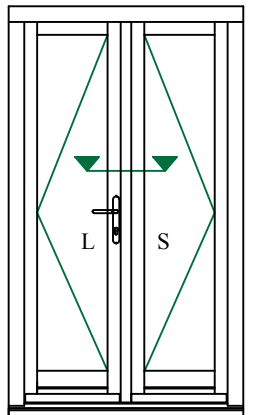
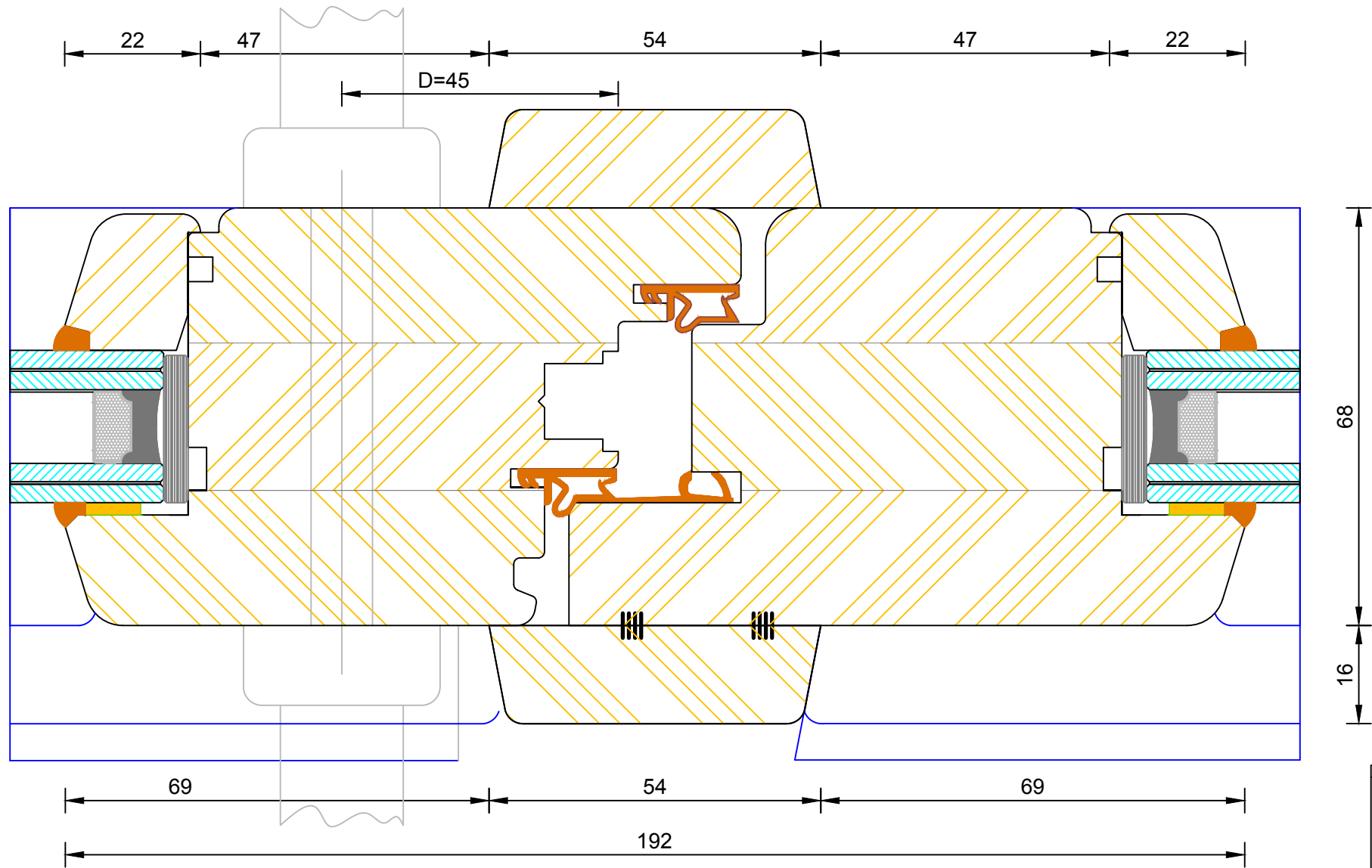

**Contemporary Open In Lipped French Door  
Flying Mullion (Single Handle)**

DIMENSIONS	PLOT SIZE	SCALE	DATE	REV	DWG NO.
MM	A4	1:1	22.11.2010	A	<b>1319</b>

Please consider the environment before printing

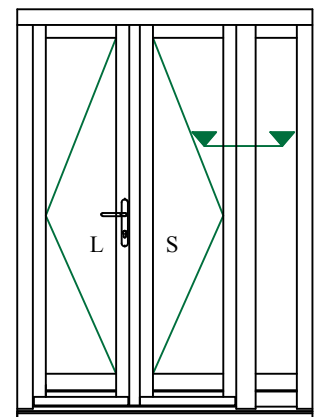
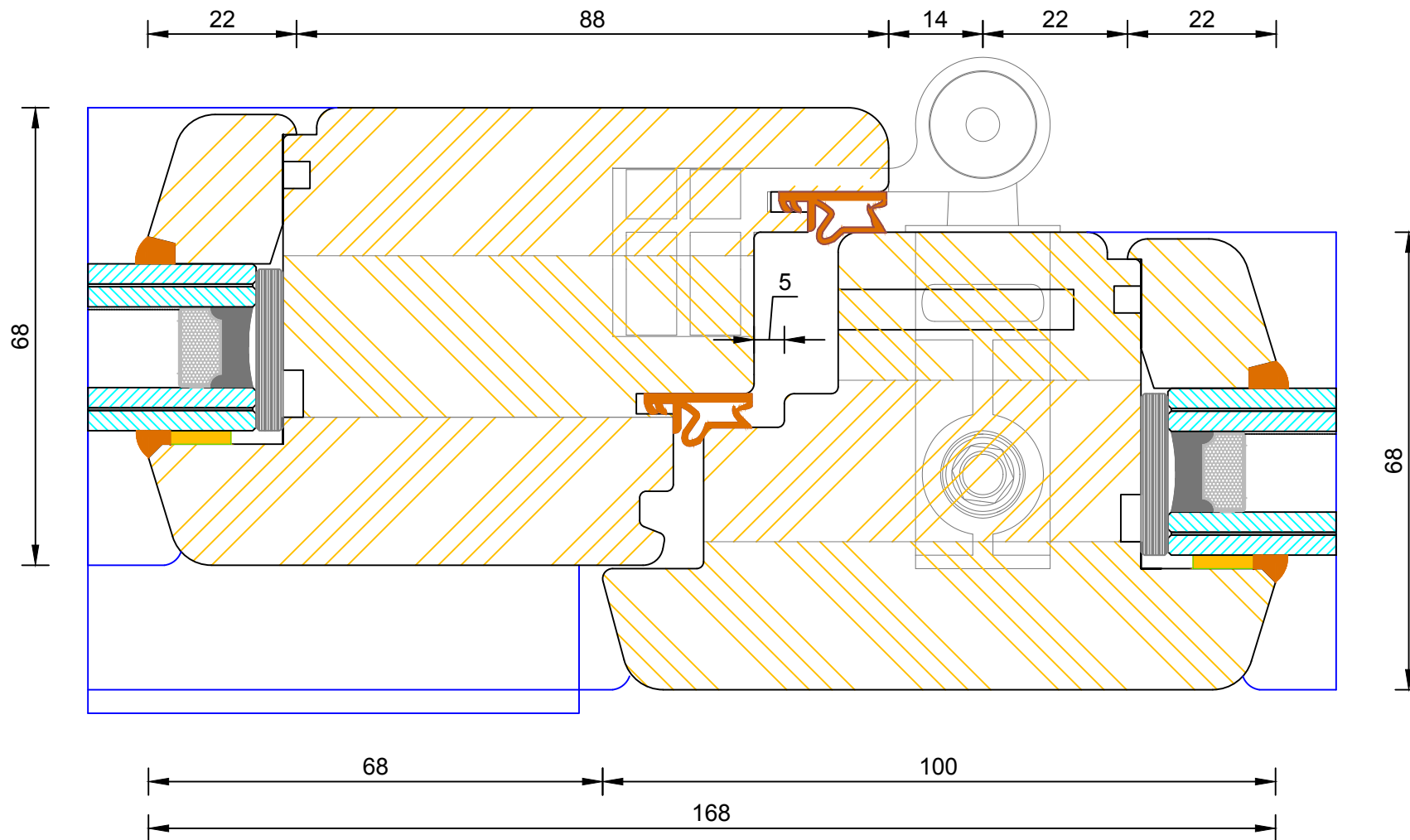

**Contemporary Open In Lipped French Door  
Solid Mullion**

DIMENSIONS	PLOT SIZE	SCALE	DATE	REV	DWG NO.
MM	A4	1:1	22.11.2010	A	<b>1320</b>
Please consider the environment before printing					

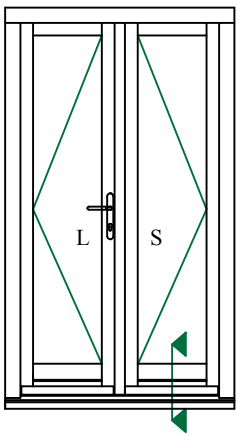
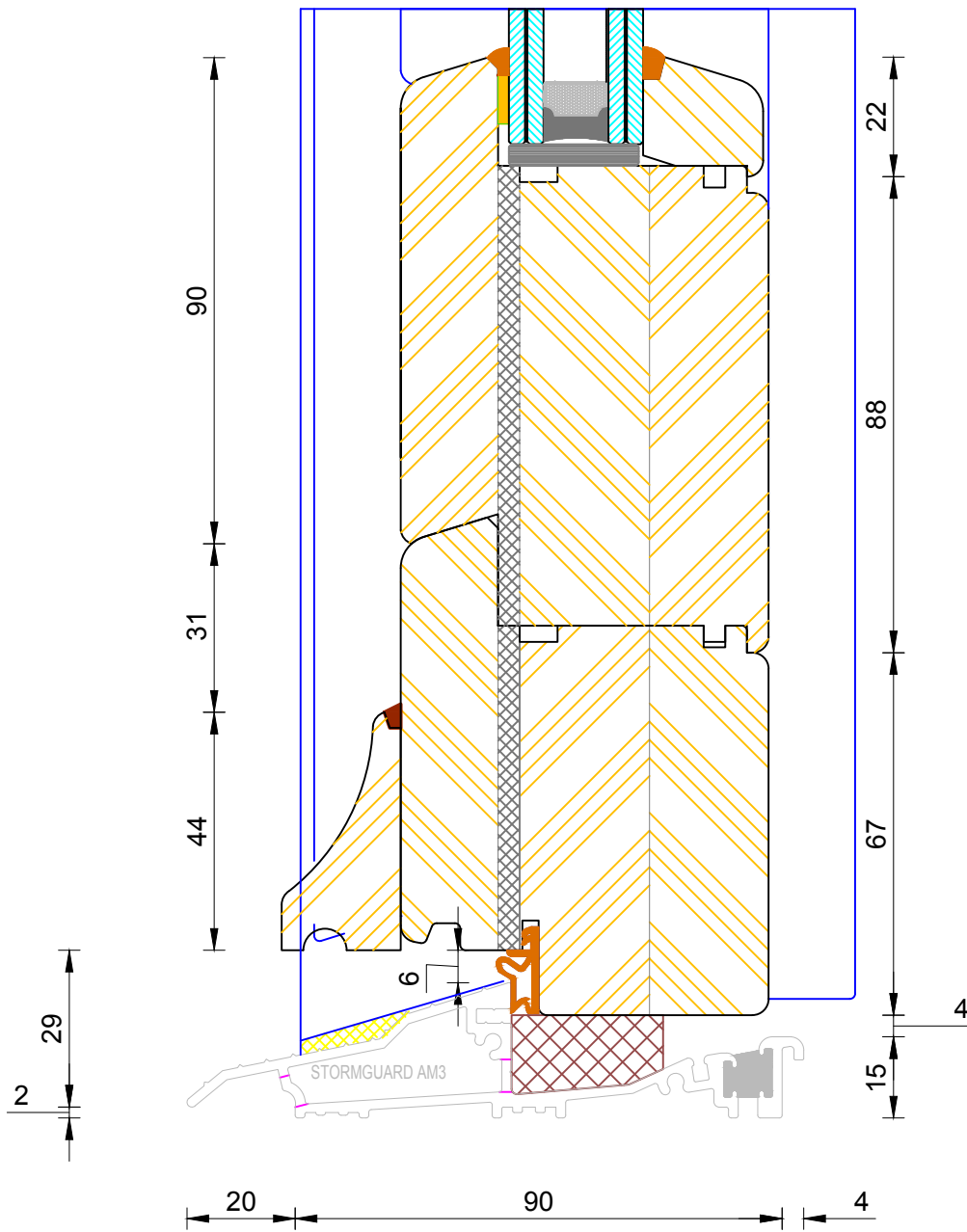



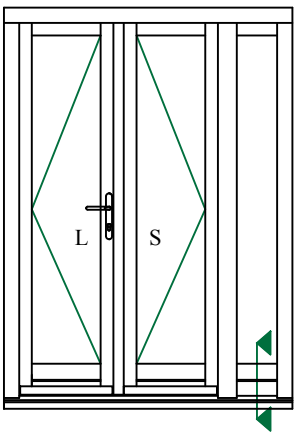
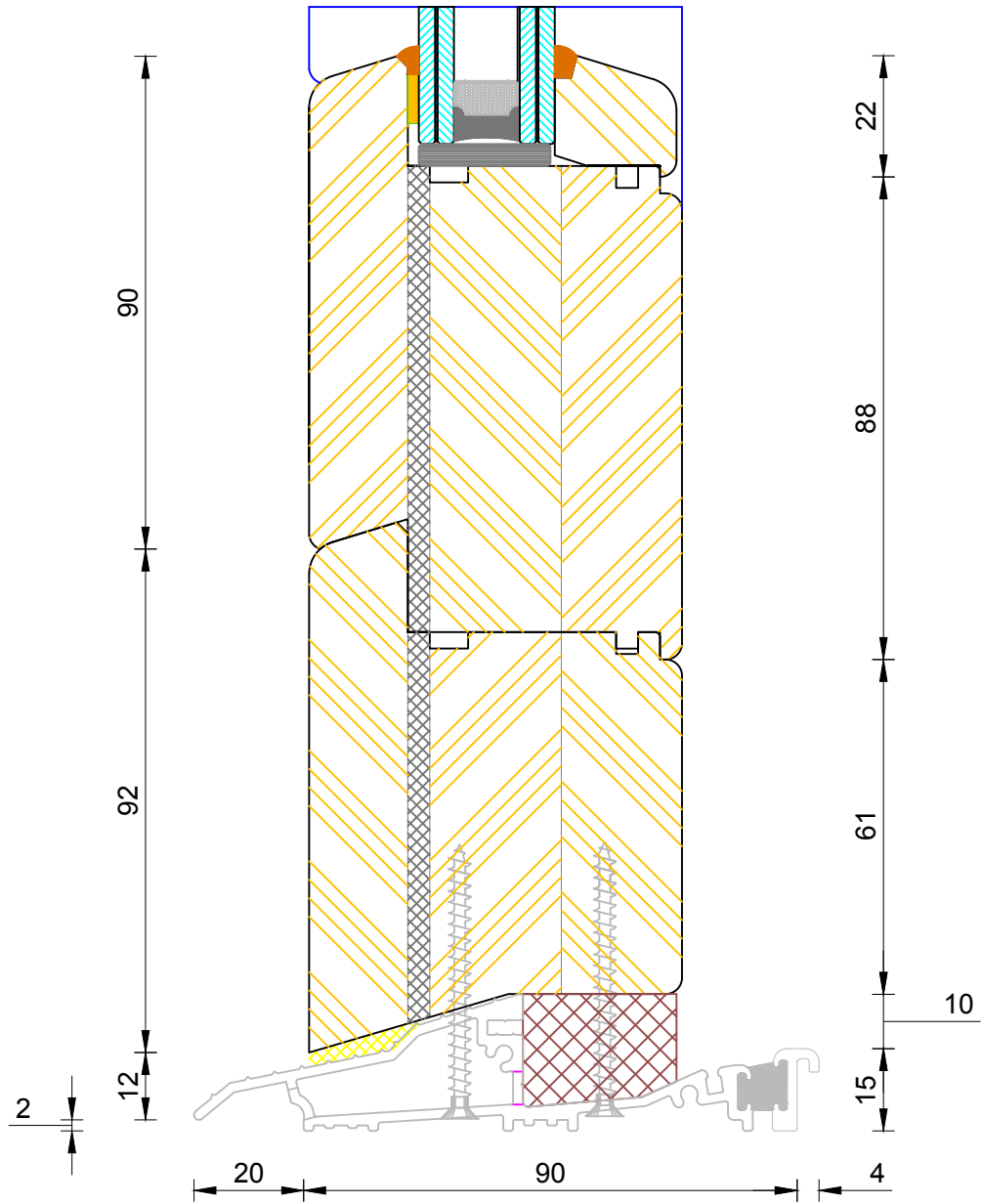

### Contemporary Open In Lipped French Door Mobility Thresh (Sidelight)

DIMENSIONS	PLOT SIZE	SCALE	DATE	REV	DWG NO.
MM	A3	1:1	22.11.2010	A	<b>1364</b>

Please consider the environment before printing

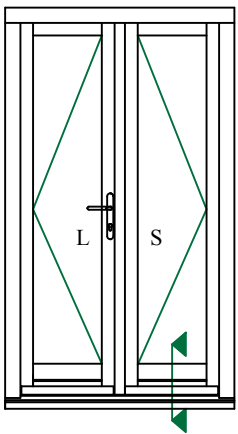
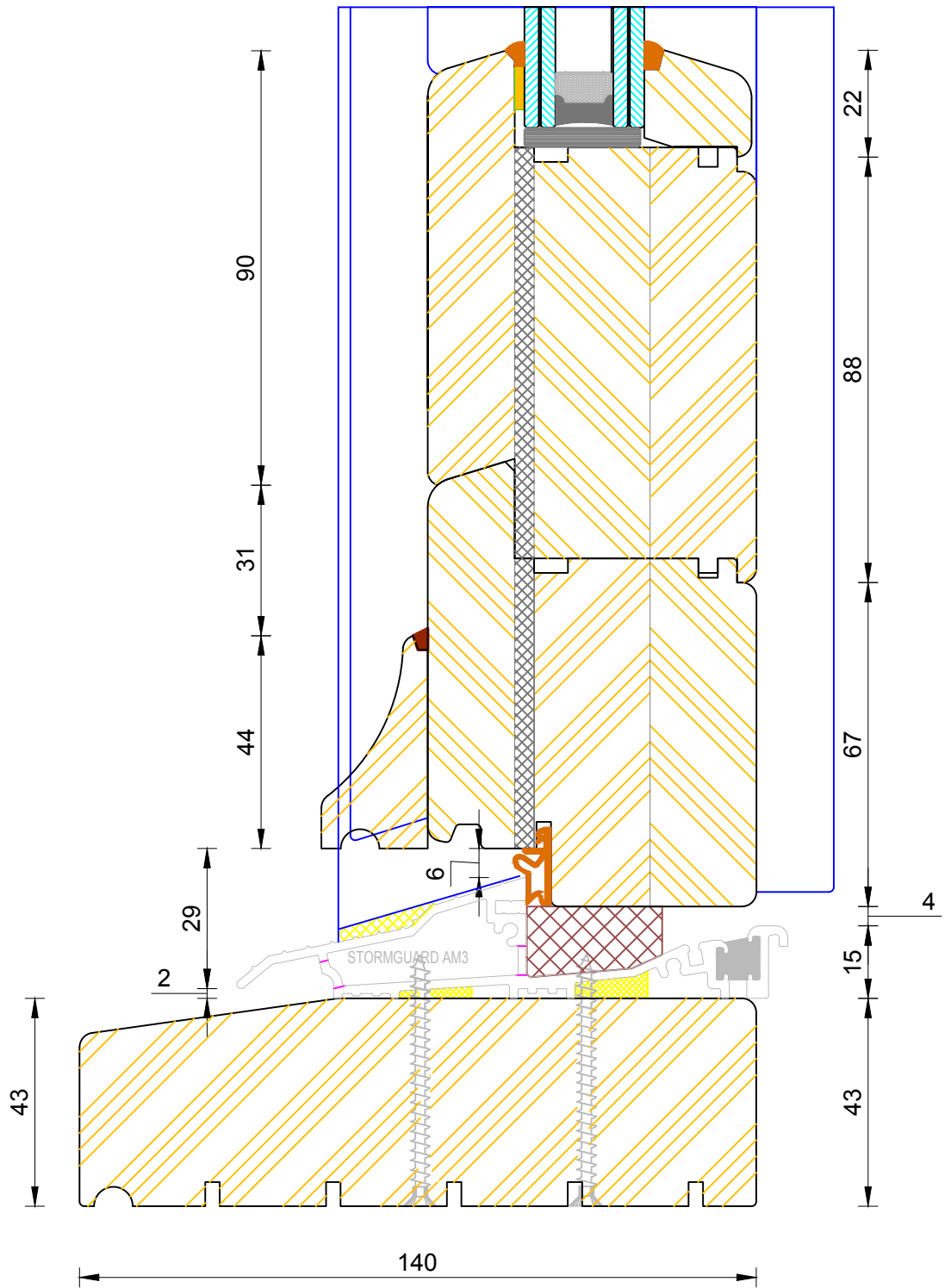

**Contemporary Open In Lipped French Door  
Standard Thresh**

DIMENSIONS	PLOT SIZE	SCALE	DATE	REV	DWG NO.
MM	A3	1:1	22.11.2010	A	<b>1368</b>

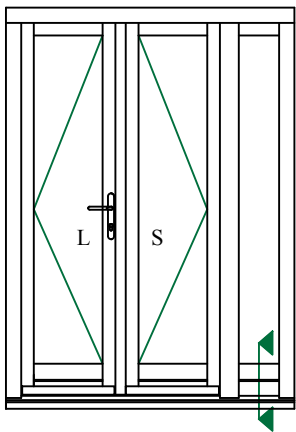
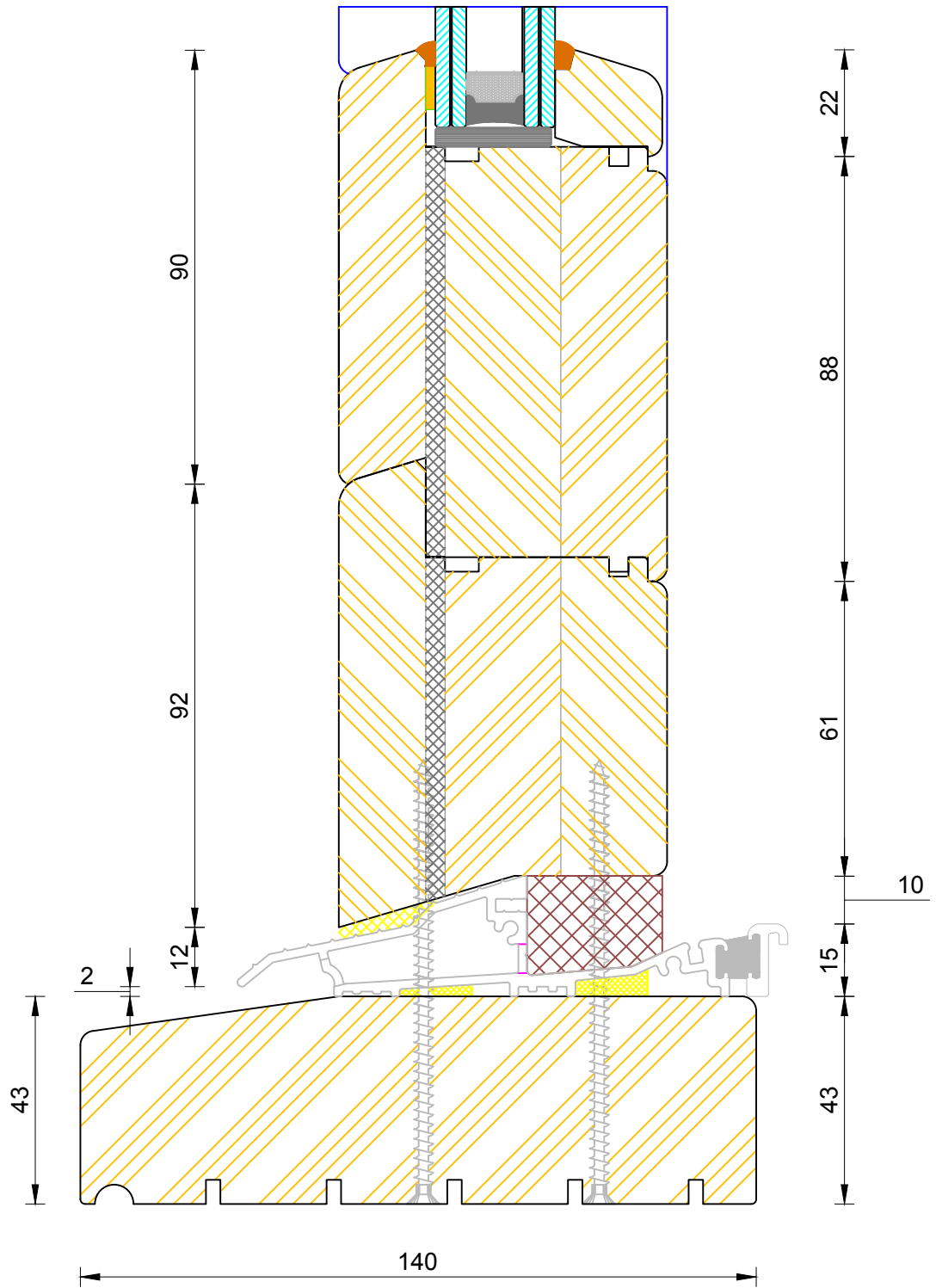

**Contemporary Open In Lipped French Door  
Standard Thresh (Sidelight)**

DIMENSIONS	PLOT SIZE	SCALE	DATE	REV	DWG NO.
MM	A3	1:1	22.11.2010	A	<b>1369</b>
Please consider the environment before printing					

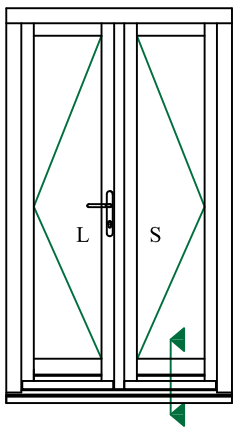
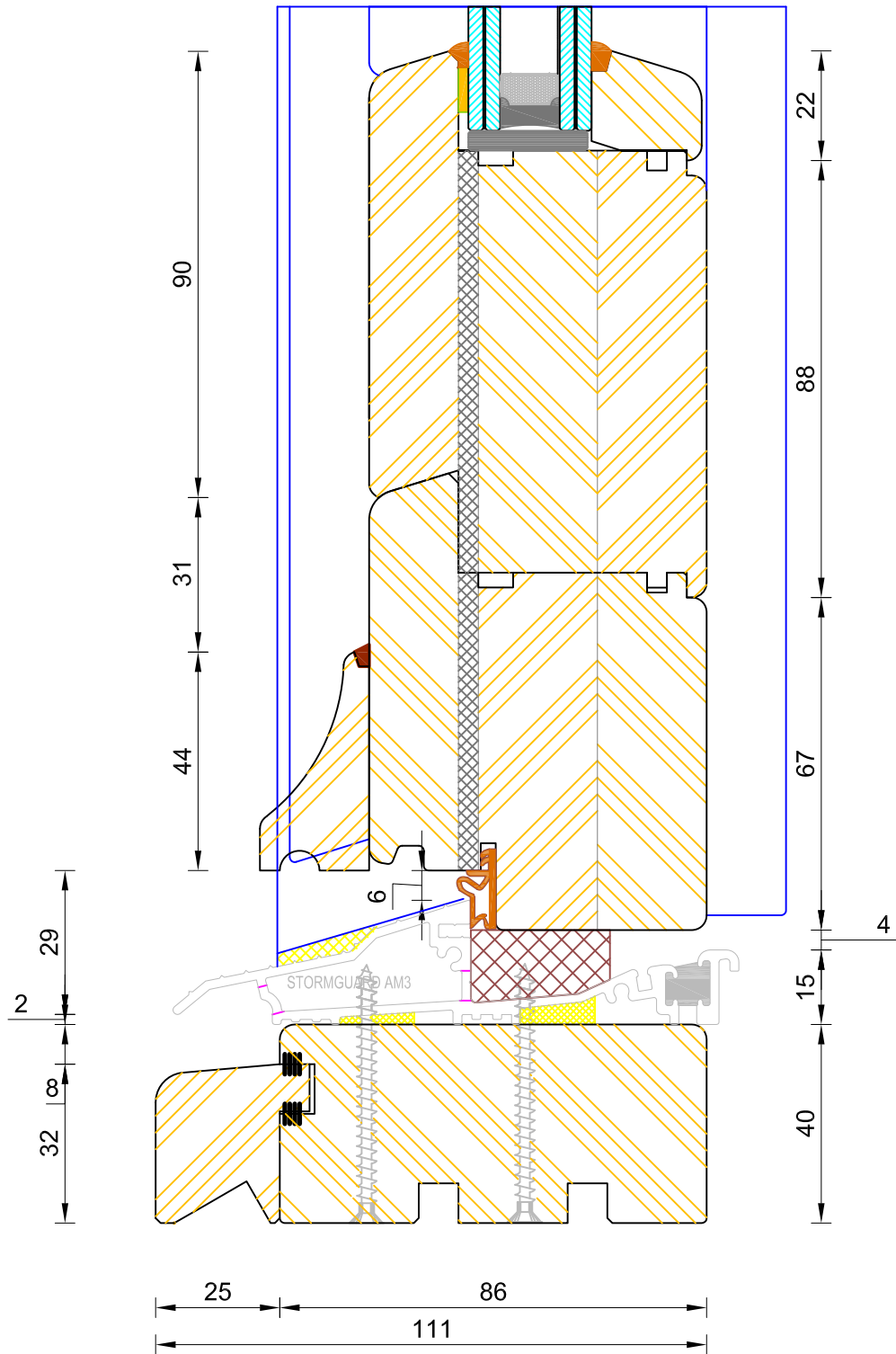

CILL EXTENSION - available options: 25mm (111mm o/a) / 47mm (133mm o/a) / 62mm (148mm o/a) / 87mm (173mm o/a) / 114mm (200mm o/a) / 125mm (211mm o/a) / 140mm (223mm o/a)

NOTE: Cill Extensions should be supported from underneath; the maximum overhang over Brick / Blockwork for cill extension should not exceed 25mm in order to avoid damage when stepped on. Warranties are invalidated when fitted with overhang in excess to that.

If not otherwise stated, Hardwood Threshold will be painted the same colour as Frame.



### Contemporary Open In Lipped French Door Coupling Thresh

DIMENSIONS	PLOT SIZE	SCALE	DATE	REV	DWG NO.
MM	A3	1:1	22.11.2010	A	1372
Please consider the environment before printing					

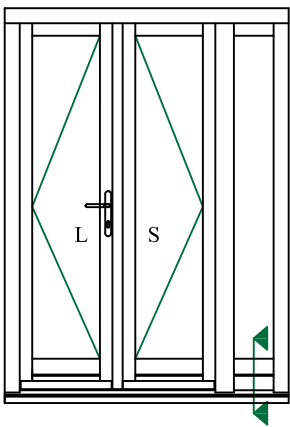
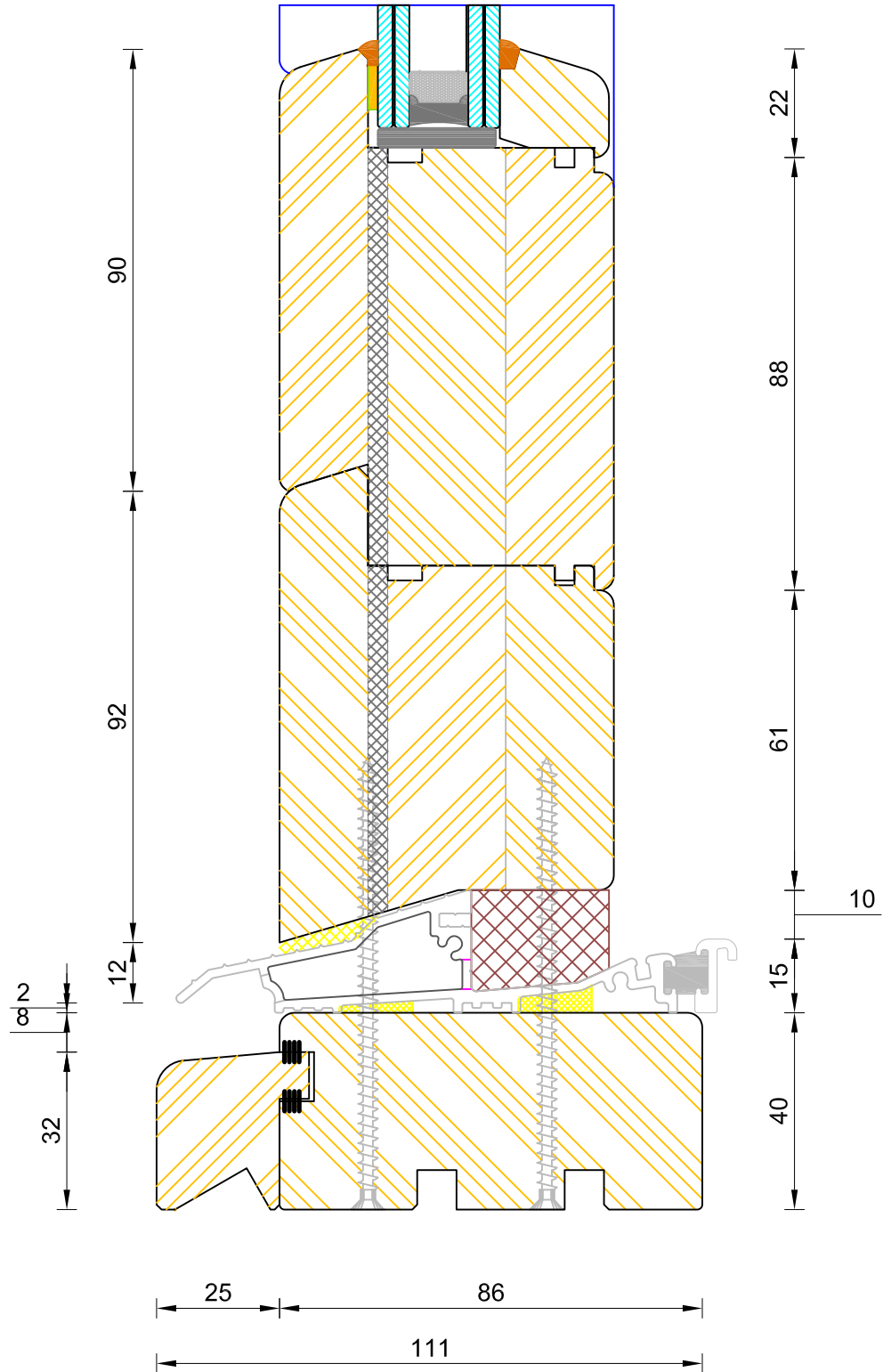

CILL EXTENSION - available options: 25mm (111mm o/a) / 47mm (133mm o/a) / 62mm (148mm o/a) / 87mm (173mm o/a) / 114mm (200mm o/a) / 125mm (211mm o/a) / 140mm (223mm o/a)

NOTE: Cill Extensions should be supported from underneath; the maximum overhang over Brick / Blockwork for cill extension should not exceed 25mm in order to avoid damage when stepped on. Warranties are invalidated when fitted with overhang in excess to that.

If not otherwise stated, Hardwood Threshold will be painted the same colour as Frame.



### Contemporary Open In Lipped French Door Coupling Thresh (Sidelight)

DIMENSIONS	PLOT SIZE	SCALE	DATE	REV	DWG NO.
MM	A3	1:1	22.11.2010	A	<b>1373</b>
Please consider the environment before printing					