

**Contemporary Open In Lipped French Door
Triple Glazed - Cill Extension Options**

DIMENSIONS	PLOT SIZE	SCALE	DATE	REV	DWG NO.
MM	A4	1:1	25.09.2019	B	1357
Please consider the environment before printing					

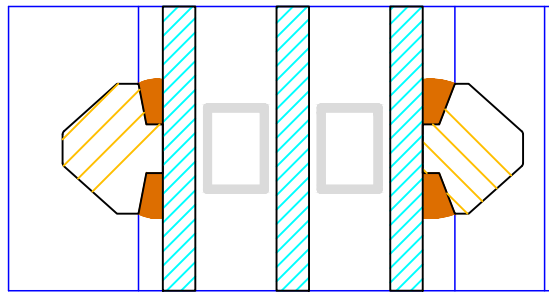

16

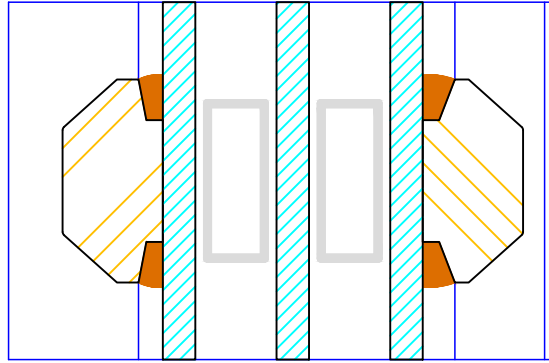

25

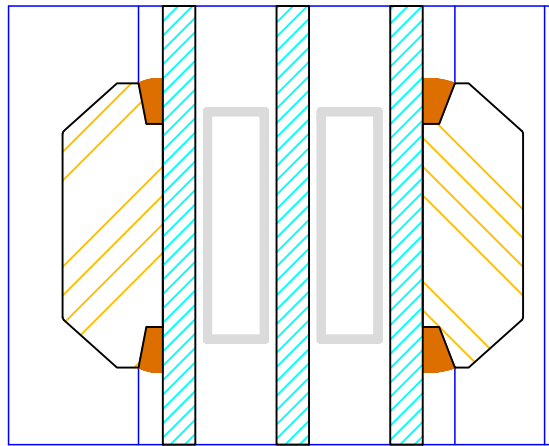

35

60 (varies min 60 / max 110mm)

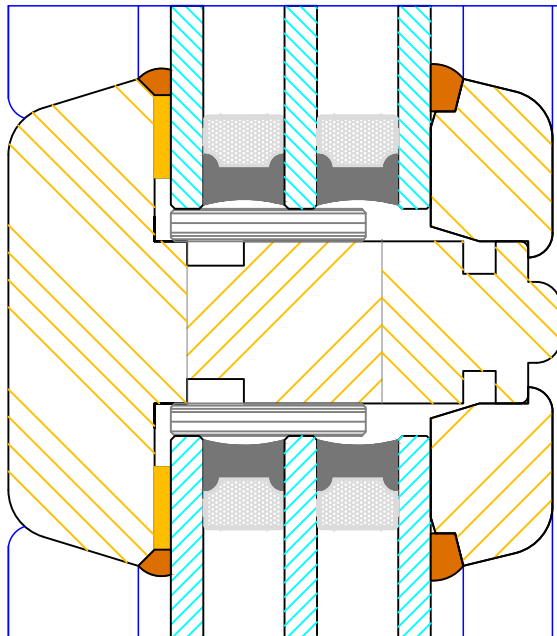

22
16
22

68

DIMENSIONS	PLOT SIZE	SCALE	DATE	REV	DWG NO.
MM	A4	1:1	22.11.2010	A	1342

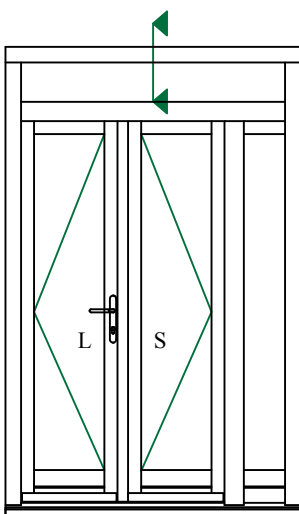
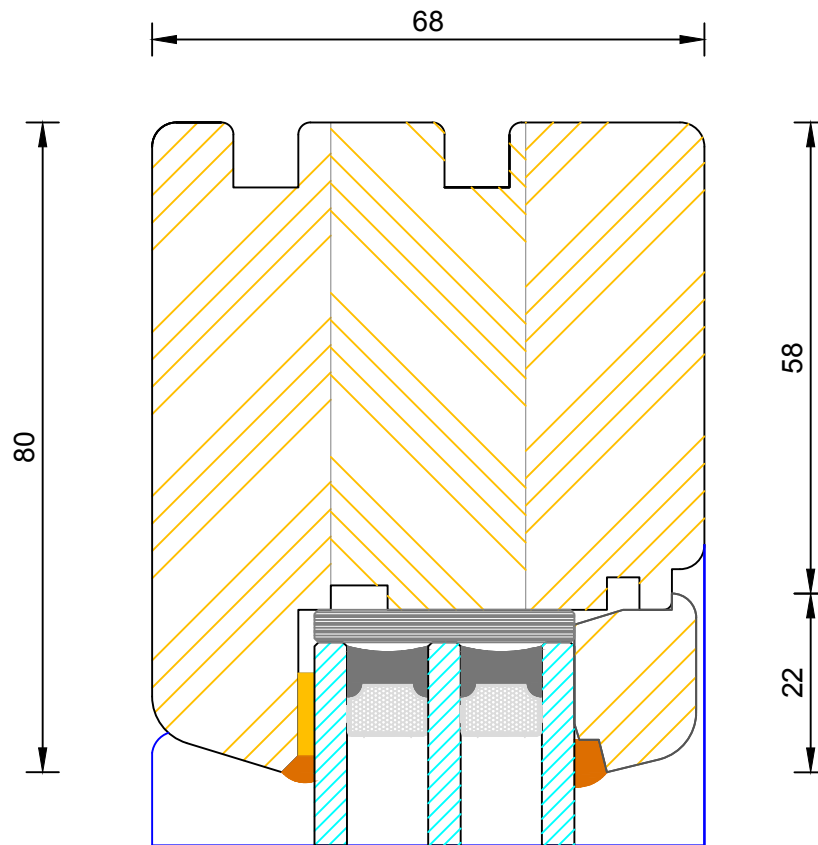

**Contemporary Open In Lipped French Door
Triple Glazed - Fanlight Head**

DIMENSIONS	PLOT SIZE	SCALE	DATE	REV	DWG NO.
MM	A4	1:1	22.11.2010	A	1343
Please consider the environment before printing					

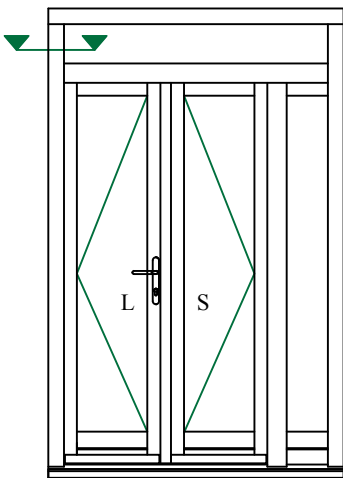
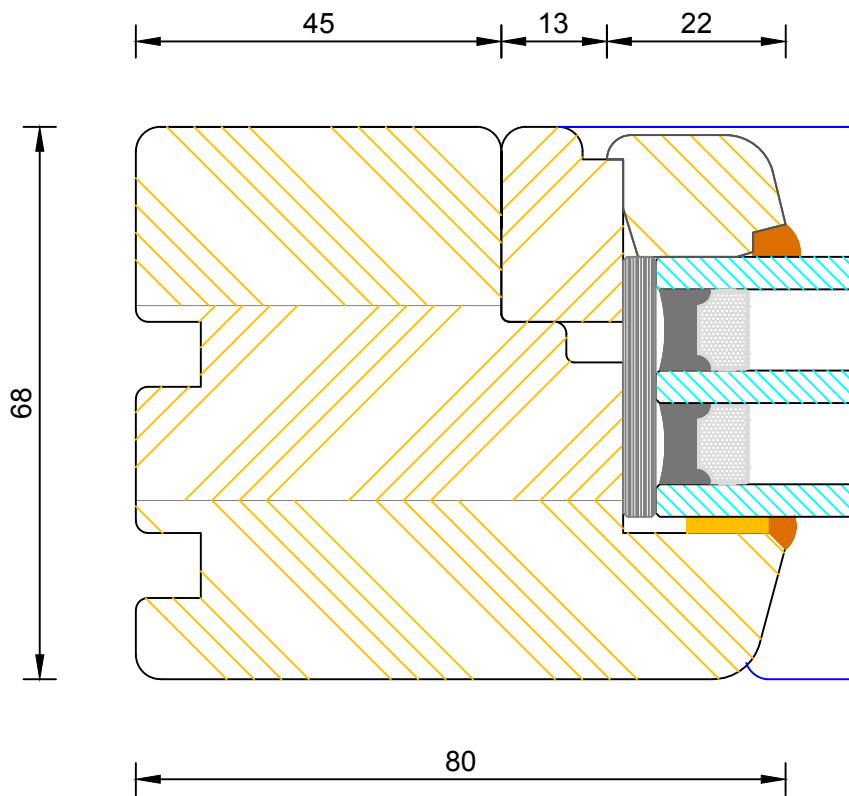

**Contemporary Open In Lipped French Door
Triple Glazed - Fanlight Jamb**

DIMENSIONS	PLOT SIZE	SCALE	DATE	REV	DWG NO.
MM	A4	1:1	22.11.2010	A	1344

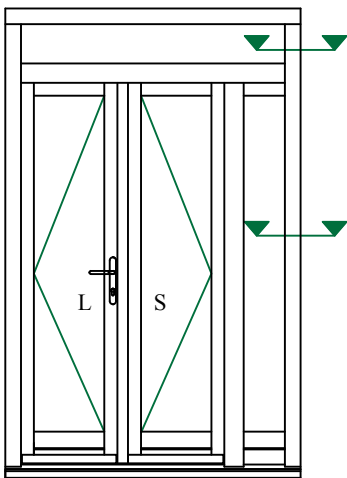
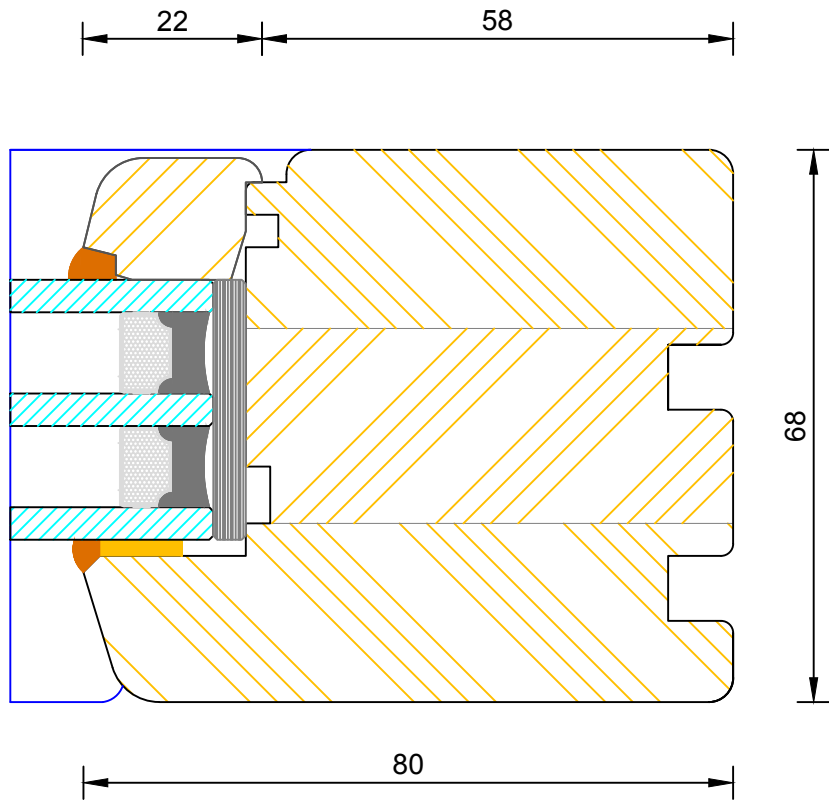

Contemporary Open In Lipped French Door
Triple Glazed - Sidelight Jamb

DIMENSIONS	PLOT SIZE	SCALE	DATE	REV	DWG NO.
MM	A4	1:1	22.11.2010	A	1345

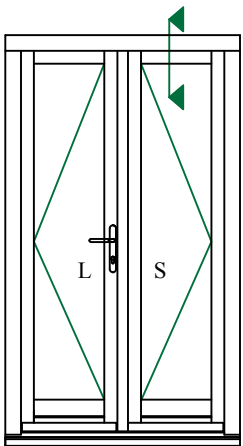
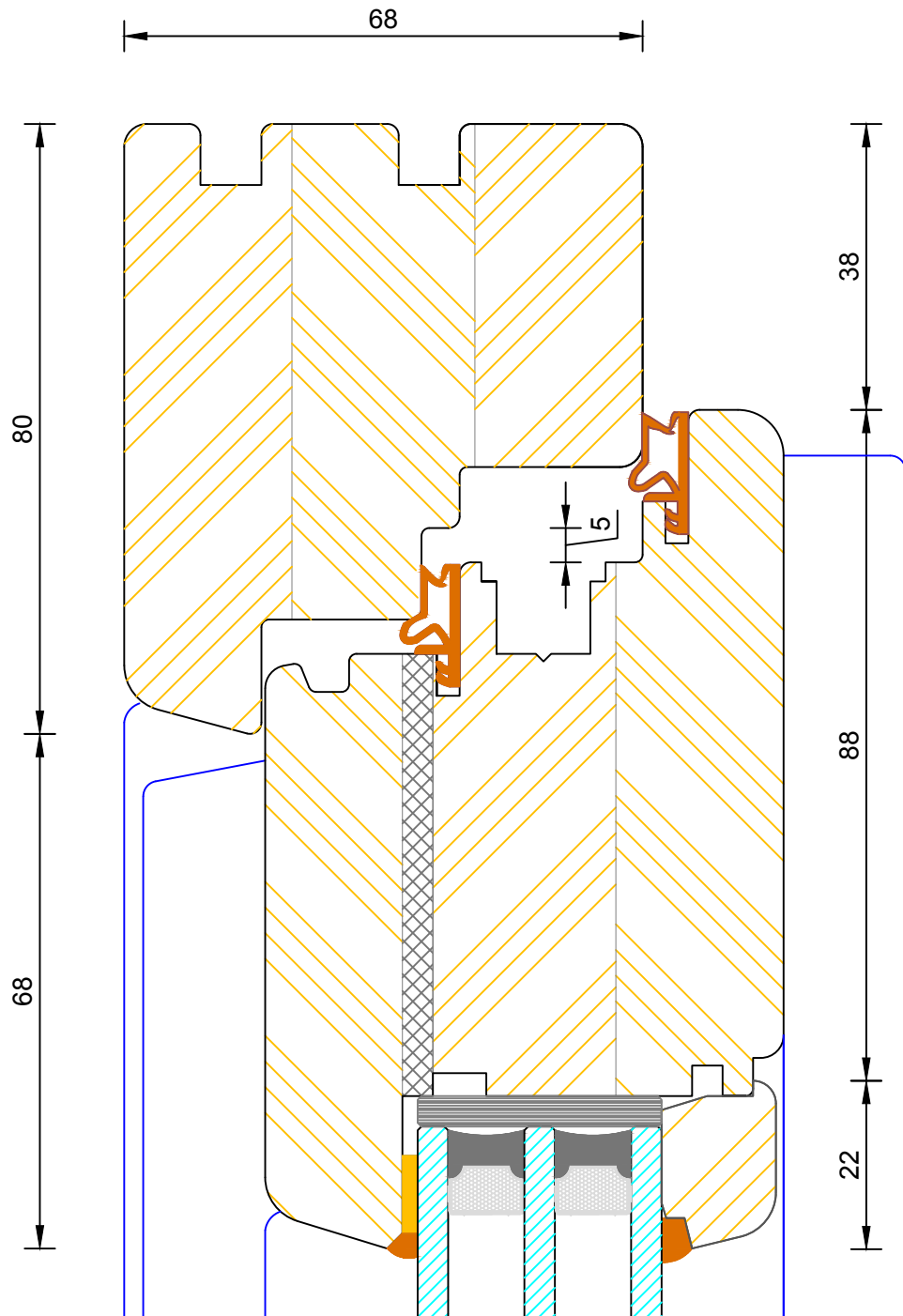

Contemporary Open In Lipped French Door
 Triple Glazed - Frame & Leaf Head (Without Vent)

DIMENSIONS	PLOT SIZE	SCALE	DATE	REV	DWG NO.
MM	A4	1:1	22.11.2010	A	1346

Please consider the environment before printing

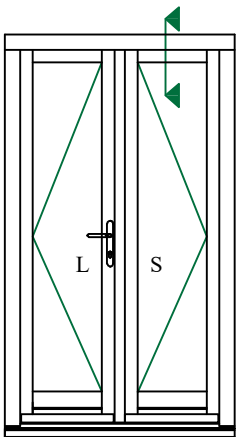
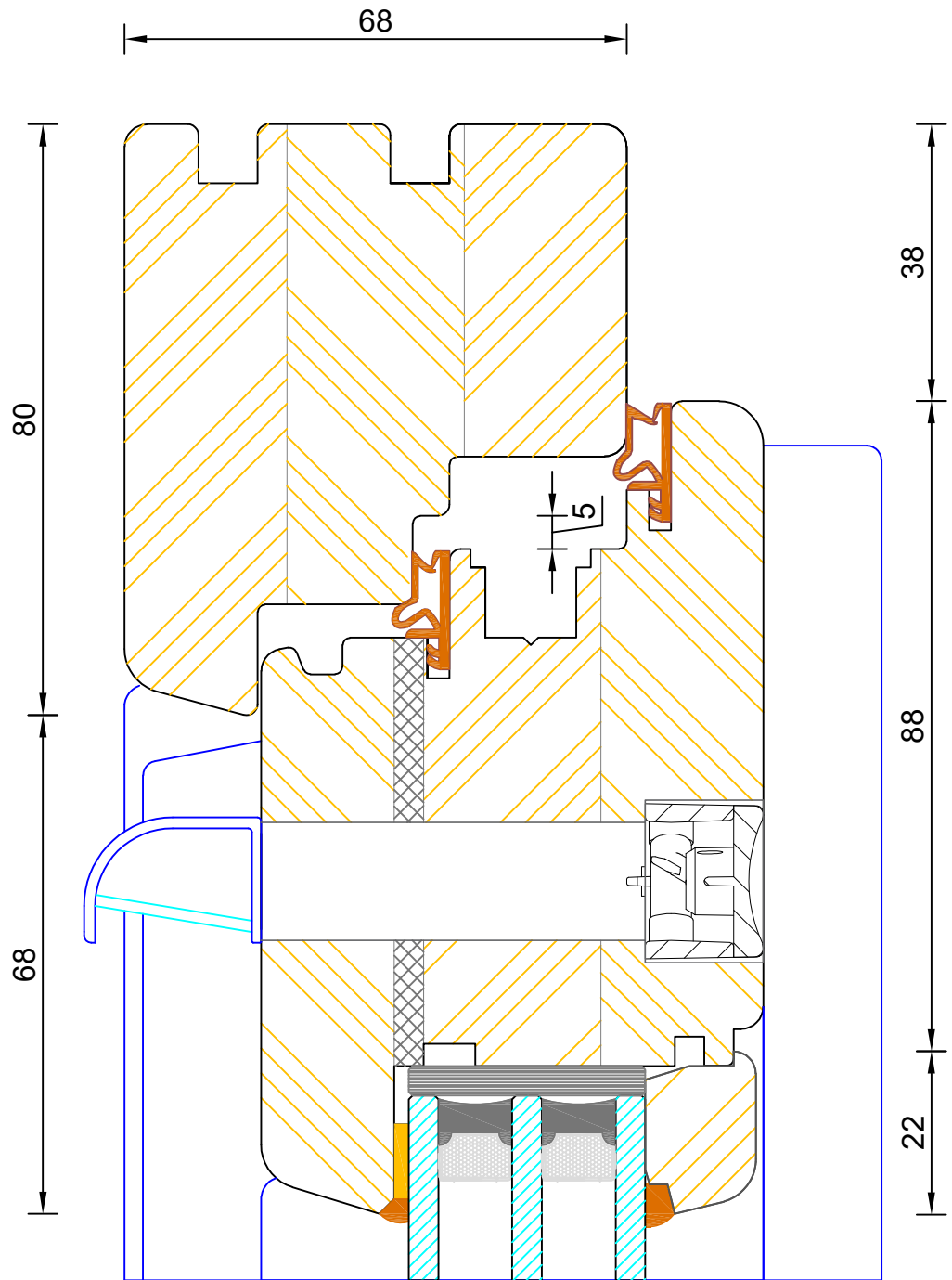

**Contemporary Open In Lipped French Door
Triple Glazed - Fane & Leaf (With Vent)**

DIMENSIONS	PLOT SIZE	SCALE	DATE	REV	DWG NO.
MM	A4	1:1	22.11.2010	A	1347
 Please consider the environment before printing					

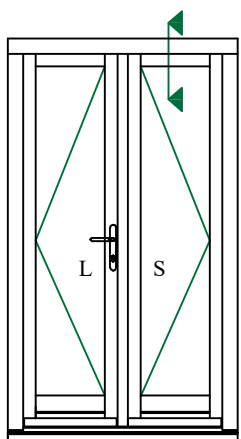
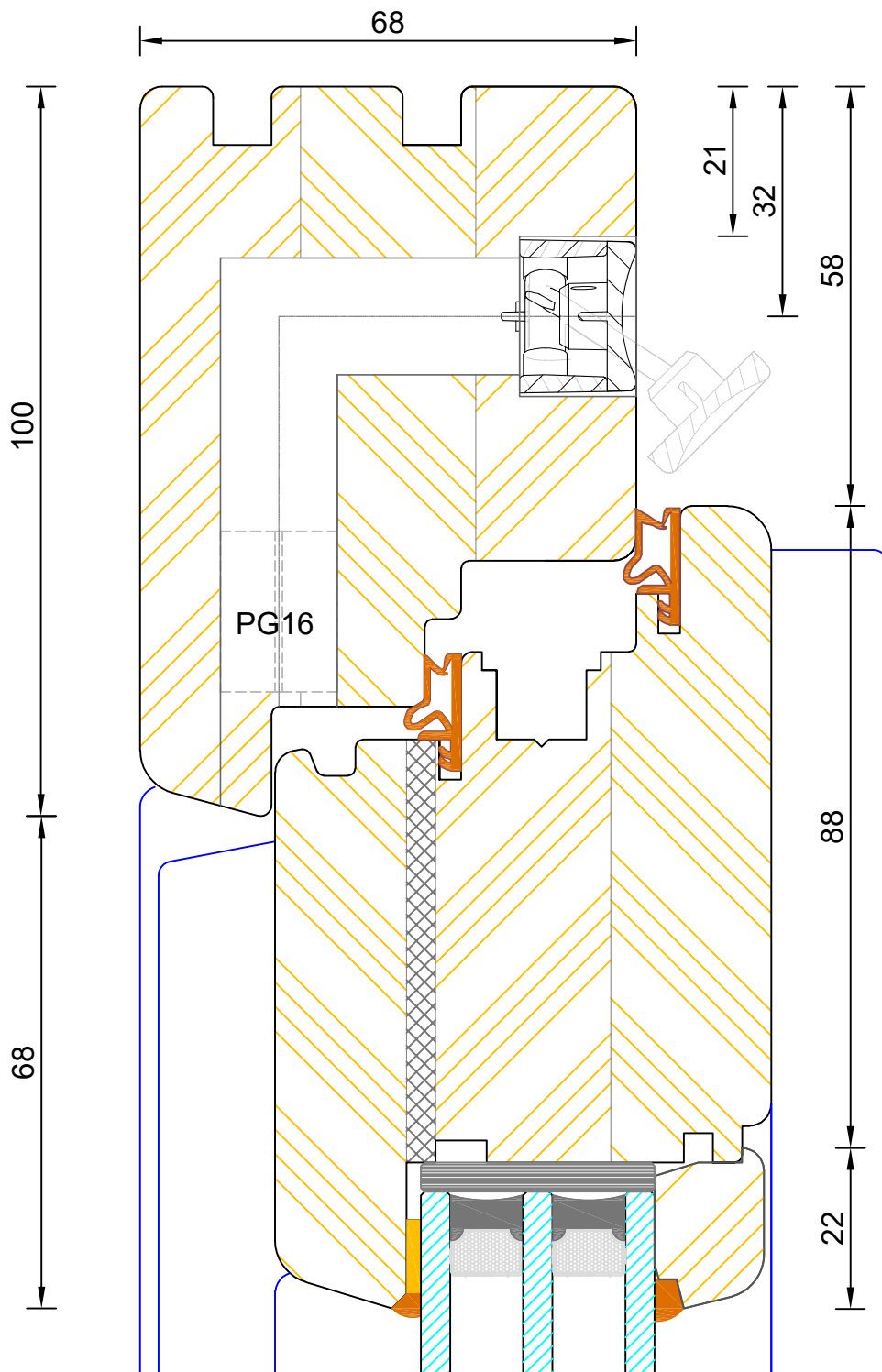

Contemporary Open In Lipped French Door
 Triple Glazed - Frame & Leaf (With Vent in Frame Head)

DIMENSIONS	PLOT SIZE	SCALE	DATE	REV	DWG NO.
MM	A4	1:1	04.07.2022	B	1347.1

Please consider the environment before printing

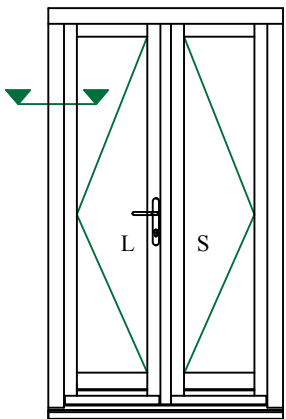
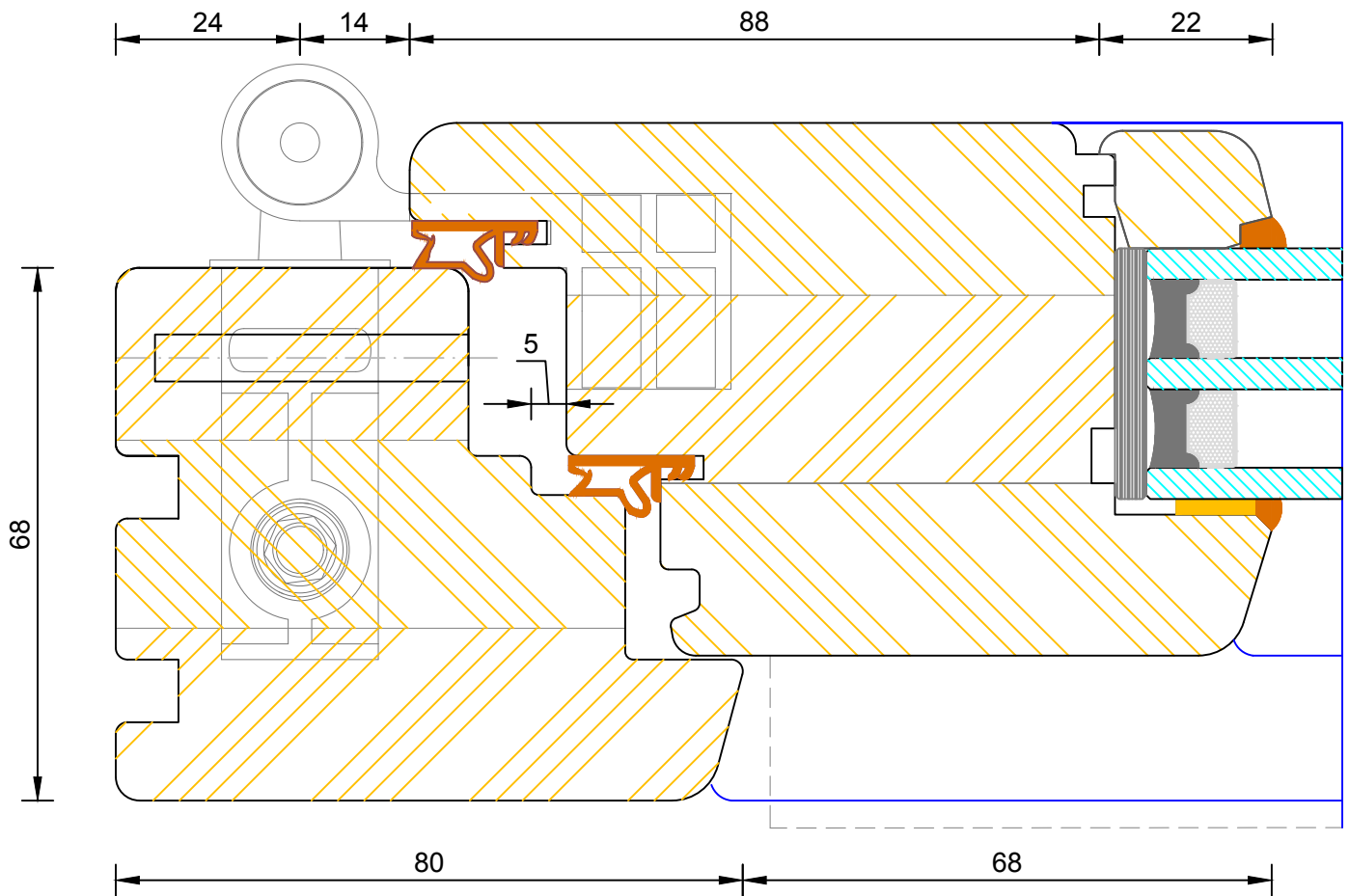

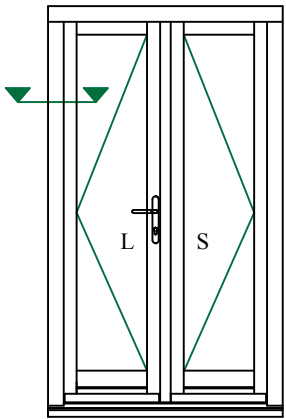
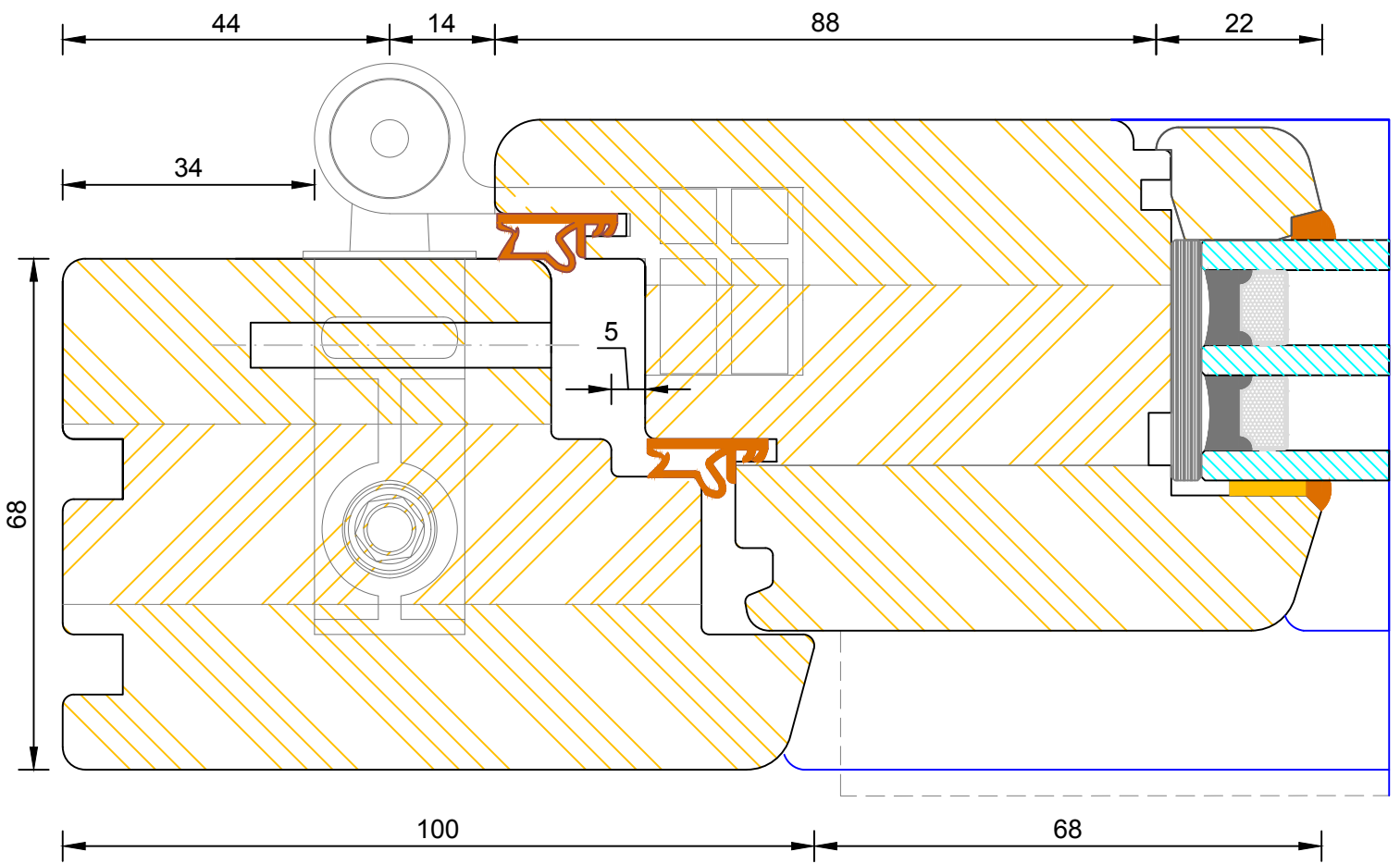

Contemporary Open In Lipped French Door
 Triple Glazed - Frame & Leaf Jamb (100mm)

DIMENSIONS	PLOT SIZE	SCALE	DATE	REV	DWG NO.
MM	A4	1:1	22.11.2010	A	1349

Please consider the environment before printing

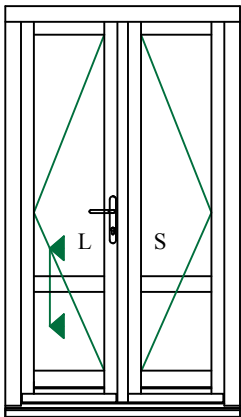
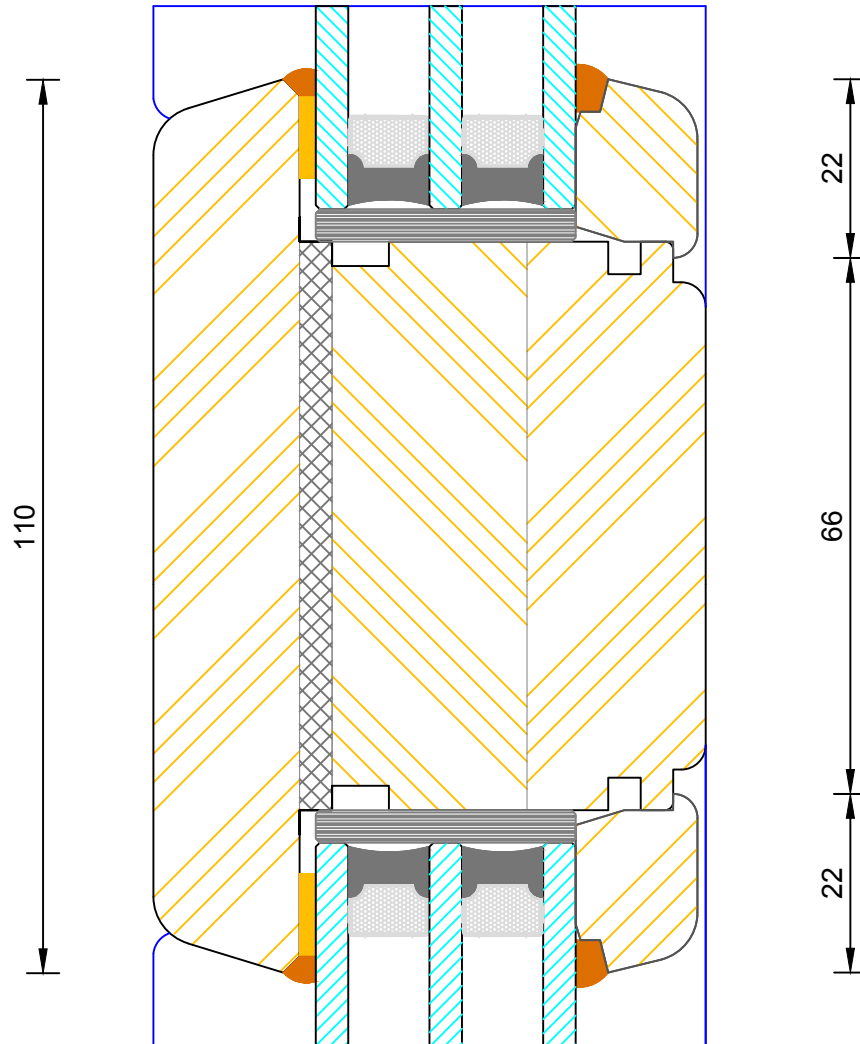

Contemporary Open In Lipped French Door
Triple Glazed - Mid Rail

DIMENSIONS	PLOT SIZE	SCALE	DATE	REV	DWG NO.
MM	A4	1:1	22.11.2010	A	1357

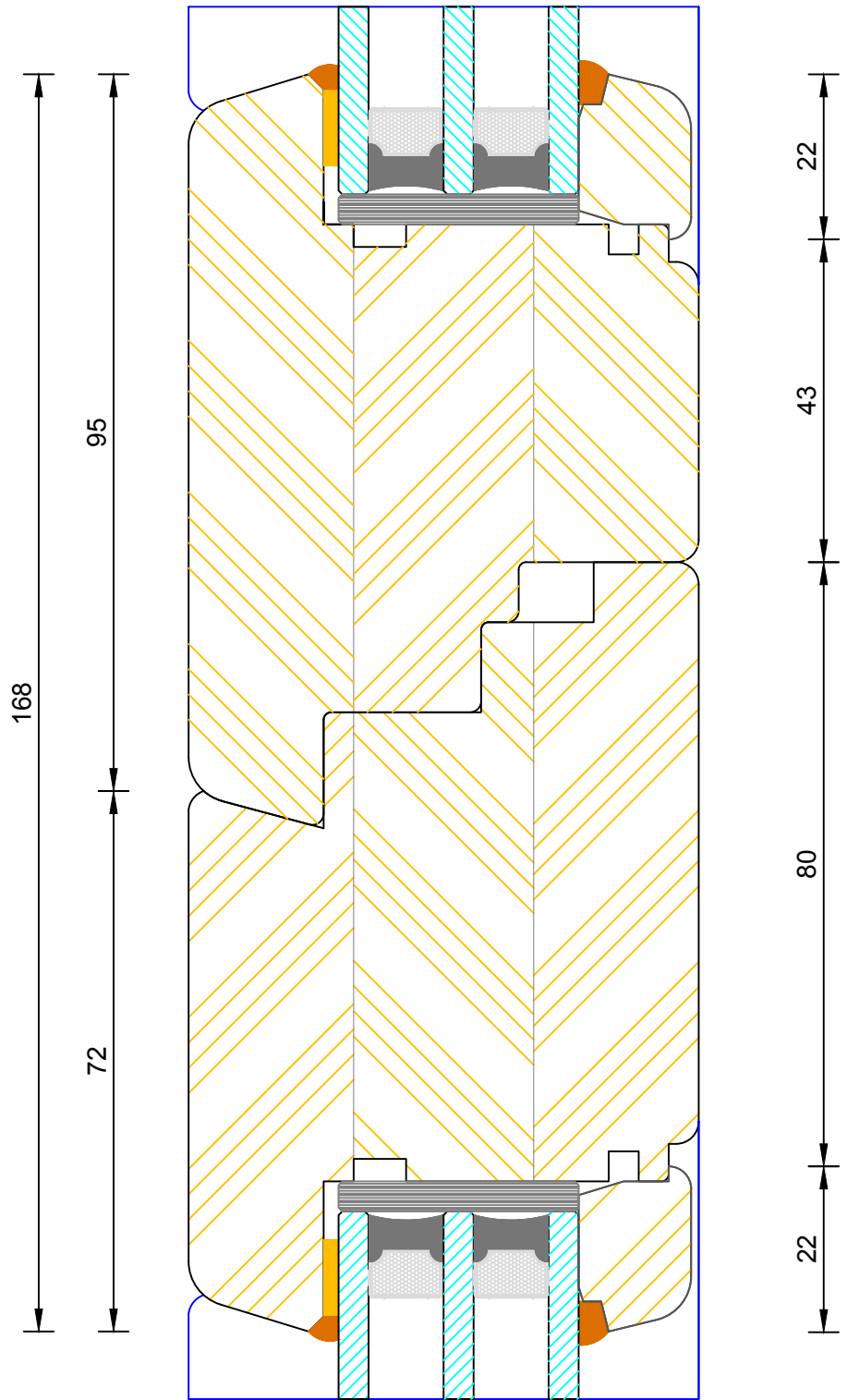
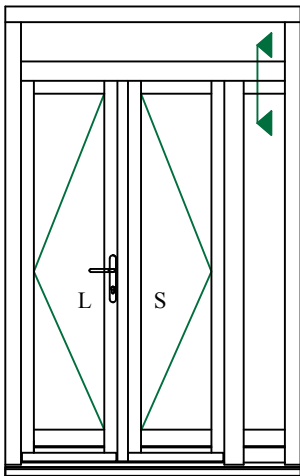

Contemporary Open In Lipped French Door
Triple Glazed - Fanlight / Sidelight Transom

DIMENSIONS	PLOT SIZE	SCALE	DATE	REV	DWG NO.
MM	A4	1:1	22.11.2010	A	1358

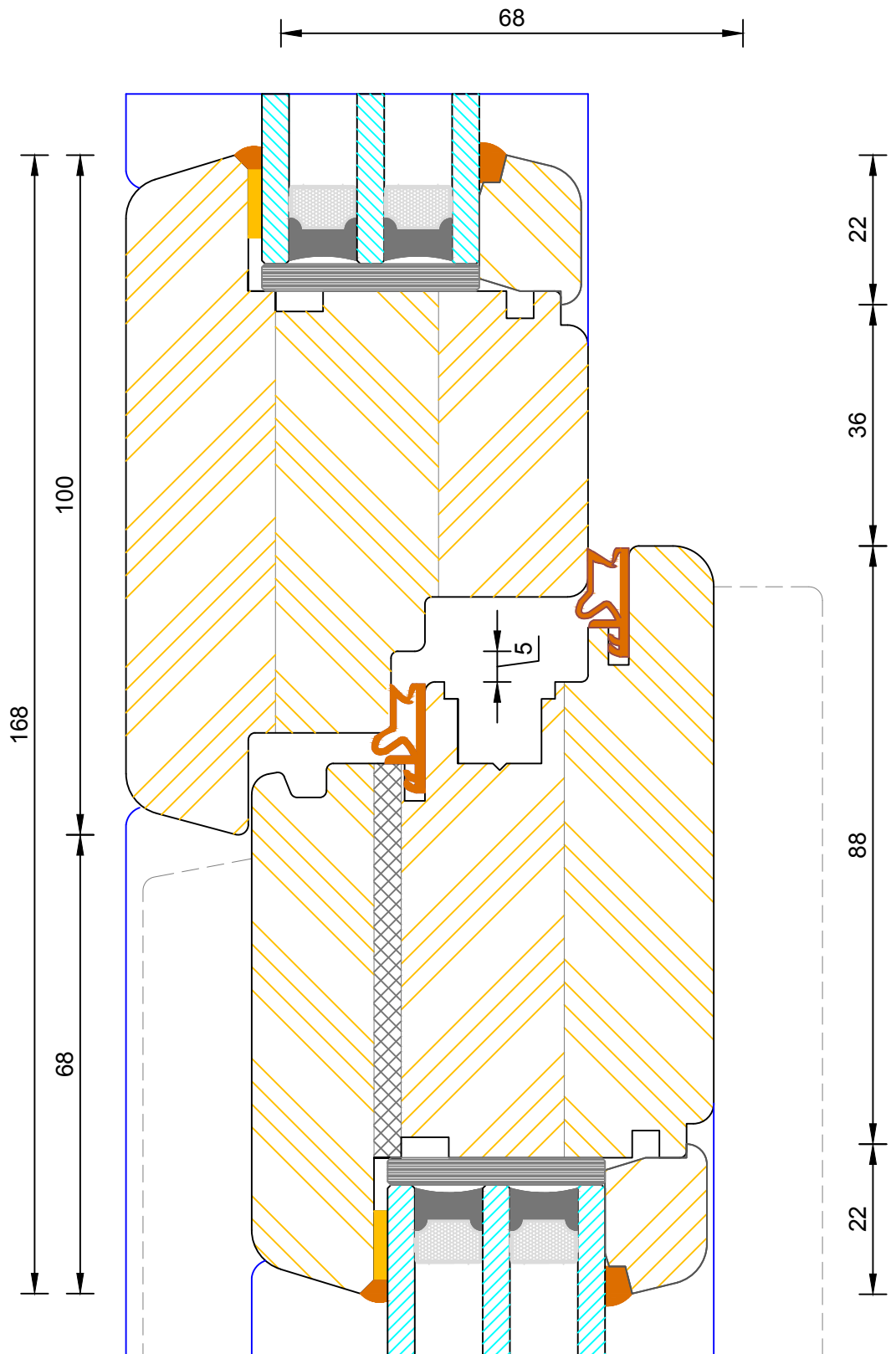
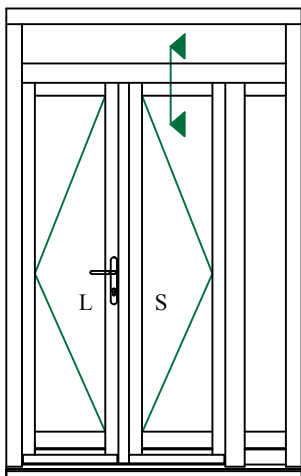

Contemporary Open In Lipped French Door
Triple Glazed - Fanlight Transom (Leaf Without Vent)

DIMENSIONS	PLOT SIZE	SCALE	DATE	REV	DWG NO.
MM	A4	1:1	22.11.2010	A	1359

Please consider the environment before printing

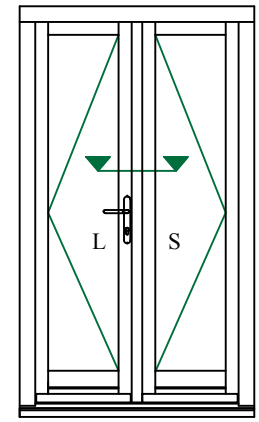
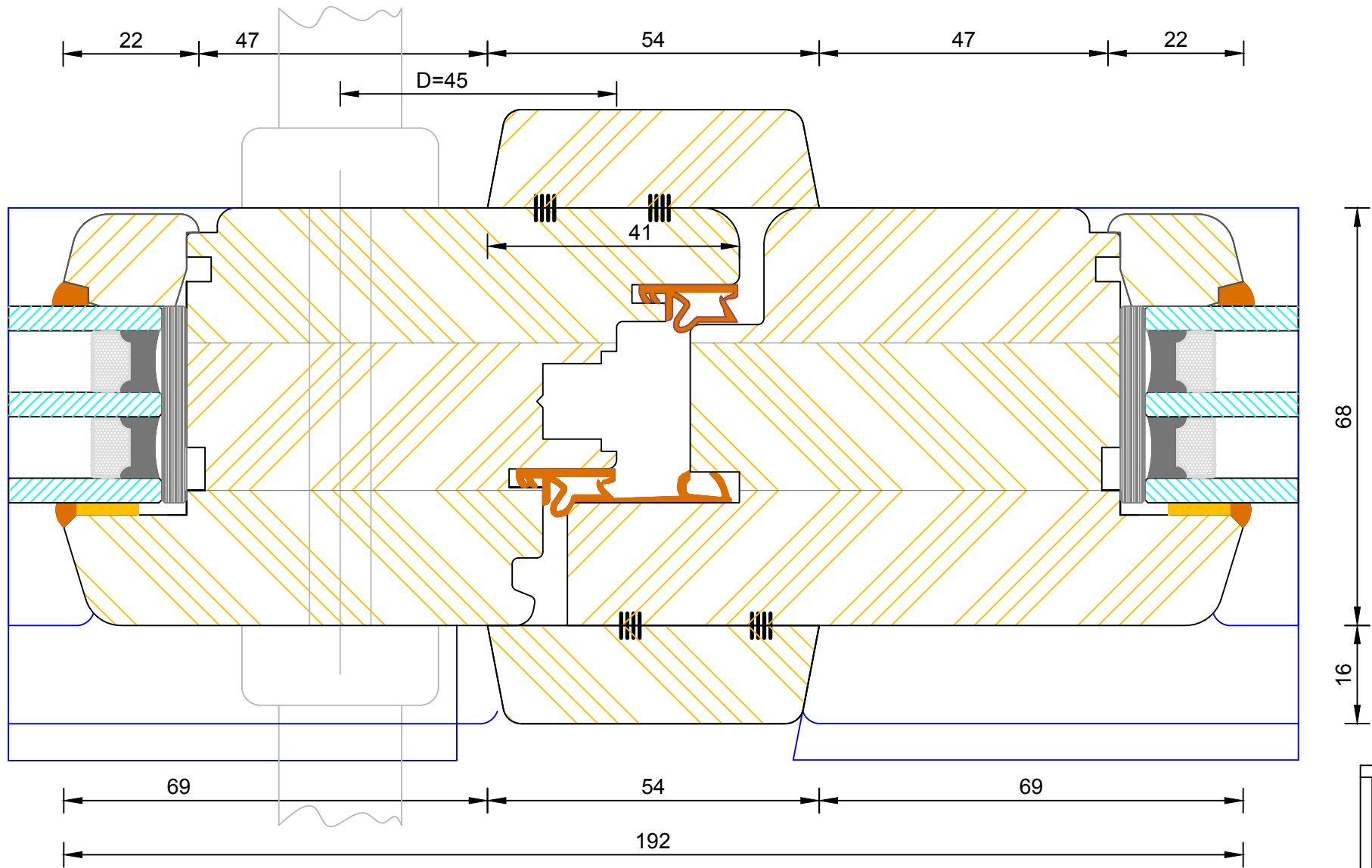

Contemporary Open In Lipped French Door
 Triple Glazed - Flying Mullion (Single Handle)

DIMENSIONS	PLOT SIZE	SCALE	DATE	REV	DWG NO.
MM	A4	1:1	22.11.2010	A	1361
Please consider the environment before printing					

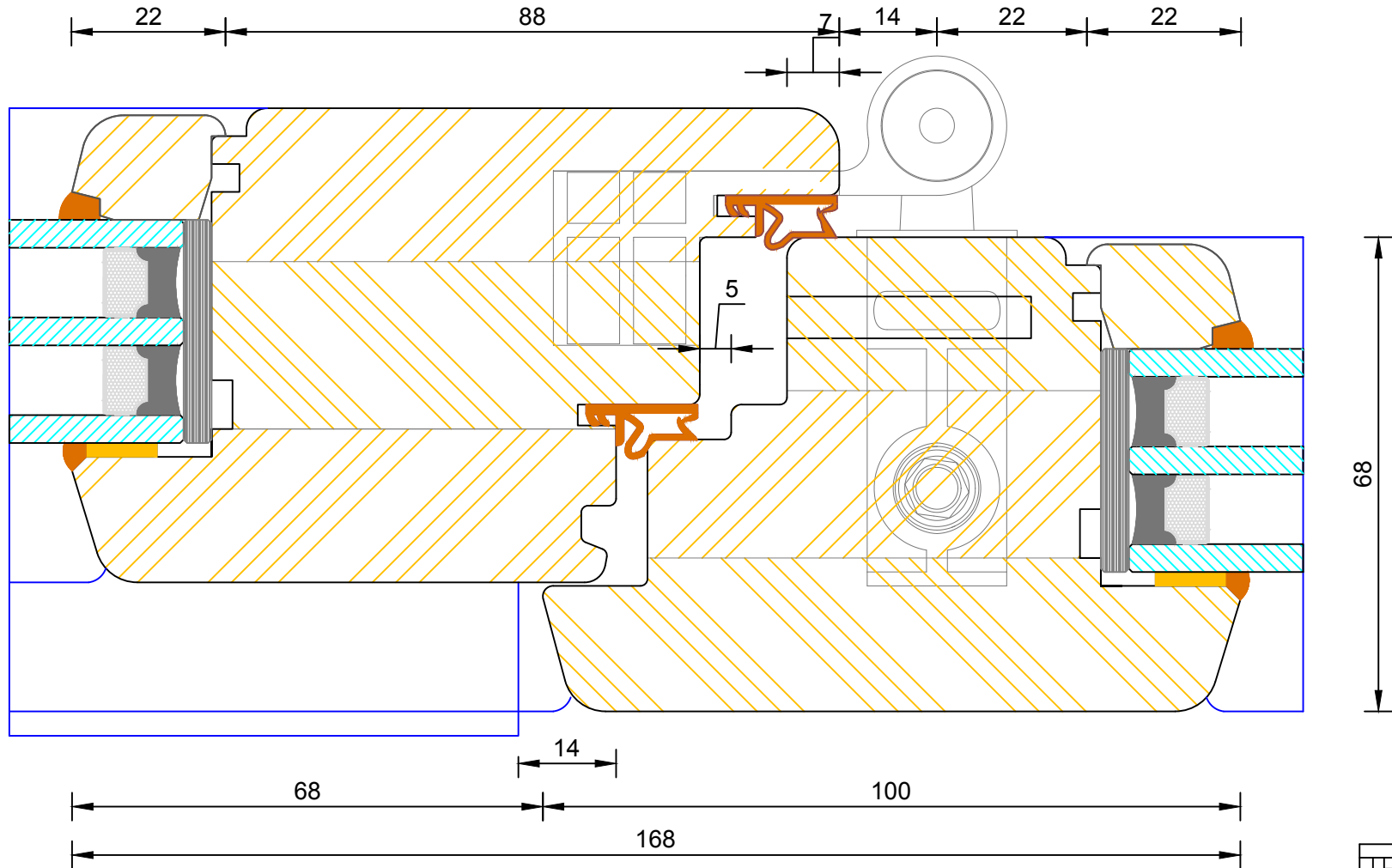

68

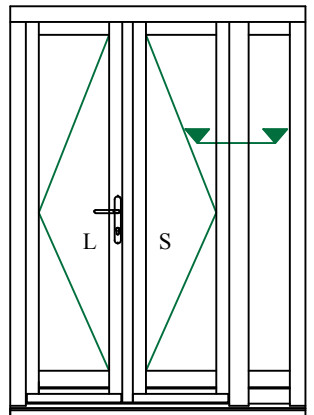

Contemporary Open In Lipped French Door
Triple Glazed - Solid Mullion

DIMENSIONS	PLOT SIZE	SCALE	DATE	REV	DWG NO.
MM	A4	1:1	22.11.2010	A	1362
Please consider the environment before printing					

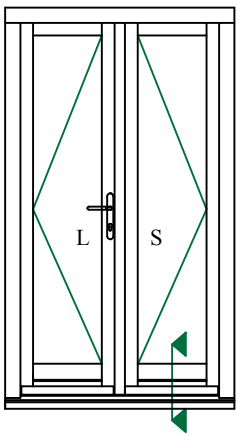
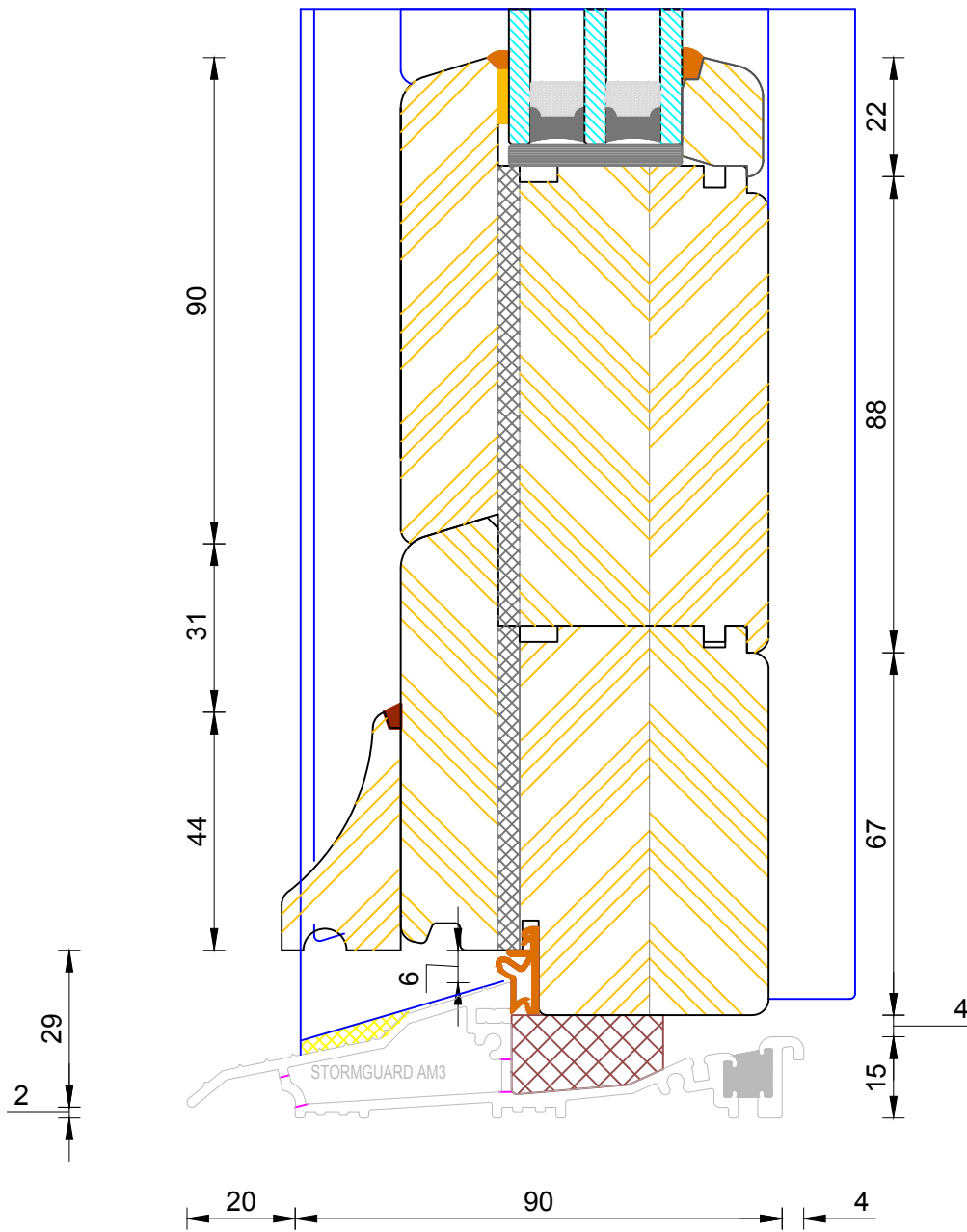

Contemporary Open In Lipped French Door Triple Glazed - Mobility Thresh

DIMENSIONS	PLOT SIZE	SCALE	DATE	REV	DWG NO.
MM	A3	1:1	22.11.2010	A	1353

Please consider the environment before printing

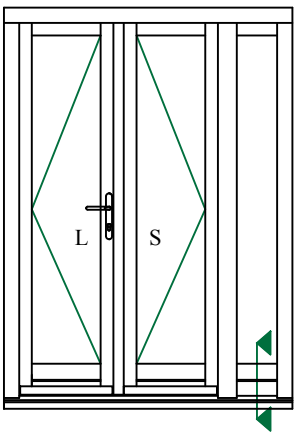
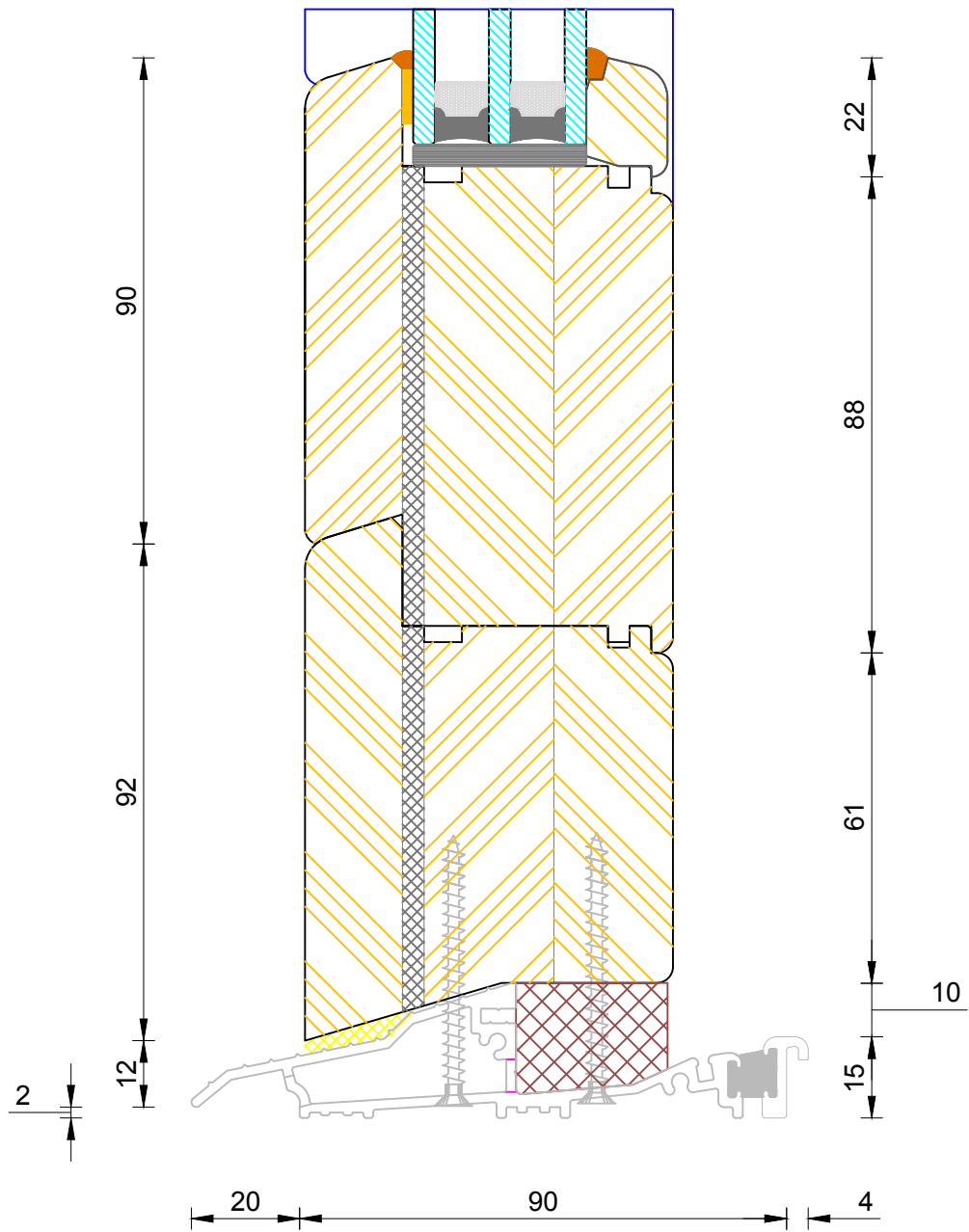

Contemporary Open In Lipped French Door
Triple Glazed - Mobility Thresh (Sidelight)

DIMENSIONS	PLOT SIZE	SCALE	DATE	REV	DWG NO.
MM	A3	1:1	22.11.2010	A	1356

Please consider the environment before printing

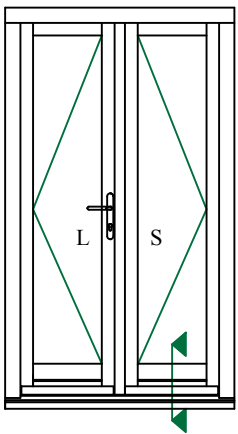
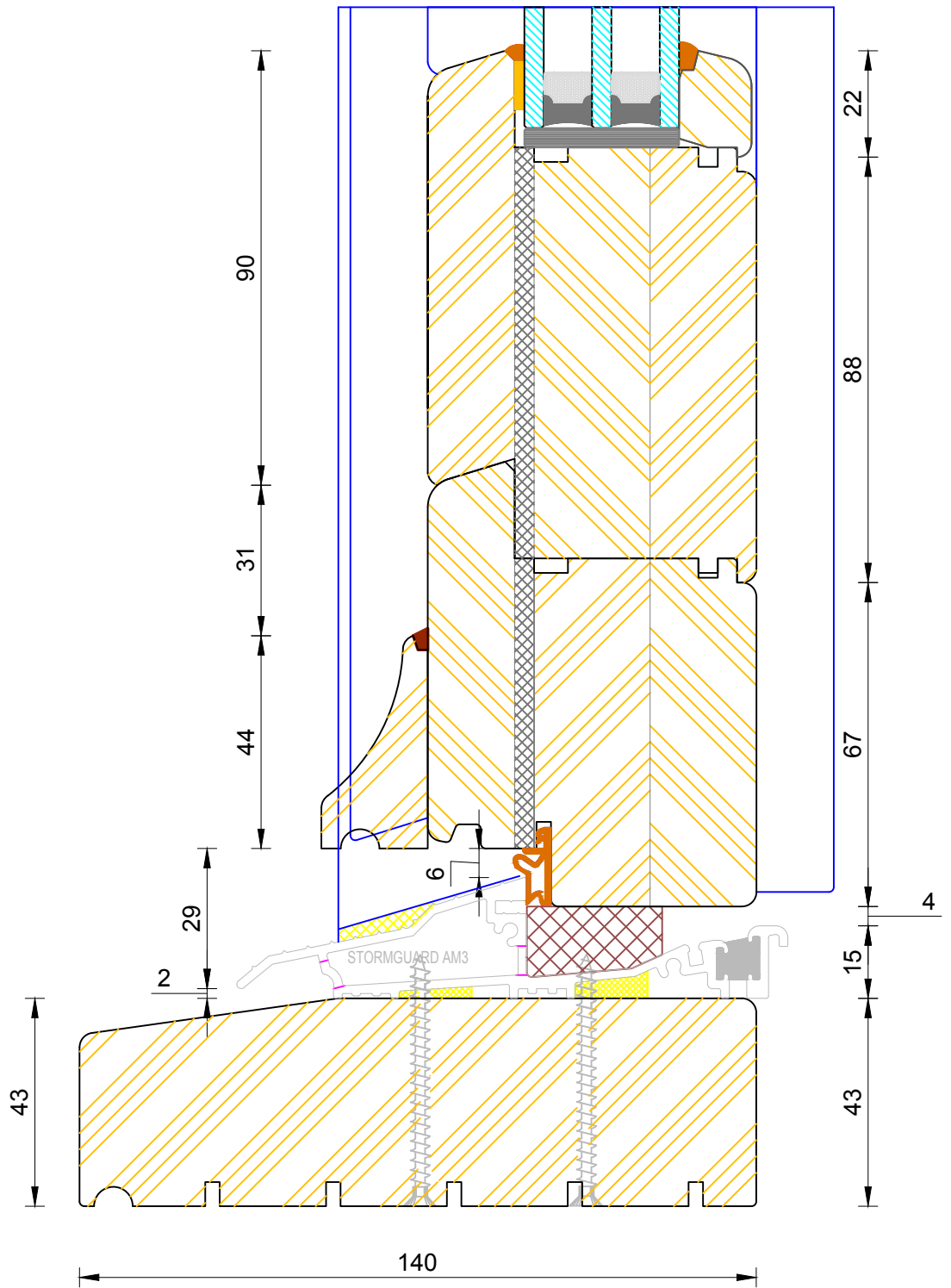

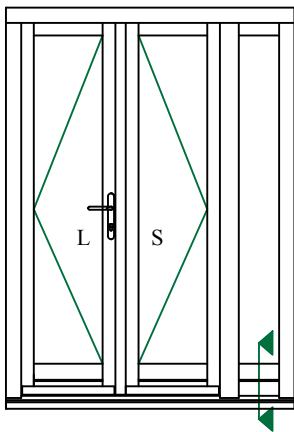
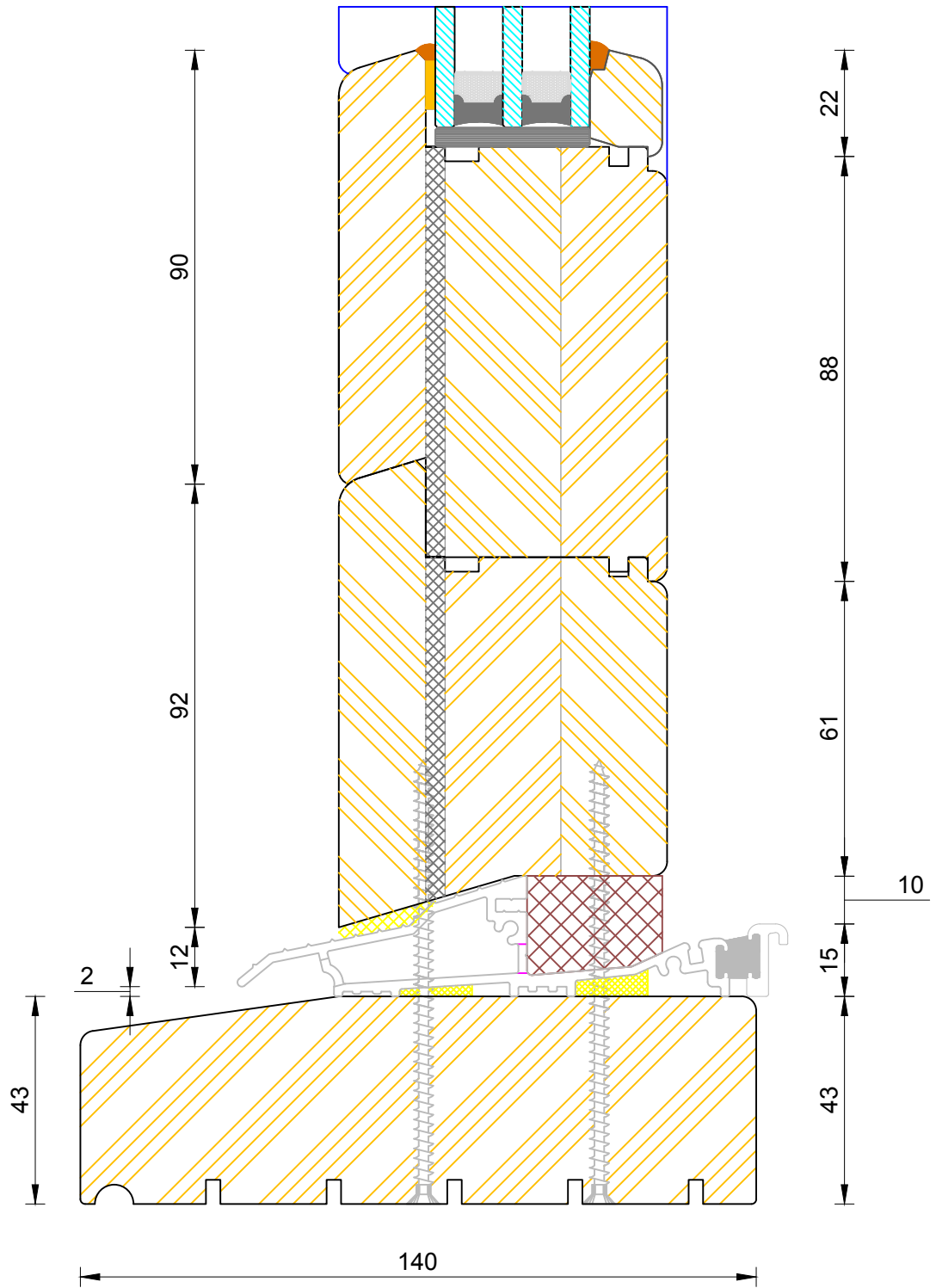

**Contemporary Open In Lipped French Door
Triple Glazed - Standard Thresh (Sidelight)**

DIMENSIONS	PLOT SIZE	SCALE	DATE	REV	DWG NO.
MM	A3	1:1	22.11.2010	A	1354

Please consider the environment before printing

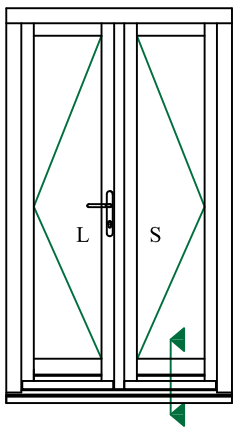
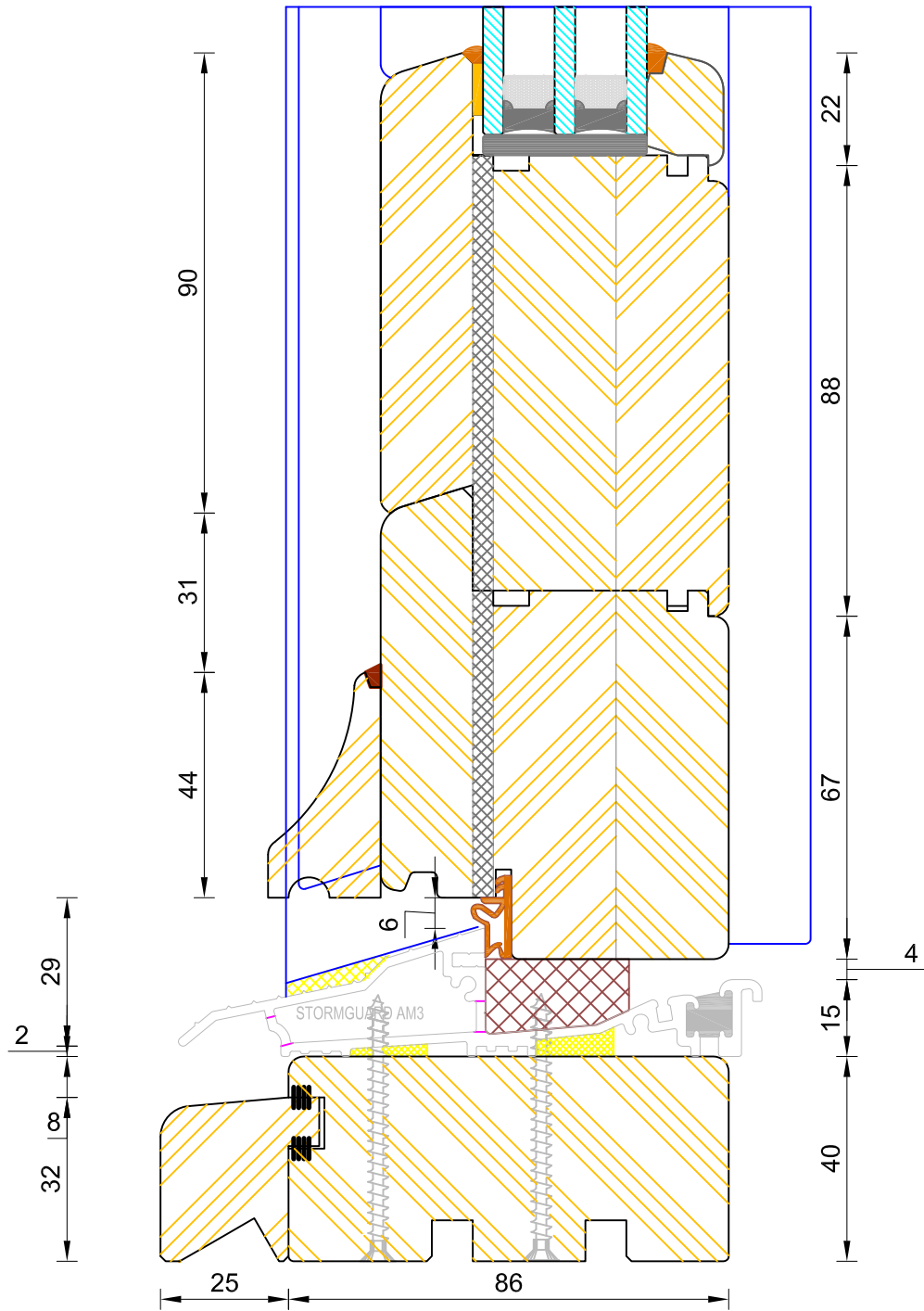

CILL EXTENSION - available options: 25mm (111mm o/a) / 47mm (133mm o/a) / 62mm (148mm o/a) / 87mm (173mm o/a) / 114mm (200mm o/a) / 125mm (211mm o/a) / 140mm (223mm o/a)

NOTE: Cill Extensions should be supported from underneath; the maximum overhang over Brick / Blockwork for cill extension should not exceed 25mm in order to avoid damage when stepped on. Warranties are invalidated when fitted with overhang in excess to that.

If not otherwise stated, Hardwood Threshold will be painted the same colour as Frame.

Contemporary Open In Lipped French Door Triple Glazed - Coupling Thresh

DIMENSIONS	PLOT SIZE	SCALE	DATE	REV	DWG NO.
MM	A3	1:1	22.11.2010	A	1352

Please consider the environment before printing

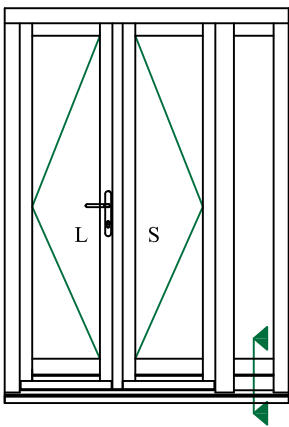
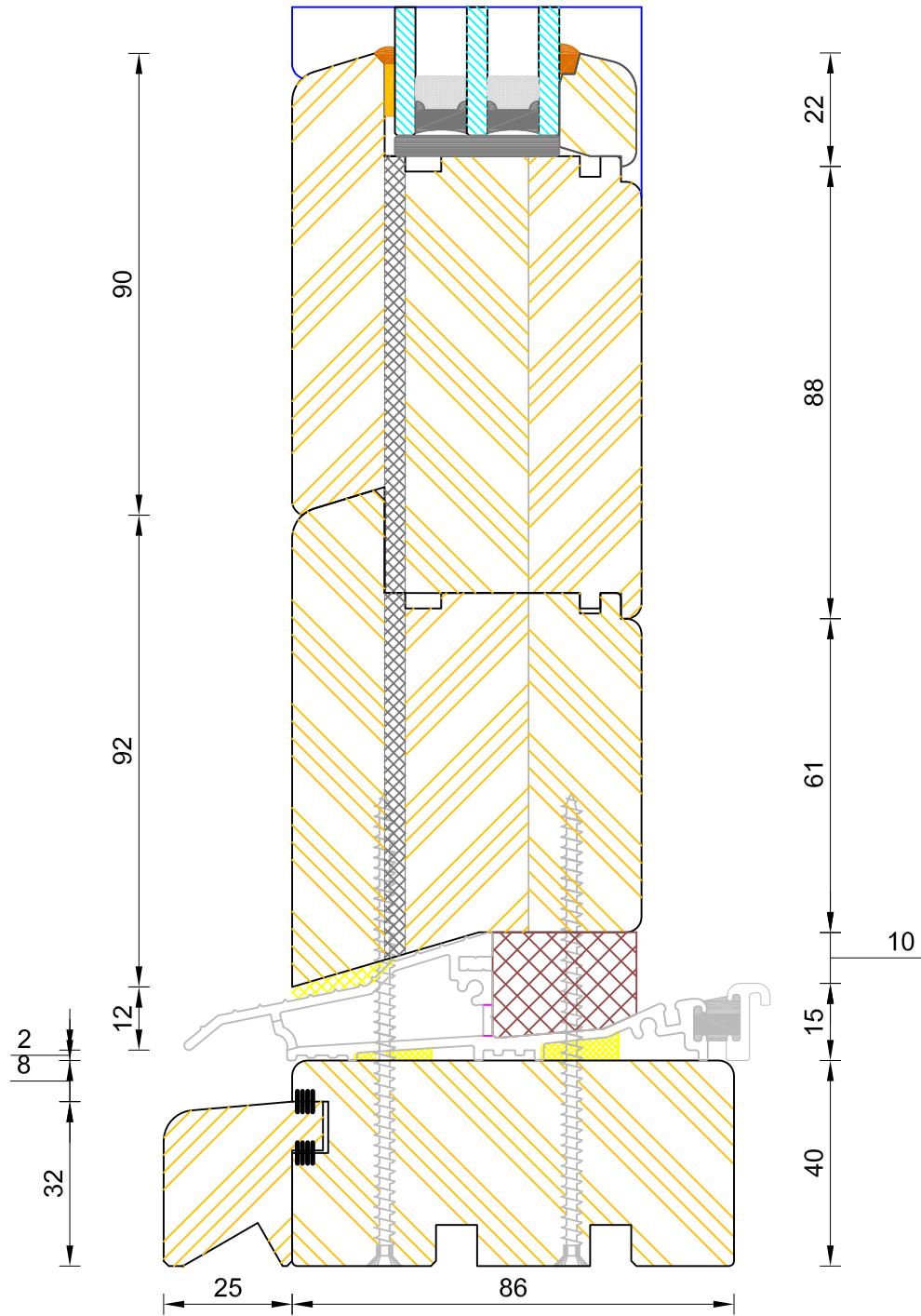

CILL EXTENSION - available options: 25mm (111mm o/a) / 47mm (133mm o/a) / 62mm (148mm o/a) / 87mm (173mm o/a) / 114mm (200mm o/a) / 125mm (211mm o/a) / 140mm (223mm o/a)

NOTE: Cill Extensions should be supported from underneath; the maximum overhang over Brick / Blockwork for cill extension should not exceed 25mm in order to avoid damage when stepped on. Warranties are invalidated when fitted with overhang in excess to that.

If not otherwise stated, Hardwood Threshold will be painted the same colour as Frame.