

Contemporary HS Sliding Patio Door
Triple Glazed - Cill Extension Options

DIMENSIONS	PLOT SIZE	SCALE	DATE	REV	DWG NO.
MM	A4	1:1	25.09.2019	B	1401

Please consider the environment before printing

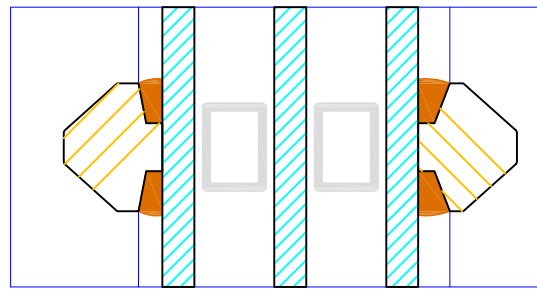

16

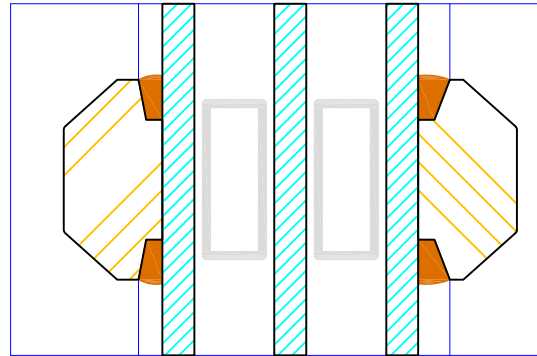

25

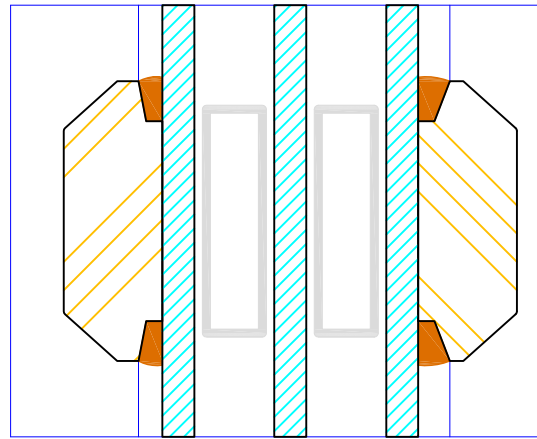

35

60 (varies min 60 / max 110mm)

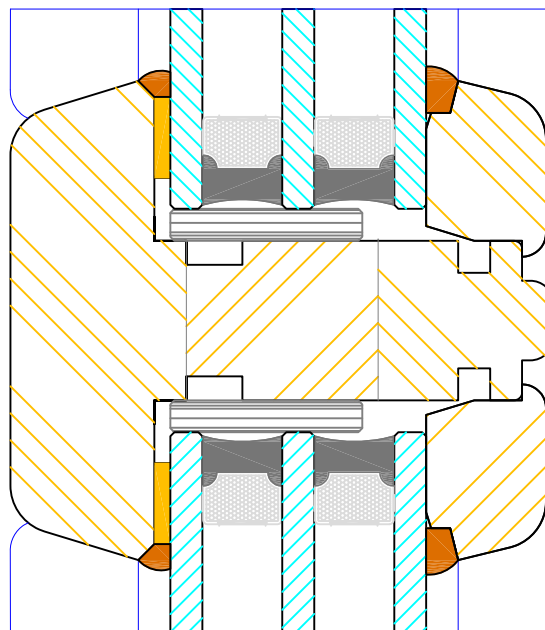

22
16
22

68

Contemporary HS Sliding Patio Door Triple Glazed - Bar Options

DIMENSIONS	PLOT SIZE	SCALE	DATE	REV	DWG NO.
MM	A4	1:1	15.05.2014	A	1402

Please consider the environment before printing

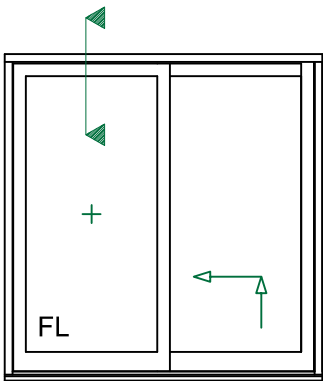
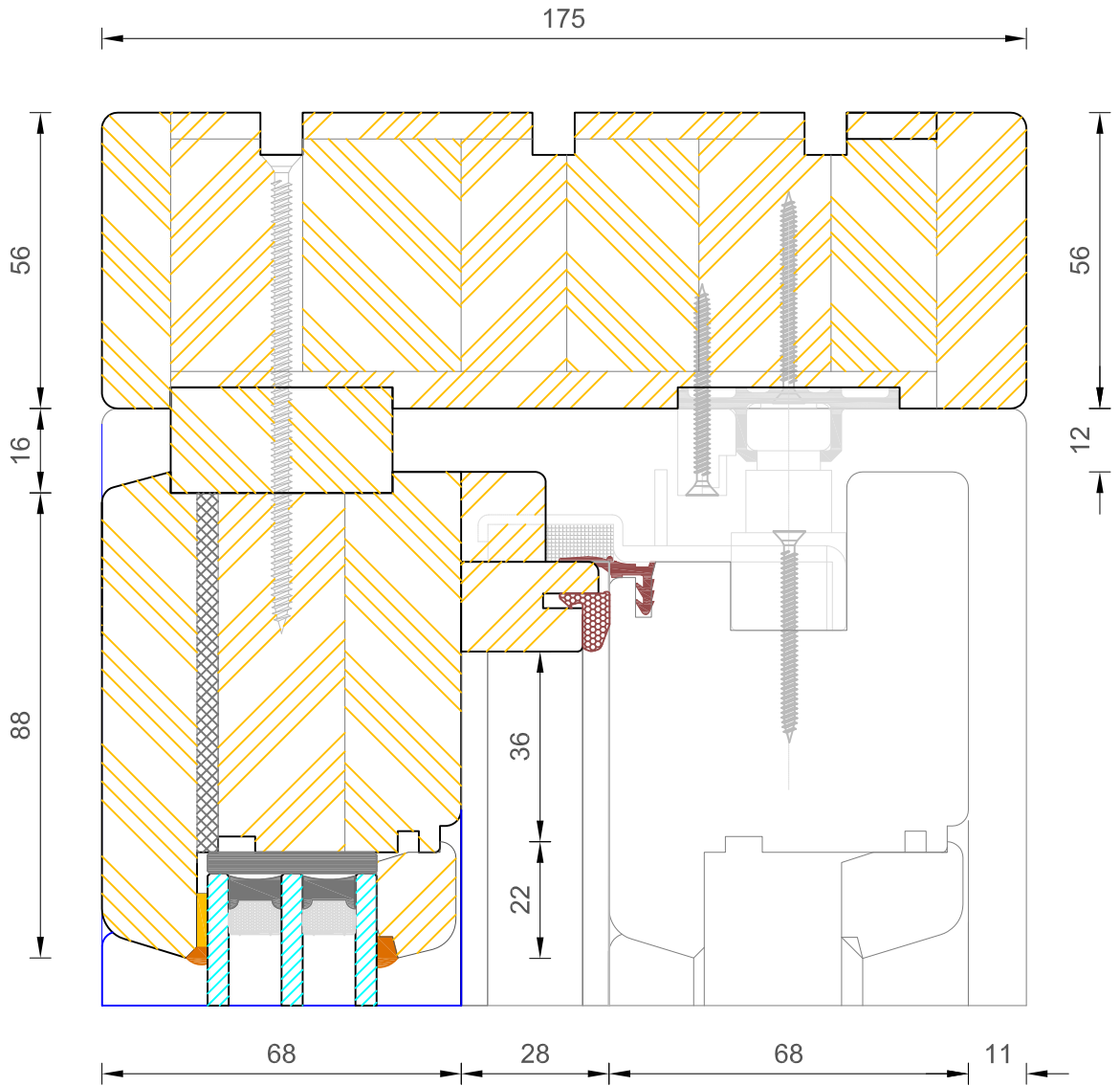

Contemporary HS Sliding Patio Door
 Triple Glazed - Frame Head Fixed Leaf (Without Vent)

DIMENSIONS	PLOT SIZE	SCALE	DATE	REV	DWG NO.
MM	A3	1:1	11.10.2018	B	1434

Please consider the environment before printing

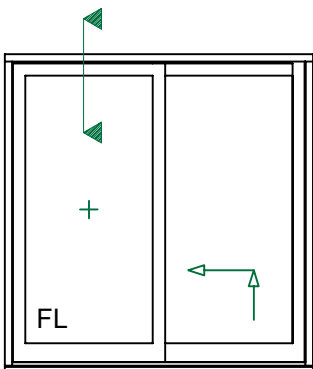
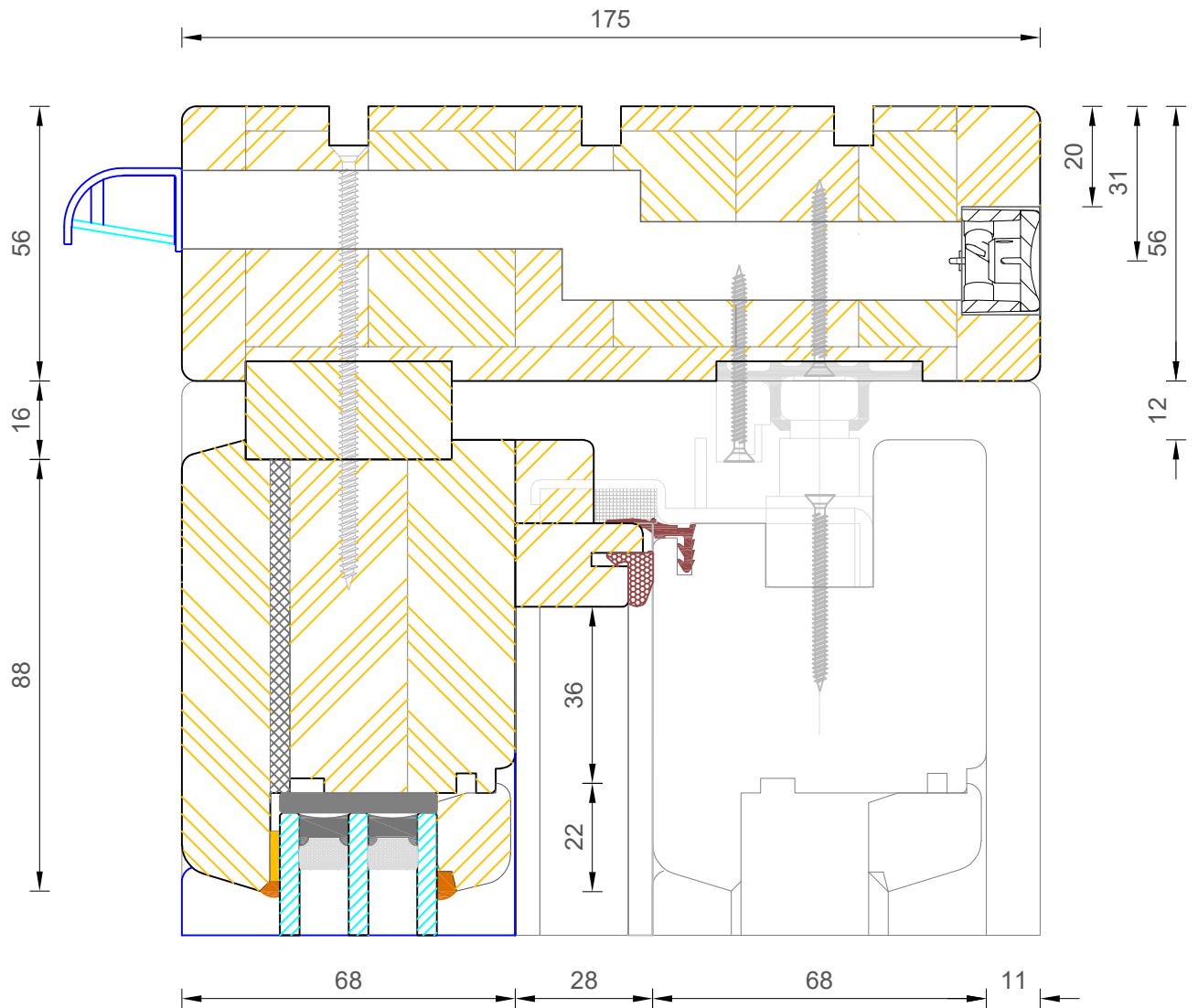

Contemporary HS Sliding Patio Door
 Triple Glazed - Frame Head Fixed Leaf (With Vent)

DIMENSIONS	PLOT SIZE	SCALE	DATE	REV	DWG NO.
MM	A3	1:1	05.07.2022	C	1436
Please consider the environment before printing					

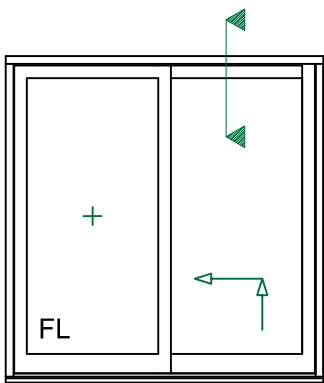
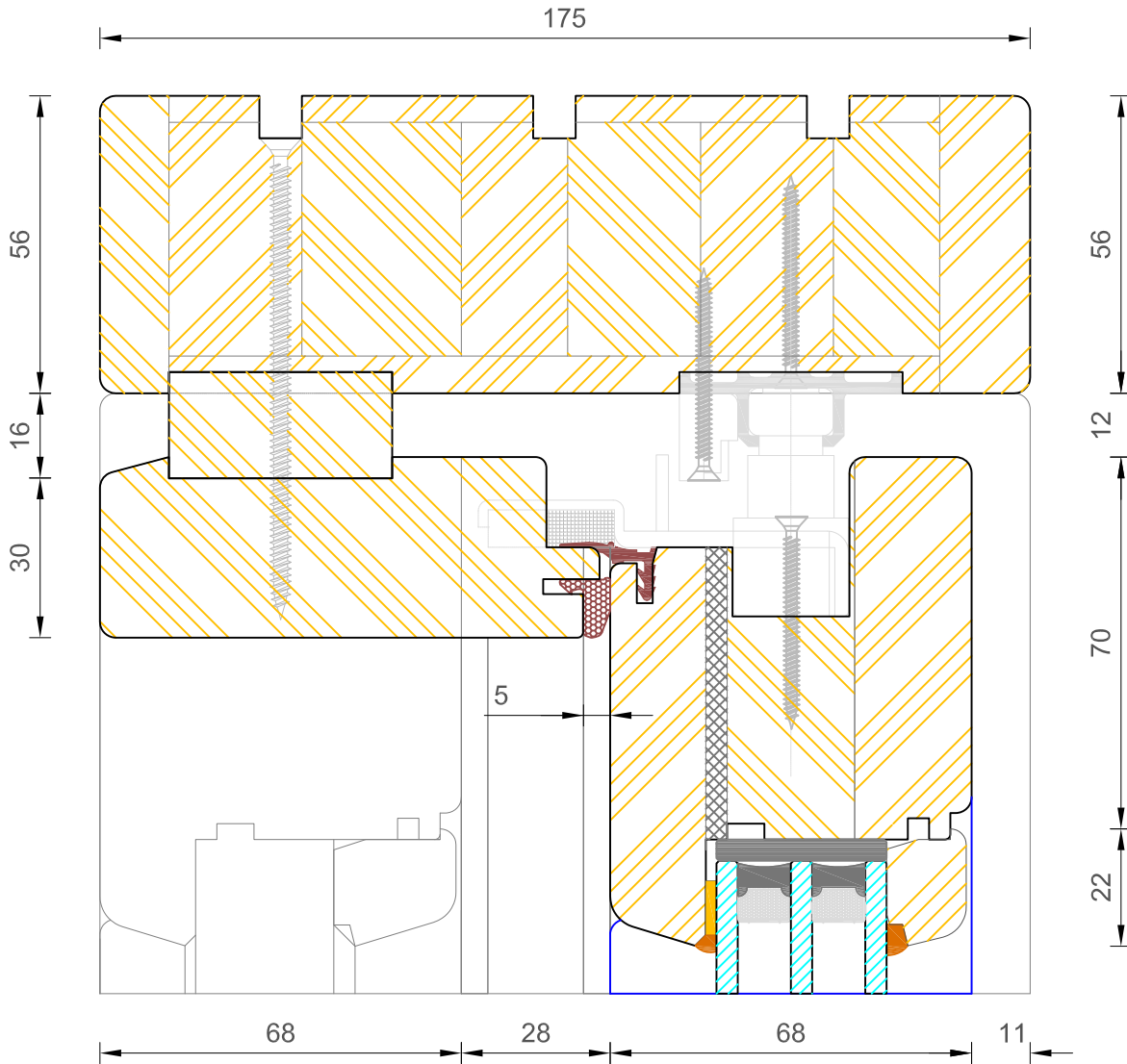

Contemporary HS Sliding Patio Door
Triple Glazed - Frame Head Opening Leaf

DIMENSIONS	PLOT SIZE	SCALE	DATE	REV	DWG NO.
MM	A3	1:1	11.10.2018	B	1435

Please consider the environment before printing

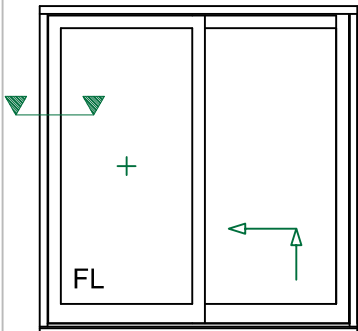
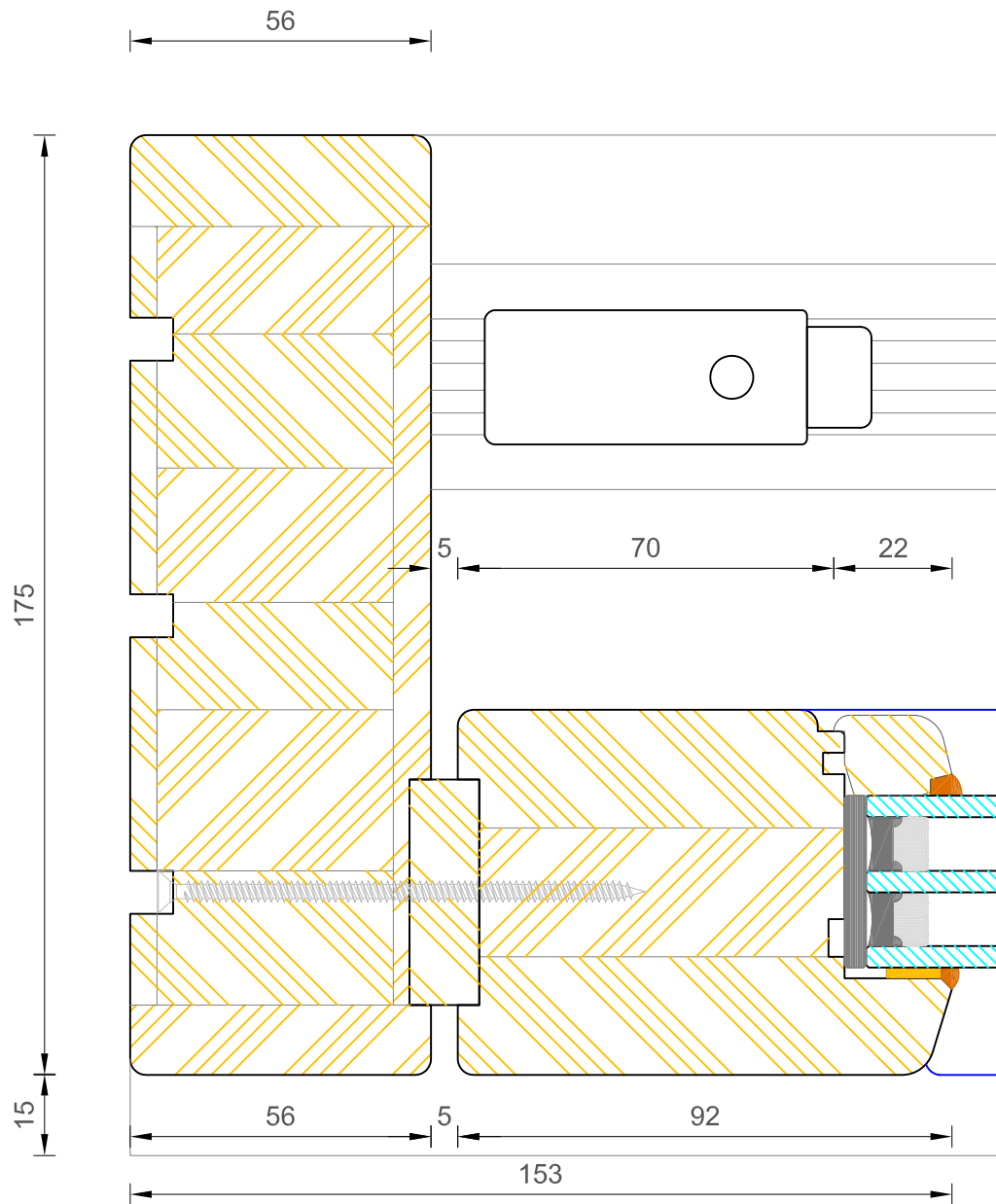

Contemporary HS Sliding Patio Door
Triple Glazed - Frame Jamb Fixed Leaf

DIMENSIONS	PLOT SIZE	SCALE	DATE	REV	DWG NO.
MM	A3	1:1	11.10.2018	B	1437

Please consider the environment before printing

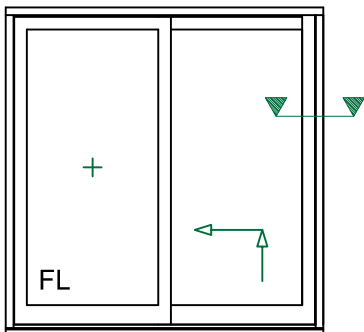
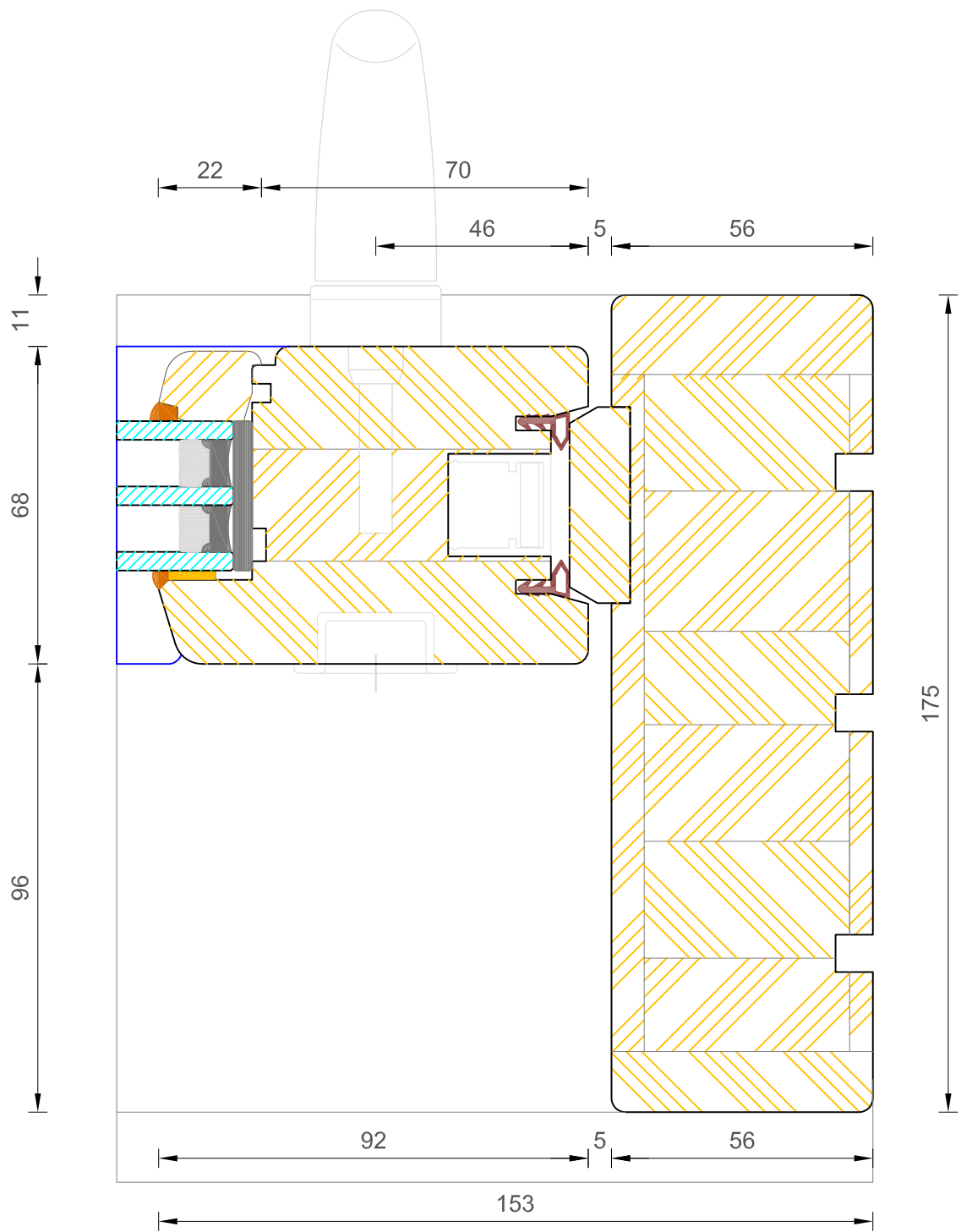

Contemporary HS Sliding Patio Door
Triple Glazed - Frame Jamb Opening Leaf

DIMENSIONS	PLOT SIZE	SCALE	DATE	REV	DWG NO.
MM	A3	1:1	11.10.2018	B	1438

Please consider the environment before printing

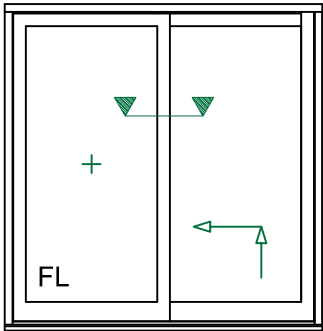
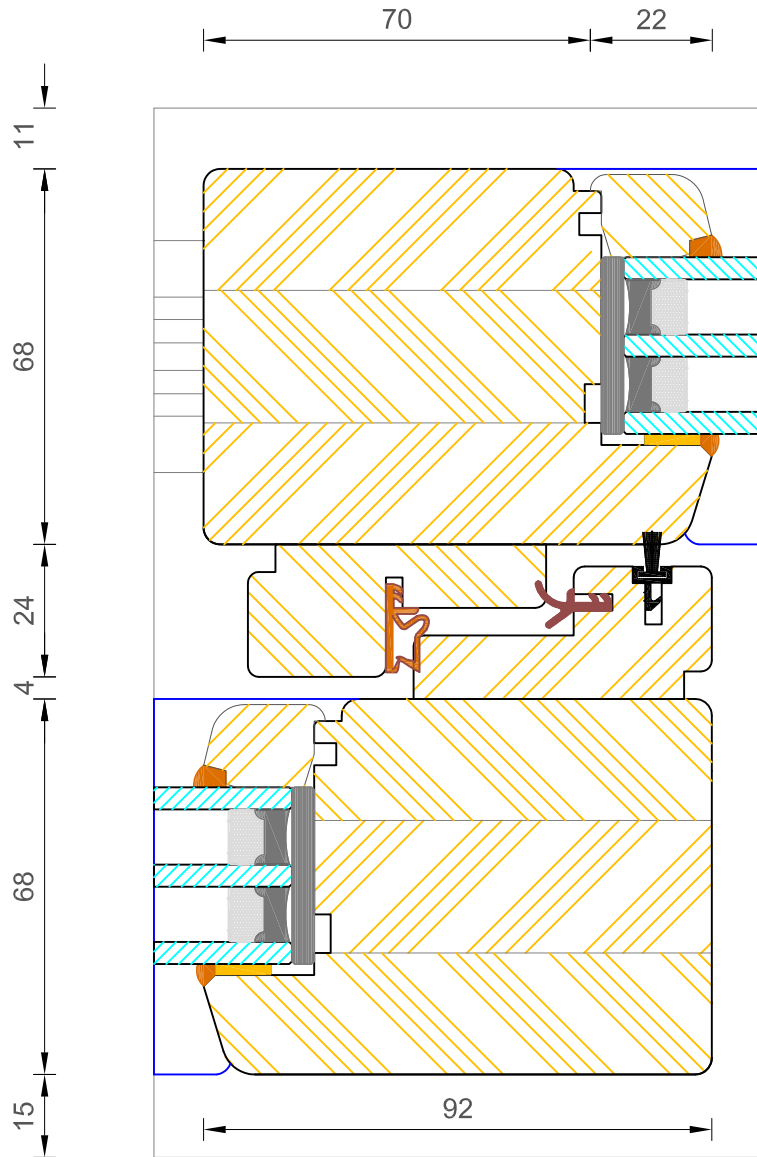

Contemporary HS Sliding Patio Door
Triple Glazed - Meeting Rail

DIMENSIONS	PLOT SIZE	SCALE	DATE	REV	DWG NO.
MM	A3	1:1	11.10.2018	B	1443
Please consider the environment before printing					

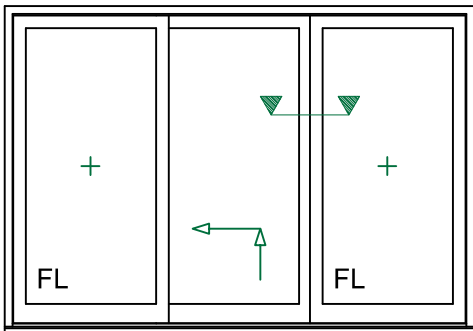
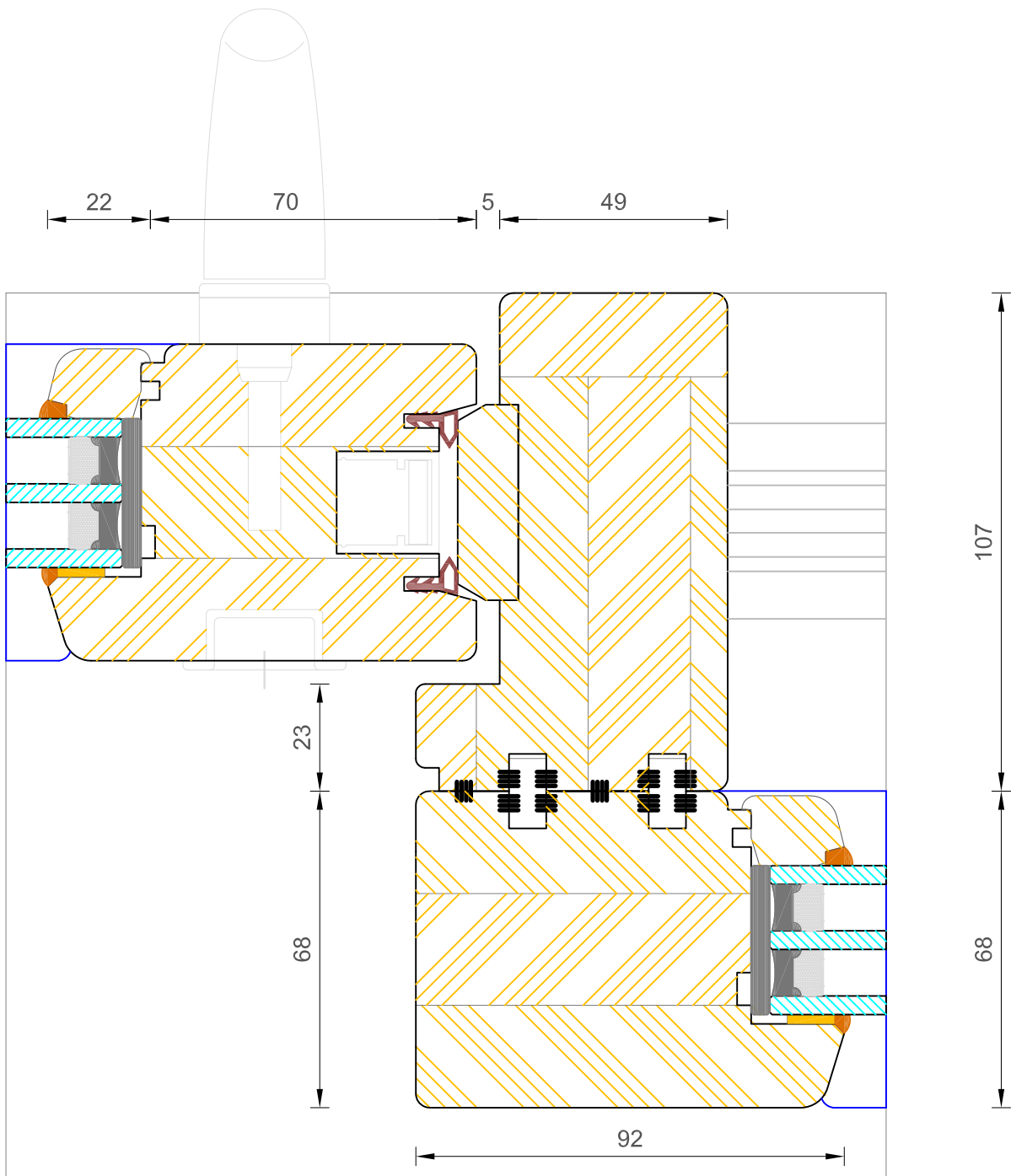

Contemporary HS Sliding Patio Door
Triple Glazed - Mullion

DIMENSIONS	PLOT SIZE	SCALE	DATE	REV	DWG NO.
MM	A3	1:1	11.10.2018	B	1444

 Please consider the environment before printing

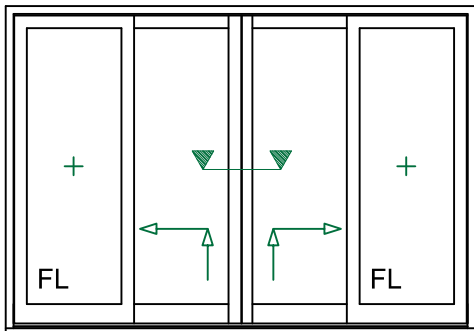
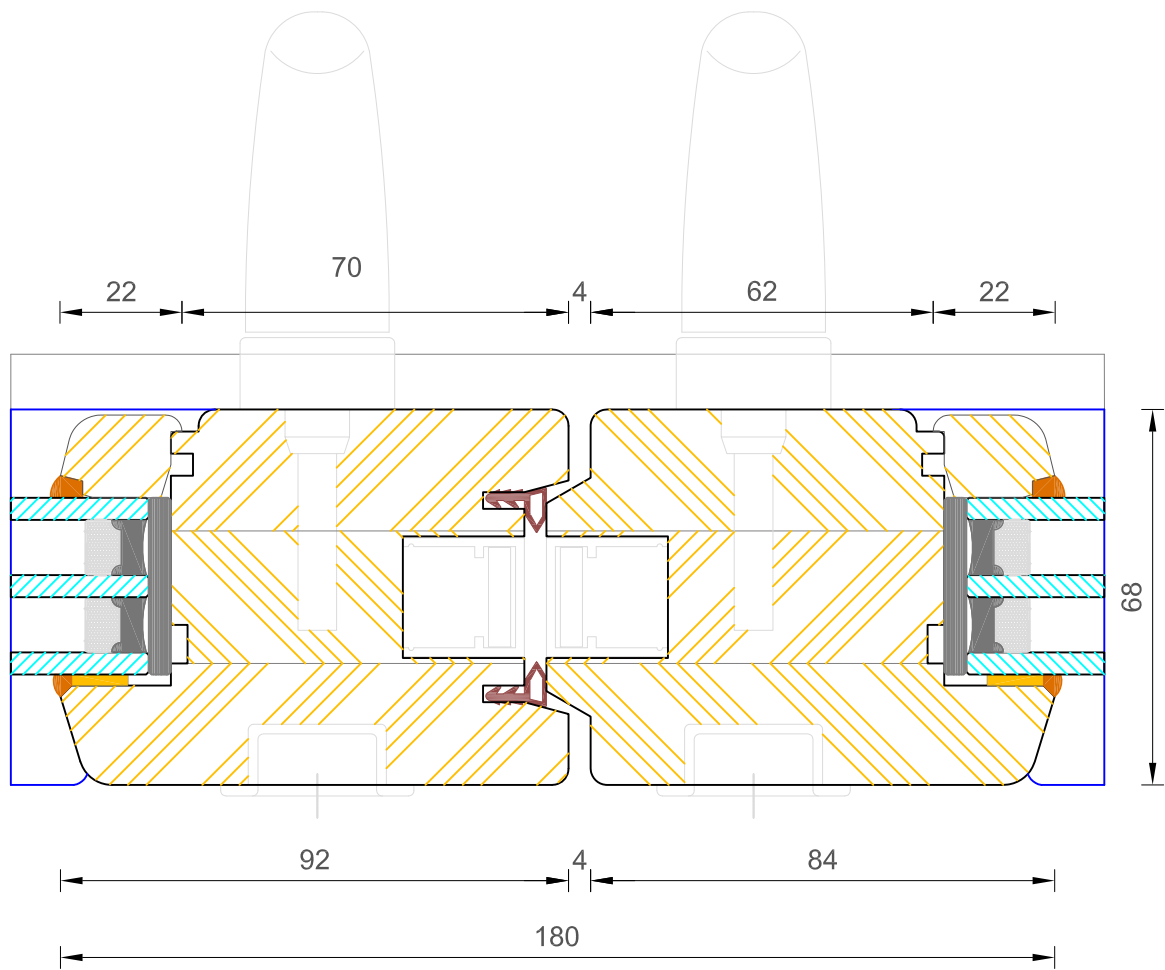

Contemporary HS Sliding Patio Door
Triple Glazed - Flying Mullion

DIMENSIONS	PLOT SIZE	SCALE	DATE	REV	DWG NO.
MM	A3	1:1	11.10.2018	B	1446

Please consider the environment before printing

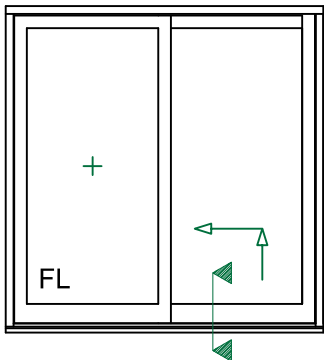
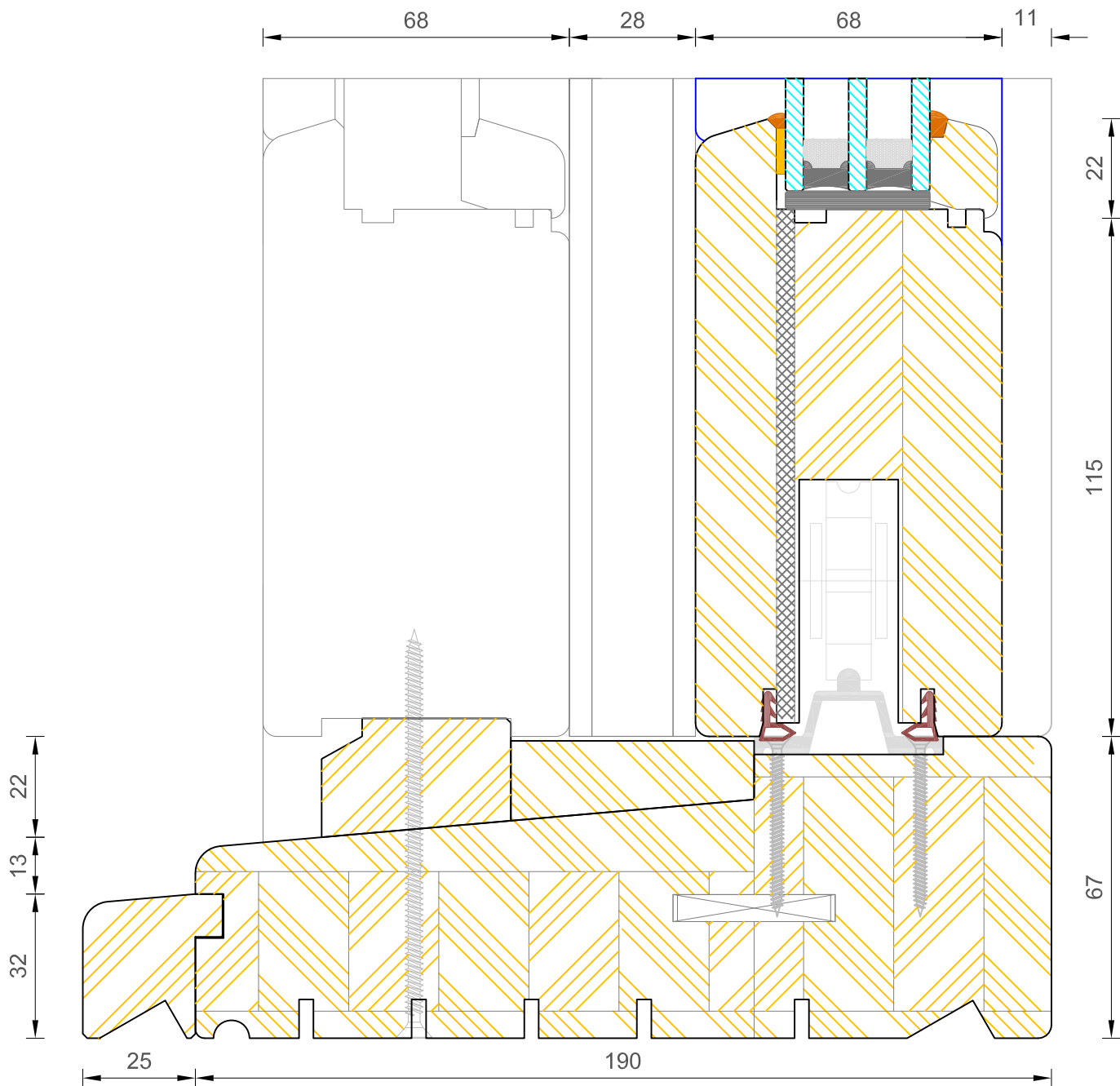

CILL EXTENSION - available options: 25mm (211mm o/a) / 47mm (233mm o/a) / 62mm (252mm o/a) / 87mm (277mm o/a) / 114mm (304mm o/a) / 125mm (315mm o/a) / 140mm (330mm o/a)

NOTE: Cill Extensions should be supported from underneath; the maximum overhang over Brick / Blockwork for cill extension should not exceed 25mm in order to avoid damage when stepped on. Warranties are invalidated when fitted with overhang in excess to that.

Contemporary HS Sliding Patio Door Triple Glazed - Thresh Opening Leaf

DIMENSIONS	PLOT SIZE	SCALE	DATE	REV	DWG NO.
MM	A3	1:1	11.10.2018	B	1440

Please consider the environment before printing

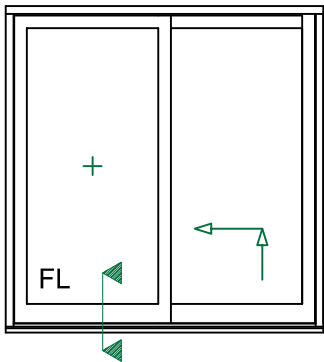
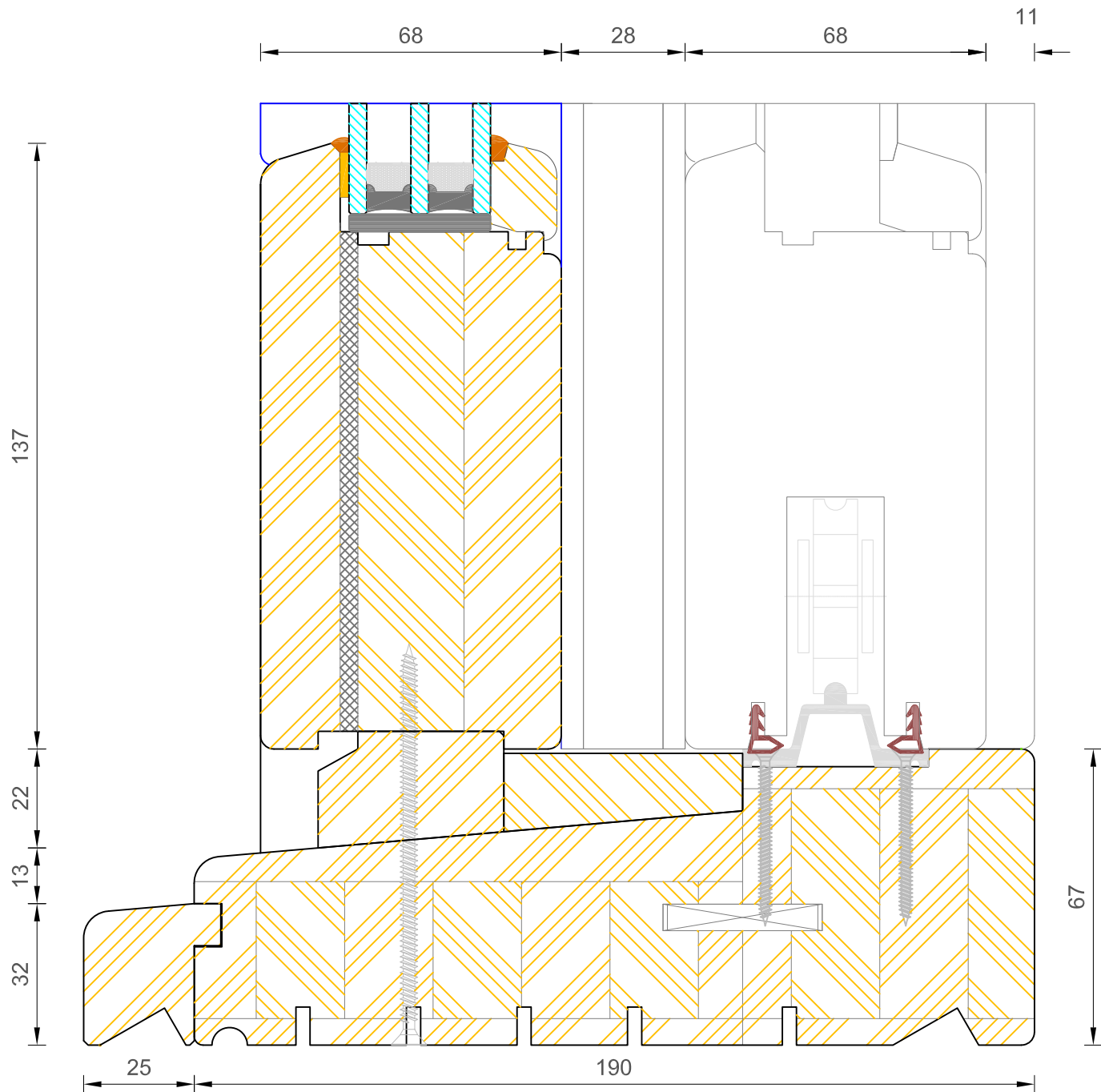

CILL EXTENSION - available options: 25mm (211mm o/a) / 47mm (233mm o/a) / 62mm (248mm o/a) / 87mm (273mm o/a) / 114mm (300mm o/a) / 125mm (311mm o/a) / 140mm (326mm o/a)

NOTE: Cill Extensions should be supported from underneath; the maximum overhang over Brick / Blockwork for cill extension should not exceed 25mm in order to avoid damage when stepped on. Warranties are invalidated when fitted with overhang in excess to that.

Contemporary HS Sliding Patio Door Triple Glazed - Thresh Fixed Leaf

DIMENSIONS	PLOT SIZE	SCALE	DATE	REV	DWG NO.
MM	A3	1:1	11.10.2018	B	1441

Please consider the environment before printing