

OPTIONAL
no sub cill

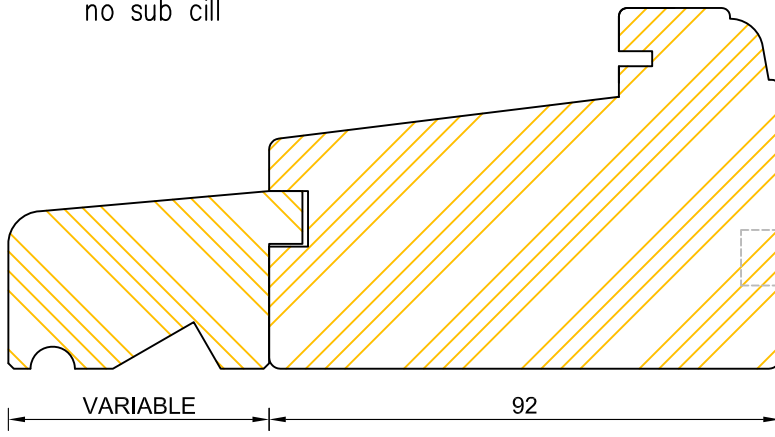

OPTIONAL
CILL BOARD
GROOVE

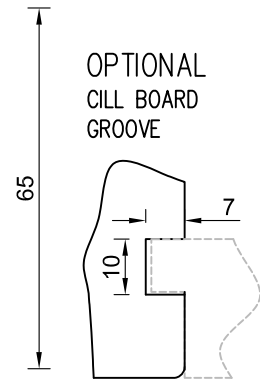

CILL EXTENSION – available options:

- | | | |
|----------------------|-----------------------|-----------------------|
| 25mm (117mm overall) | 87mm (179mm overall) | 125mm (217mm overall) |
| 47mm (139mm overall) | 100mm (192mm overall) | 140mm (232mm overall) |
| 62mm (154mm overall) | 114mm (205mm overall) | |

STANDARD
one piece subcill

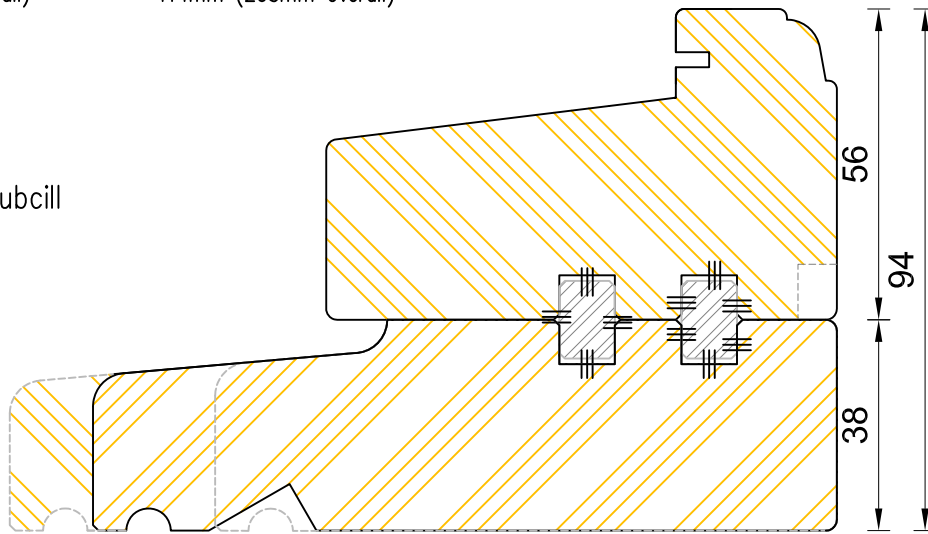

OPTIONAL
CILL BOARD
GROOVE

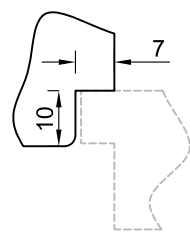

SUBCILL SIZES – 112mm / 134mm / 149mm overall

STANDARD
subcill with cill extension

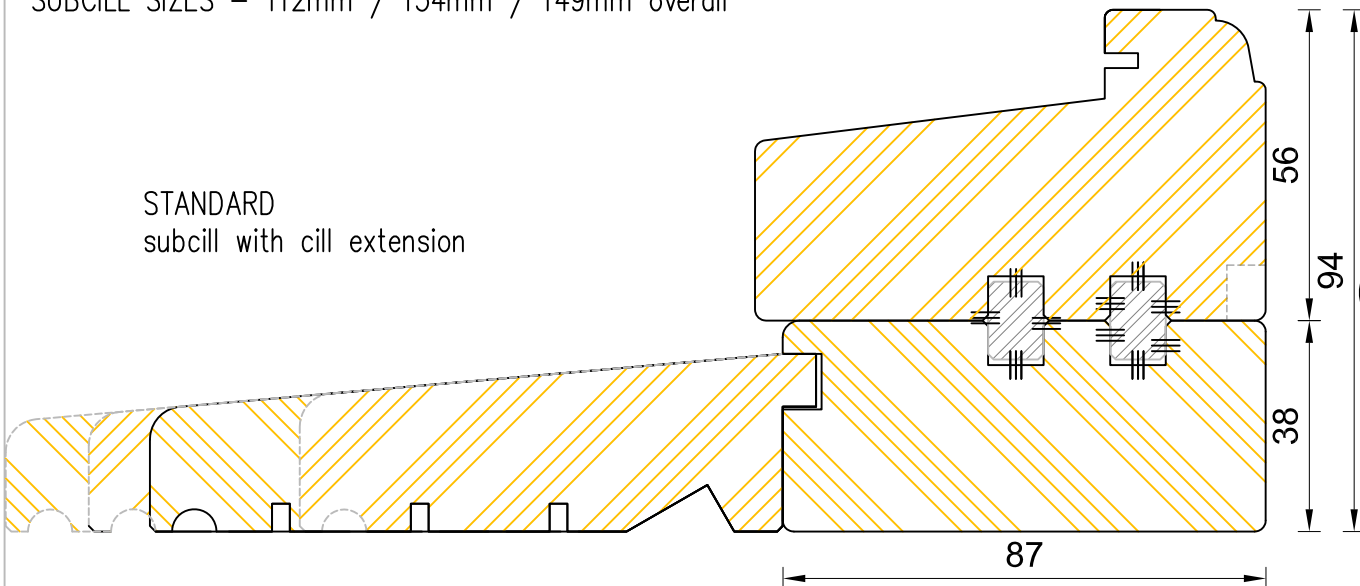

OPTIONAL
CILL BOARD
GROOVE

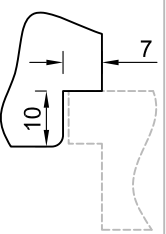

CILL EXTENSION – available options:

- | |
|-----------------------|
| 87mm (174mm overall) |
| 114mm (201mm overall) |
| 125mm (212mm overall) |
| 140mm (227mm overall) |



Traditional Flush Casement Window Cill Options

DIMENSIONS	PLOT SIZE	SCALE	DATE	REV	DWG NO.
MM	A3	1:1	15.04.2011	A	1801.1
Please consider the environment before printing					

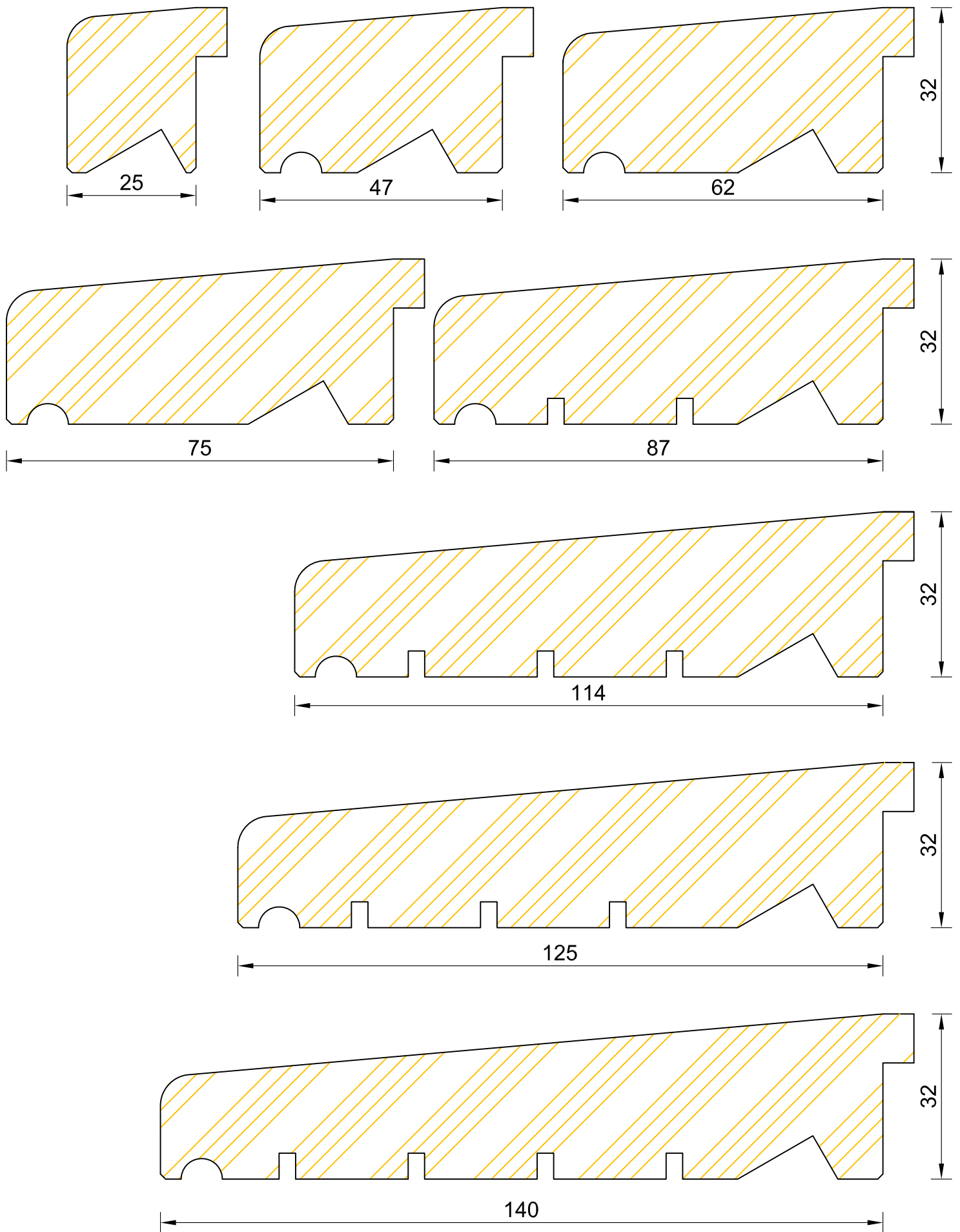

Traditional Flush Casement Window Cill Extension Options

DIMENSIONS	PLOT SIZE	SCALE	DATE	REV	DWG NO.
MM	A4	1:1	25.09.2019	B	1801.2

Please consider the environment before printing

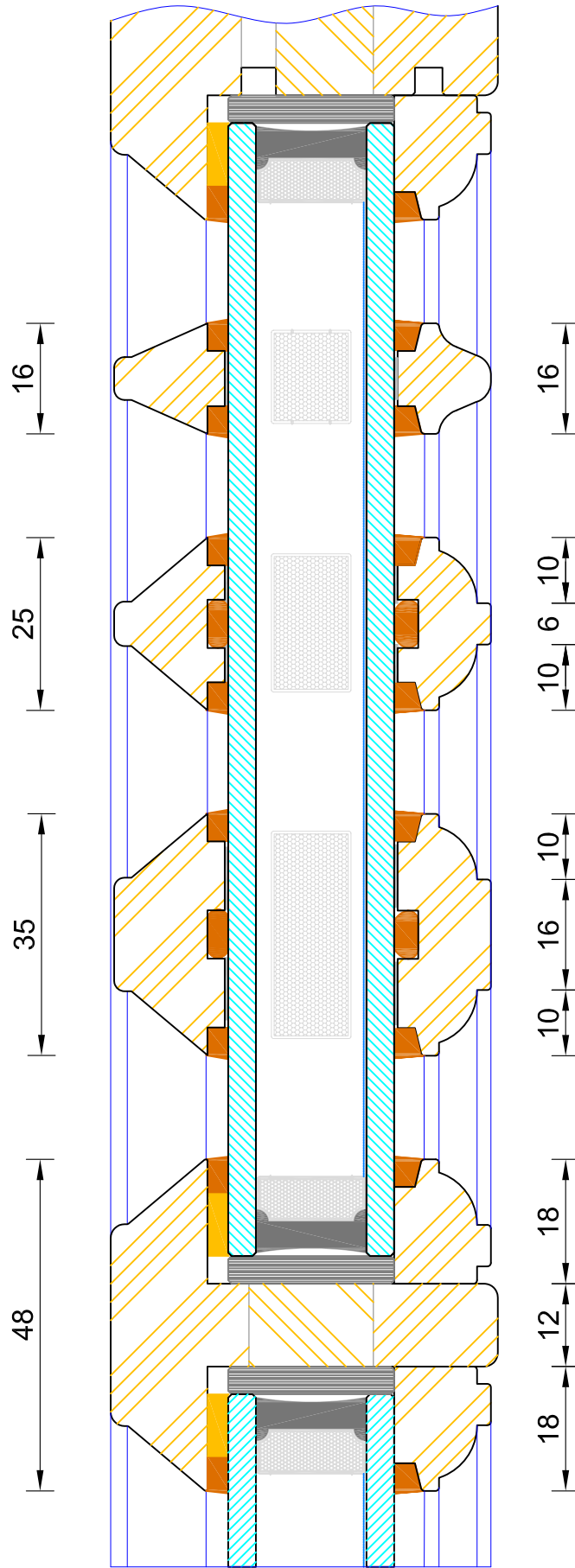

Traditional Flush Casement Window Bar Options

DIMENSIONS	PLOT SIZE	SCALE	DATE	REV	DWG NO.
MM	A4	1:1	01.01.2019	B	1802
Please consider the environment before printing					

HEAD DRIP - Included only if vents are required

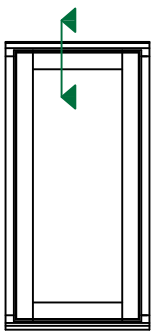
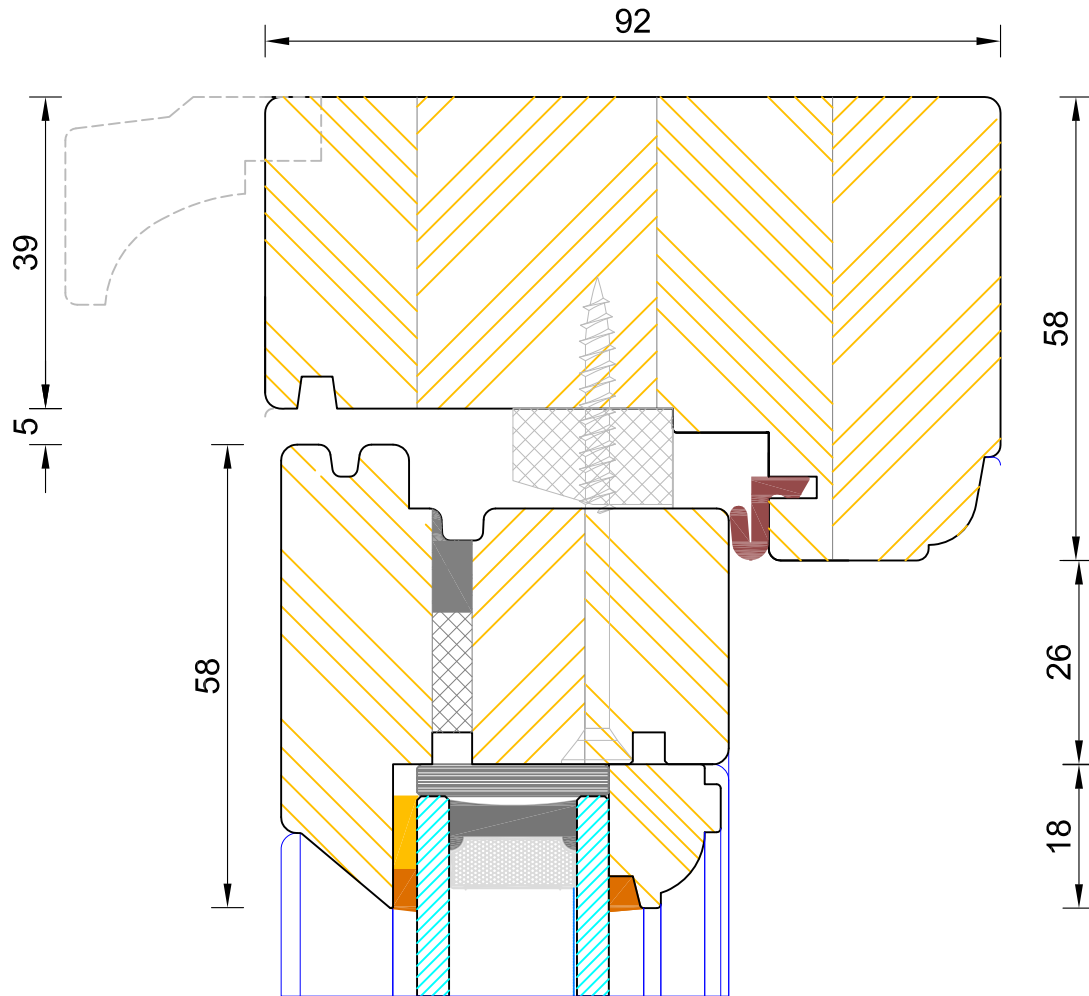

**Traditional Flush Casement Window
Frame & Sash Head (Fixed Sash)**

DIMENSIONS	PLOT SIZE	SCALE	DATE	REV	DWG NO.
MM	A4	1:1	20.02.2018	B	1803
Please consider the environment before printing					

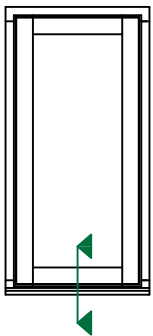
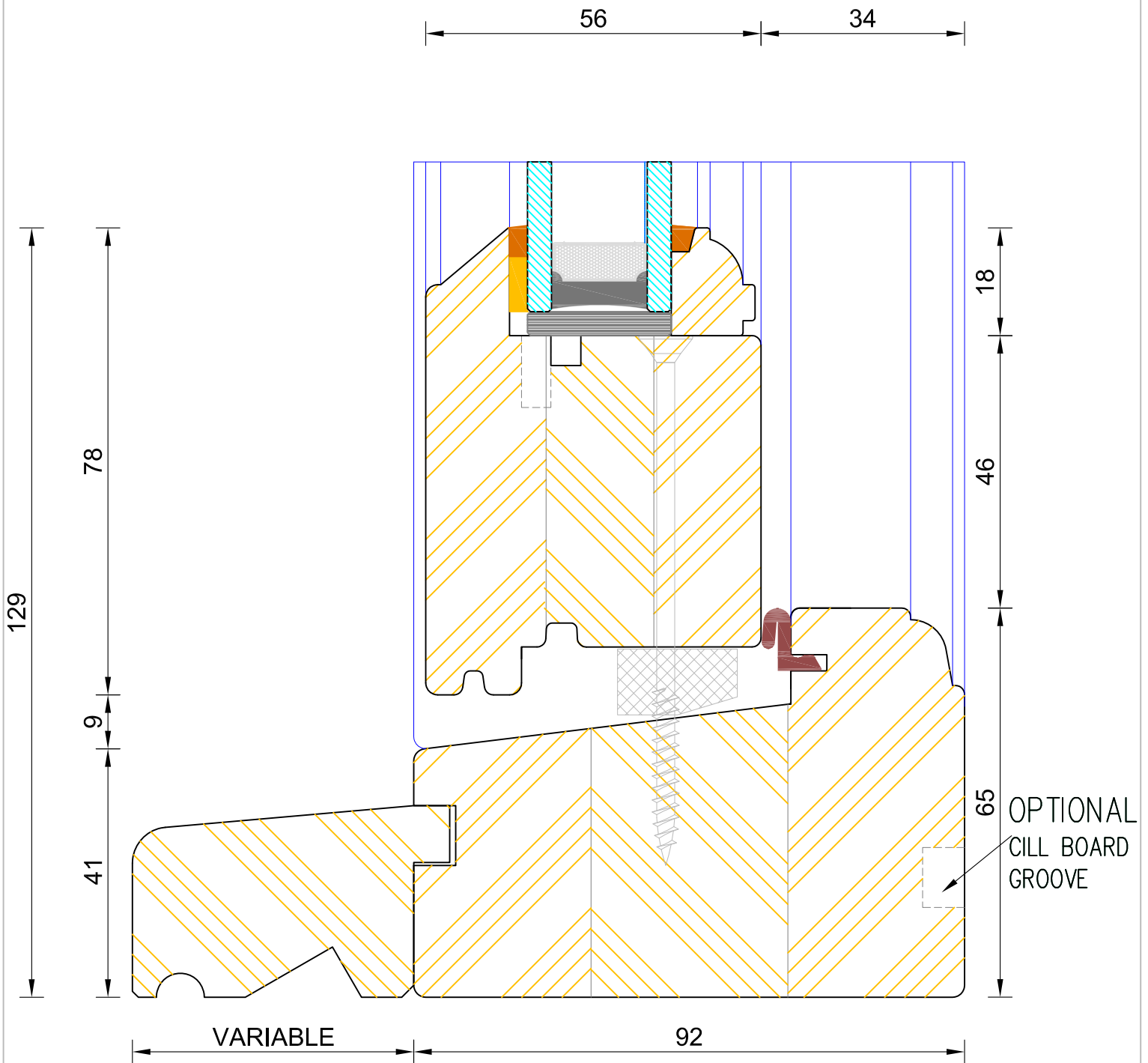

CILL EXTENSION - available options:
 25mm (112mm o/a) / 47mm (134mm o/a) / 62mm (149mm o/a) /
 87mm (174mm o/a) / 100mm (192mm o/a) / 114mm (201mm o/a) /
 125mm (212mm o/a) / 140mm (227mm o/a)



**Traditional Flush Casement Window
 Frame & Sash Cill (Fixed Sash)**

DIMENSIONS	PLOT SIZE	SCALE	DATE	REV	DWG NO.
MM	A4	1:1	15.04.2011	A	1804.1
Please consider the environment before printing					

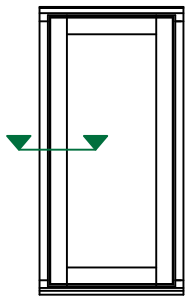
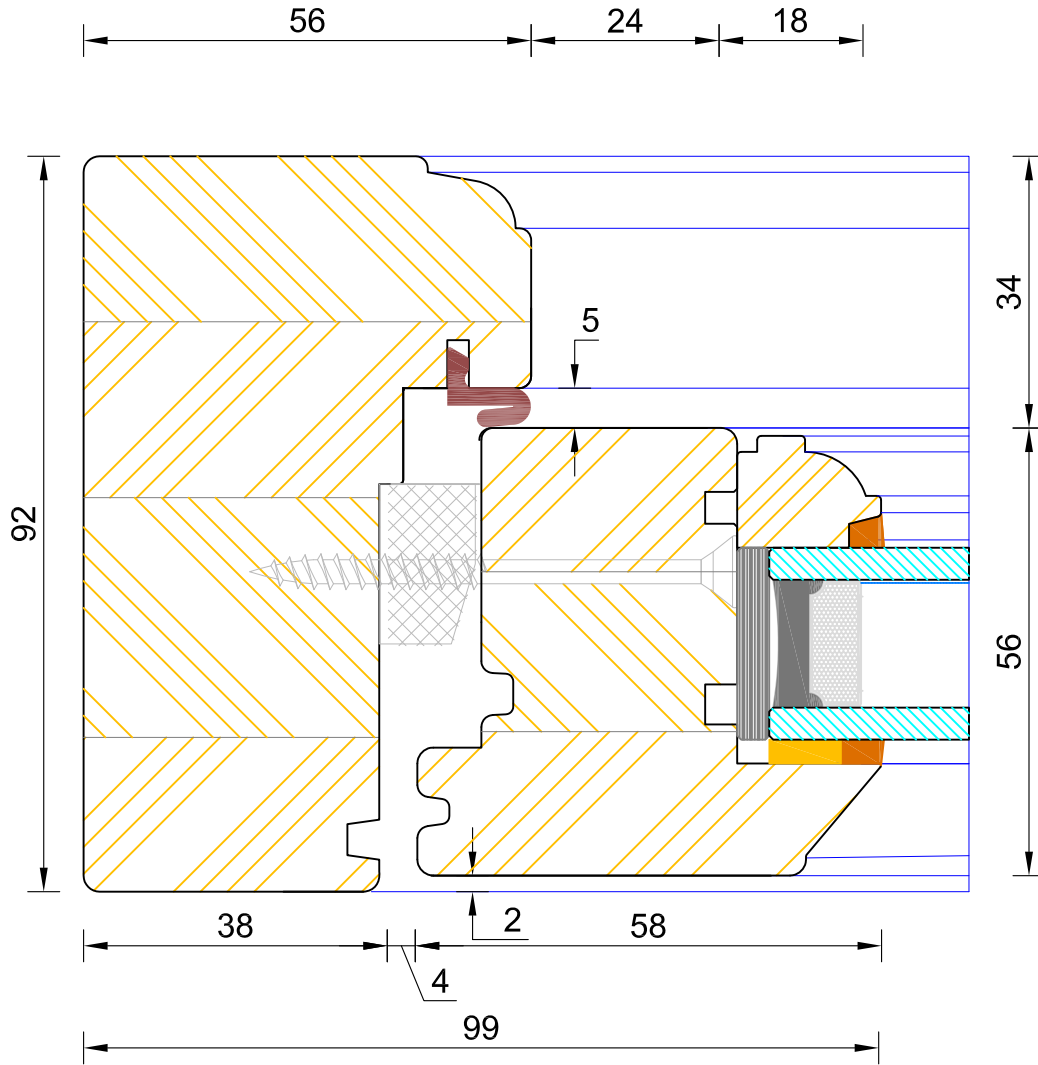

**Traditional Flush Casement Window
Frame & Sash Jamb (Fixed Sash)**

DIMENSIONS	PLOT SIZE	SCALE	DATE	REV	DWG NO.
MM	A4	1:1	15.04.2011	A	1805
Please consider the environment before printing					

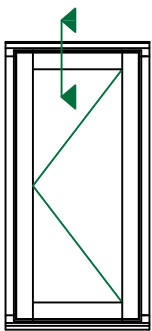
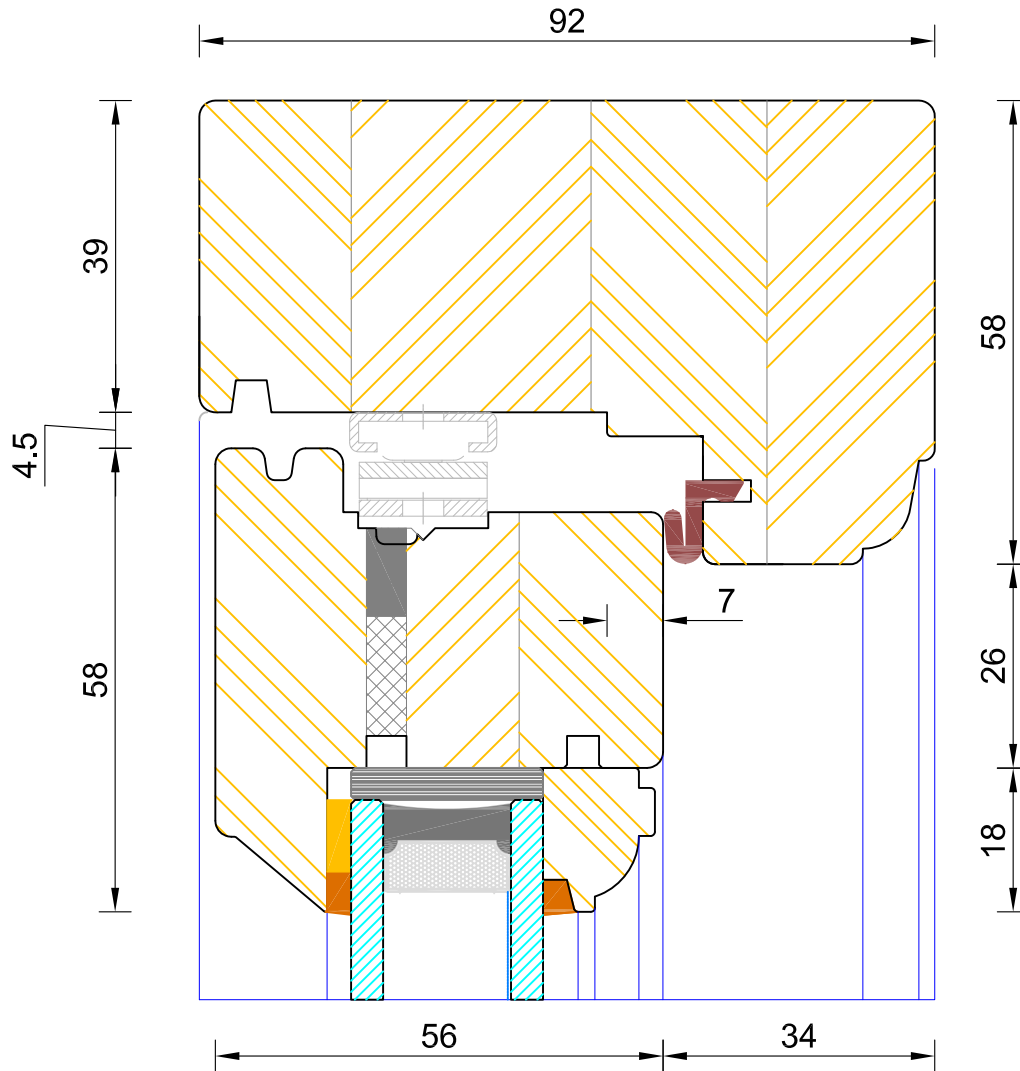

**Traditional Flush Casement Window
Frame & Sash Head (Without Vent)**

DIMENSIONS	PLOT SIZE	SCALE	DATE	REV	DWG NO.
MM	A4	1:1	20.02.2018	A	1806
Please consider the environment before printing					

HEAD DRIP - Included only if vents are required

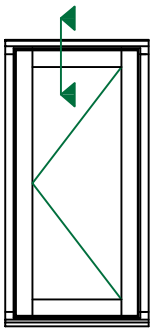
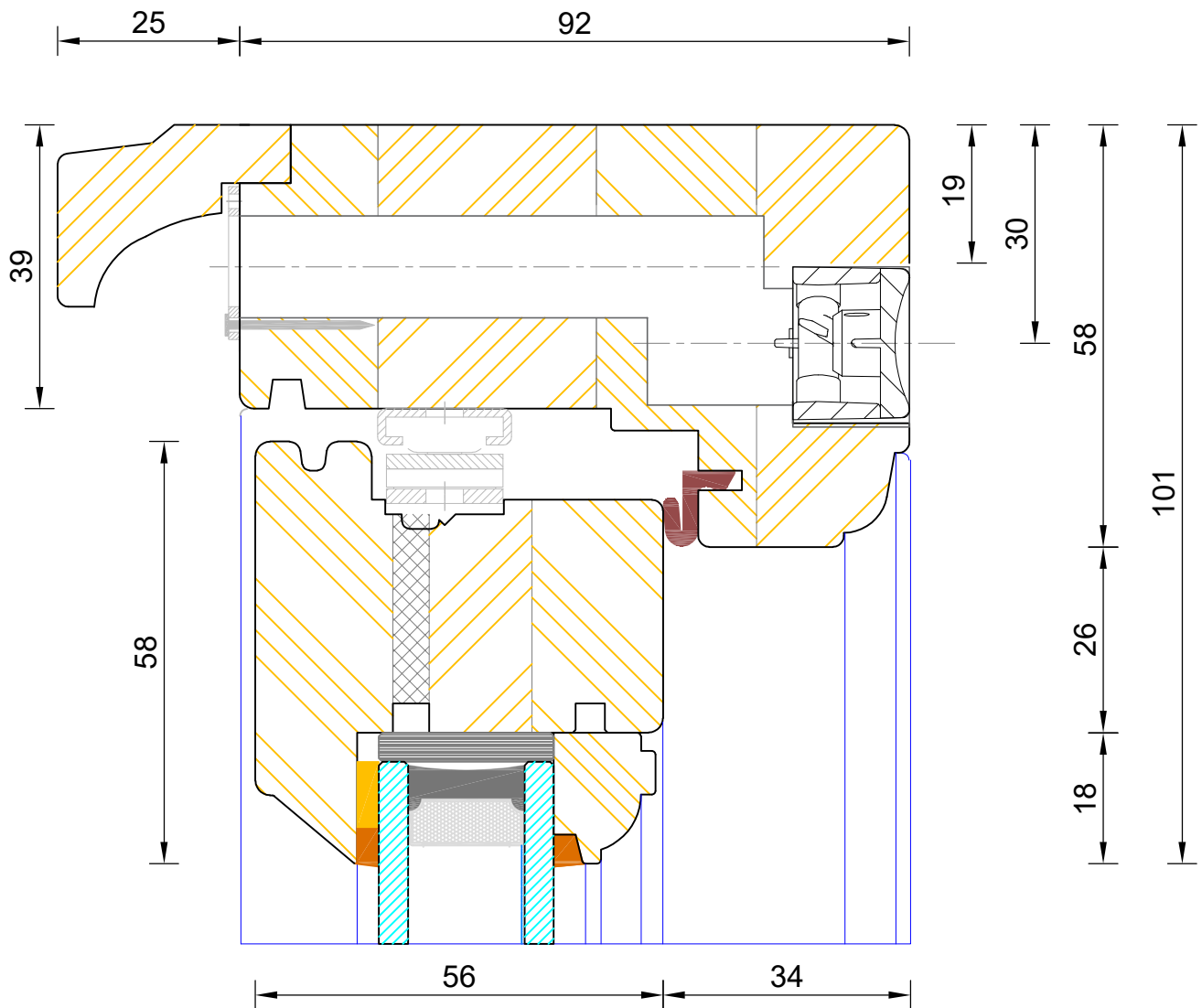

Traditional Flush Casement Window
 Frame & Sash Head (Standard 58mm Head With Vent)

DIMENSIONS	PLOT SIZE	SCALE	DATE	REV	DWG NO.
MM	A4	1:1	05.07.2022	A	1806.1
Please consider the environment before printing					

HEAD DRIP - Included only if vents are required

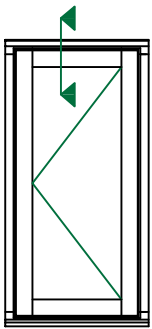
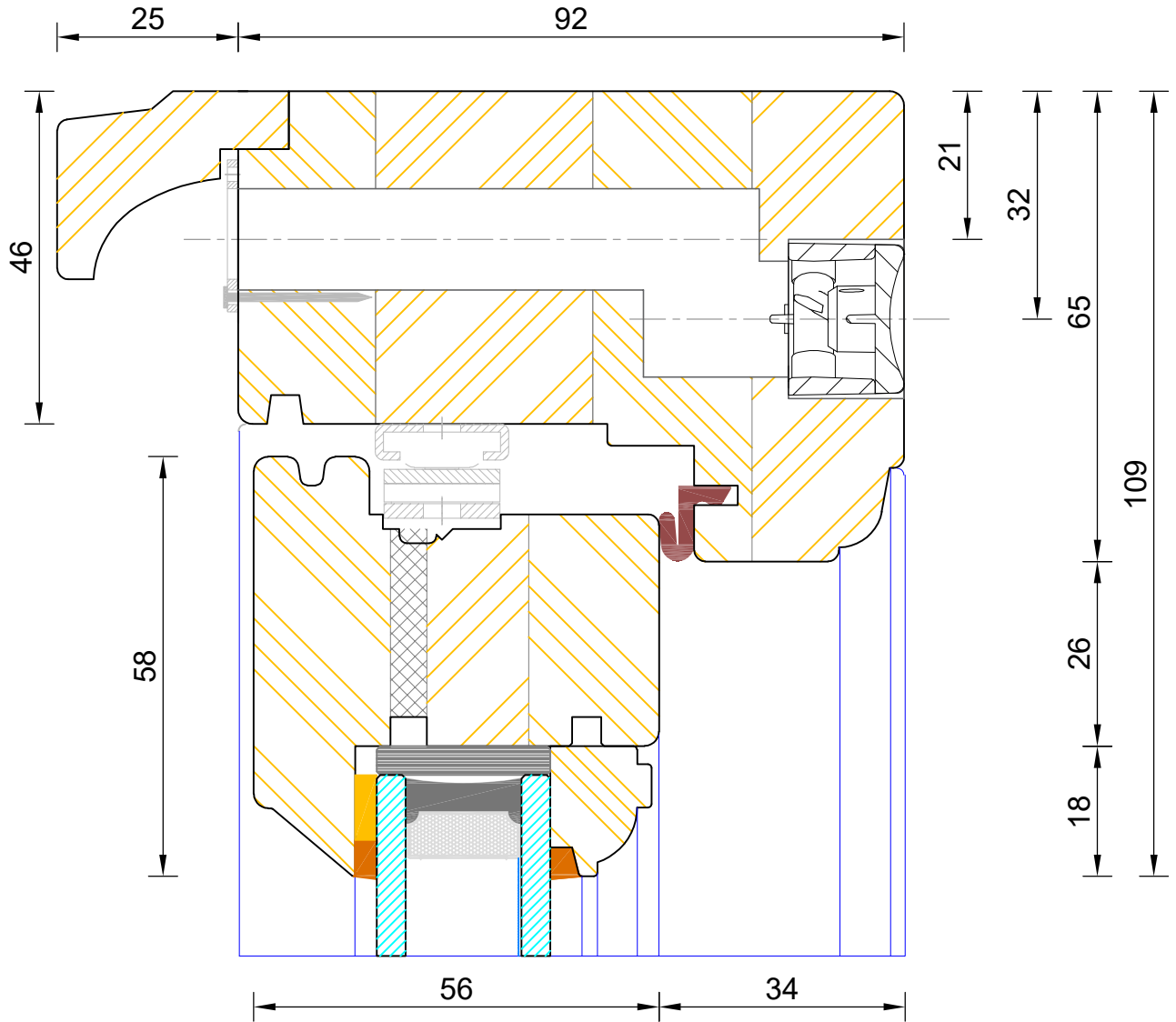

Traditional Flush Casement Window
 Frame & Sash Head (Optional 65mm Head With Vent)

DIMENSIONS	PLOT SIZE	SCALE	DATE	REV	DWG NO.
MM	A4	1:1	05.07.2022	C	1806.2

Please consider the environment before printing

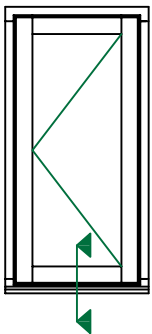
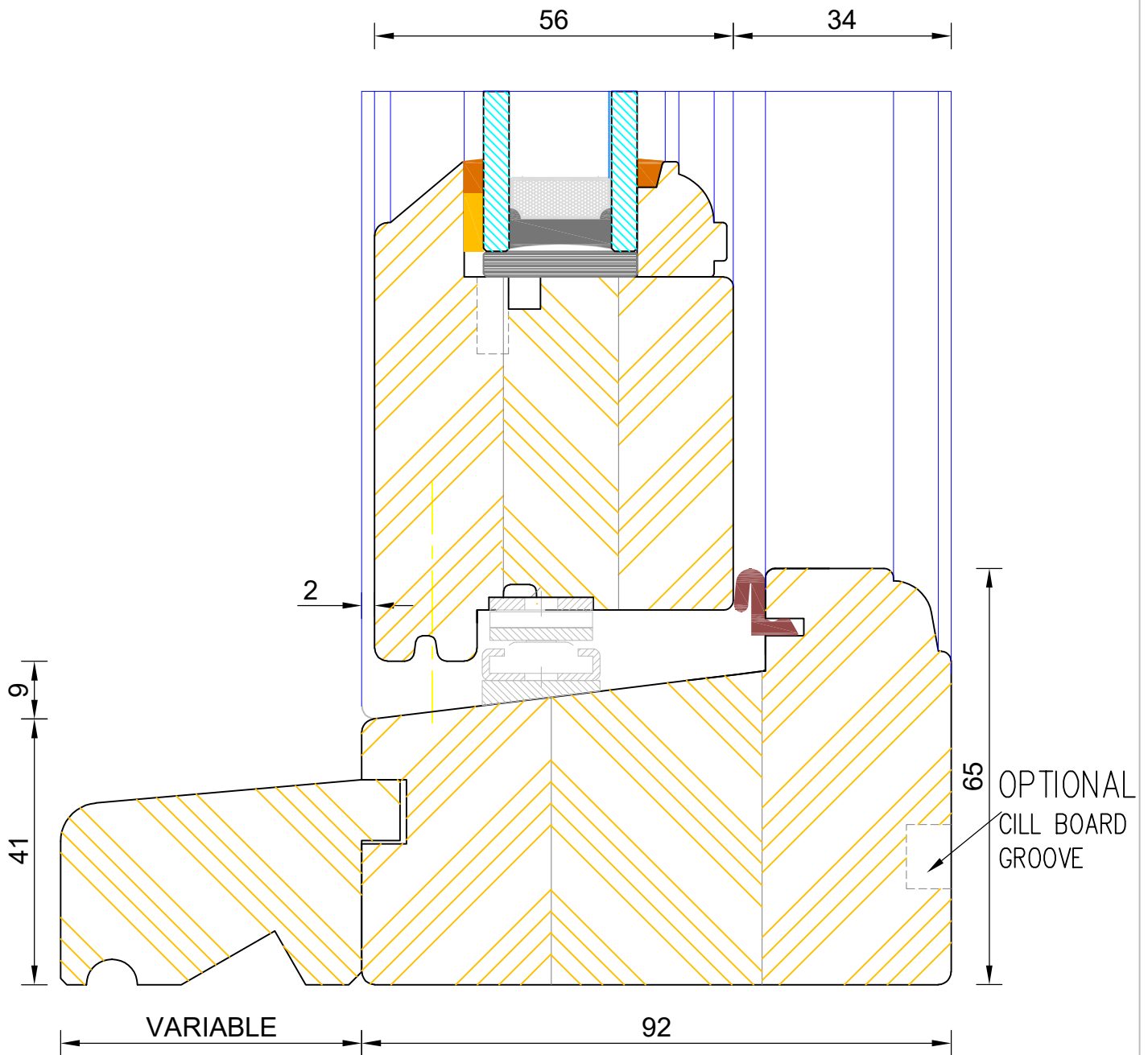

CILL EXTENSION - available options:

- 25mm (112mm o/a) / 47mm (134mm o/a) / 62mm (149mm o/a) /
- 87mm (174mm o/a) / 100mm (192mm o/a) / 114mm (201mm o/a) /
- 125mm (212mm o/a) / 140mm (227mm o/a)



Traditional Flush Casement Window Frame & Sash Cill (With Easy Clean Hinge)

DIMENSIONS	PLOT SIZE	SCALE	DATE	REV	DWG NO.
MM	A4	1:1	15.04.2011	A	1807.2
Please consider the environment before printing					

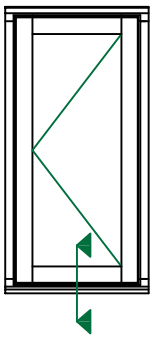
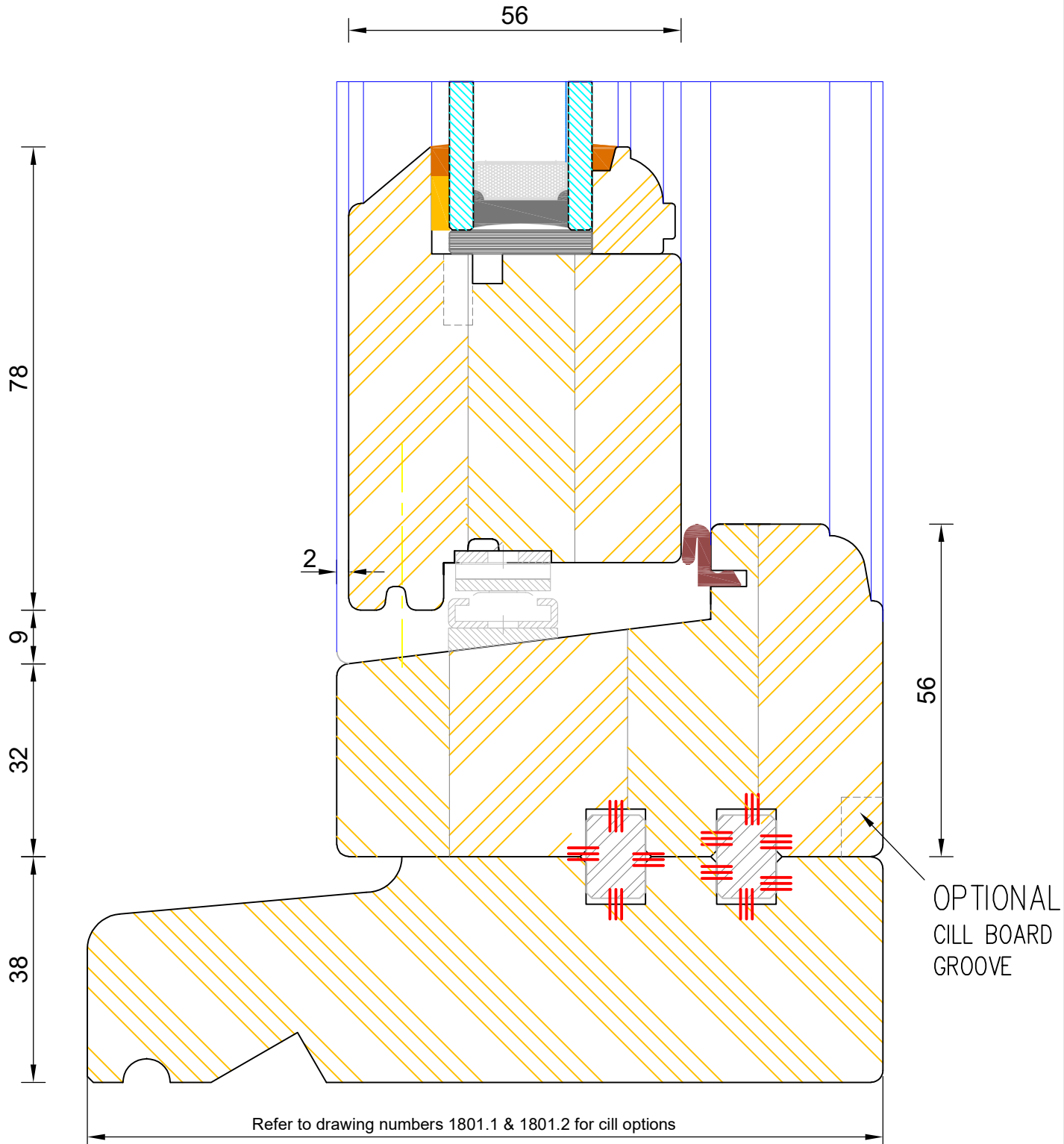

Traditional Flush Casement Window
Frame & Sash Cill (With Subcill & Easy Clean Hinge)

DIMENSIONS	PLOT SIZE	SCALE	DATE	REV	DWG NO.
MM	A4	1:1	15.04.2011	A	1807.3
Please consider the environment before printing					

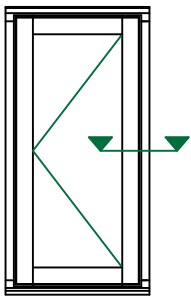
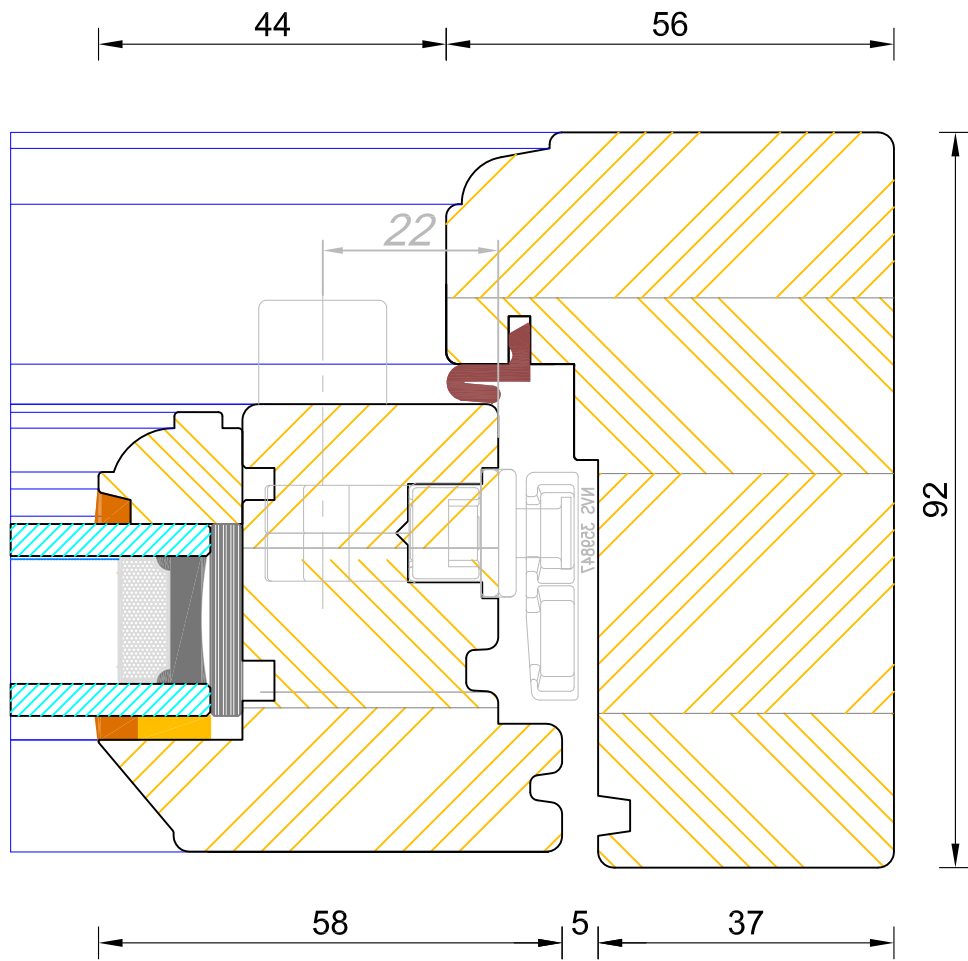

**Traditional Flush Casement Window
Frame & Sash Jamb (handle Side)**

DIMENSIONS	PLOT SIZE	SCALE	DATE	REV	DWG NO.
MM	A4	1:1	15.04.2011	A	1808

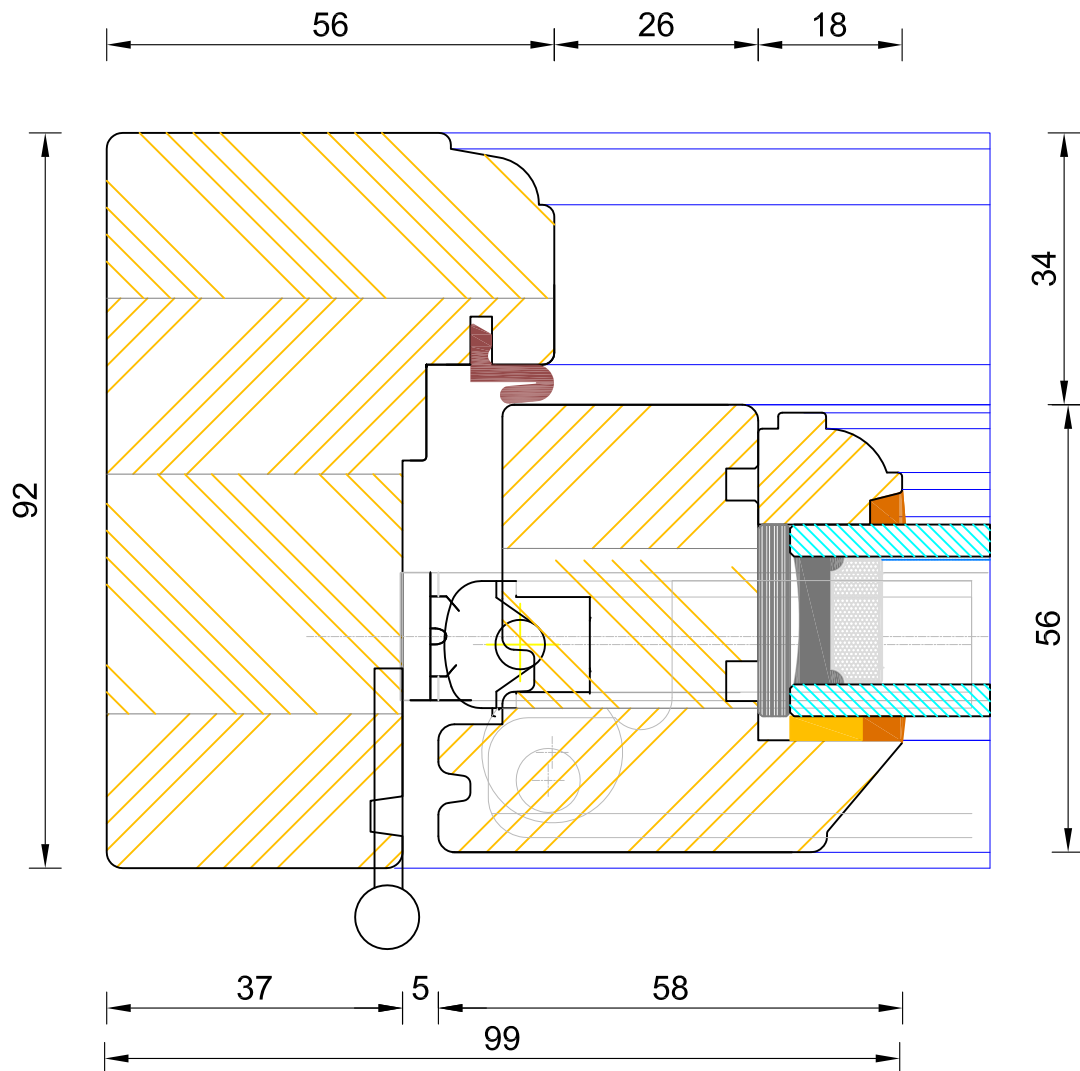

Note:
 Jamb section shown with GU Hinge
 Dummy Butt Hinge - Optional

Available Hinge Options
 GU (as shown) Dummy Butt Hinge Optional
 Easy Clean
 Egress Easy Clean
 Casp
 Defender Plus

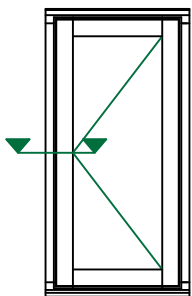

Traditional Flush Casement Window Frame & Sash Jamb (Hinge Side)

DIMENSIONS	PLOT SIZE	SCALE	DATE	REV	DWG NO.
MM	A4	1:1	15.04.2011	A	1809
Please consider the environment before printing					



Bereco

Traditional Flush Casement Window Flying Mullion (Lead / Slave Sash)

DIMENSIONS	PLOT SIZE	SCALE	DATE	REV	DWG. NO.
MM	A1	1:1	15.04.2011	A	1813.1

Please consider the environment before printing

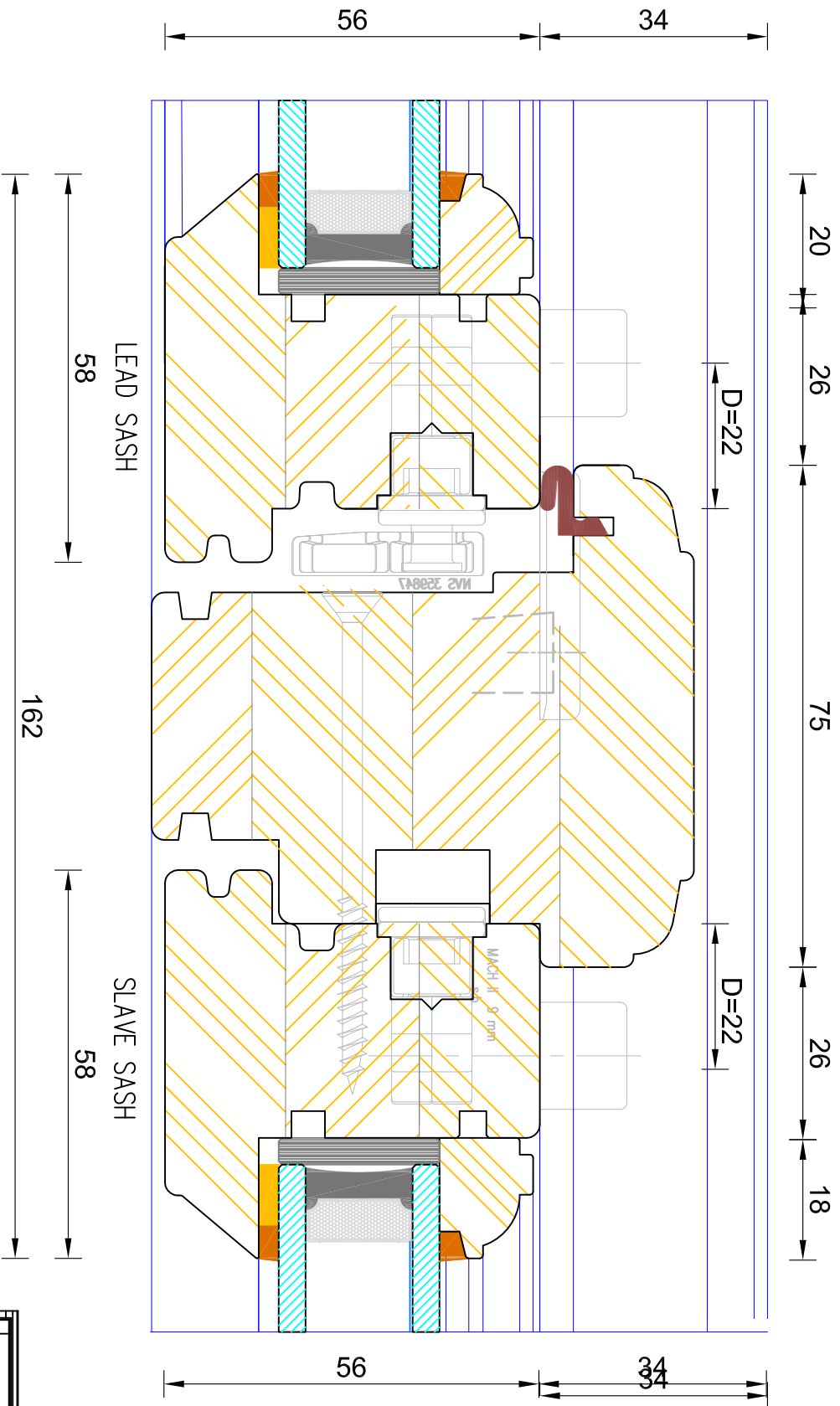
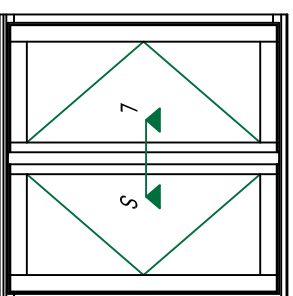



Bereco

Traditional Flush Casement Window Solid Mullion (Fixed Sash / Fixed Sash)

DIMENSIONS		PLOT SIZE	SCALE	DATE	REV	DWG. NO.
MM	A1	A1	1:1	15.04.2011	A	1812

Please consider the environment before printing

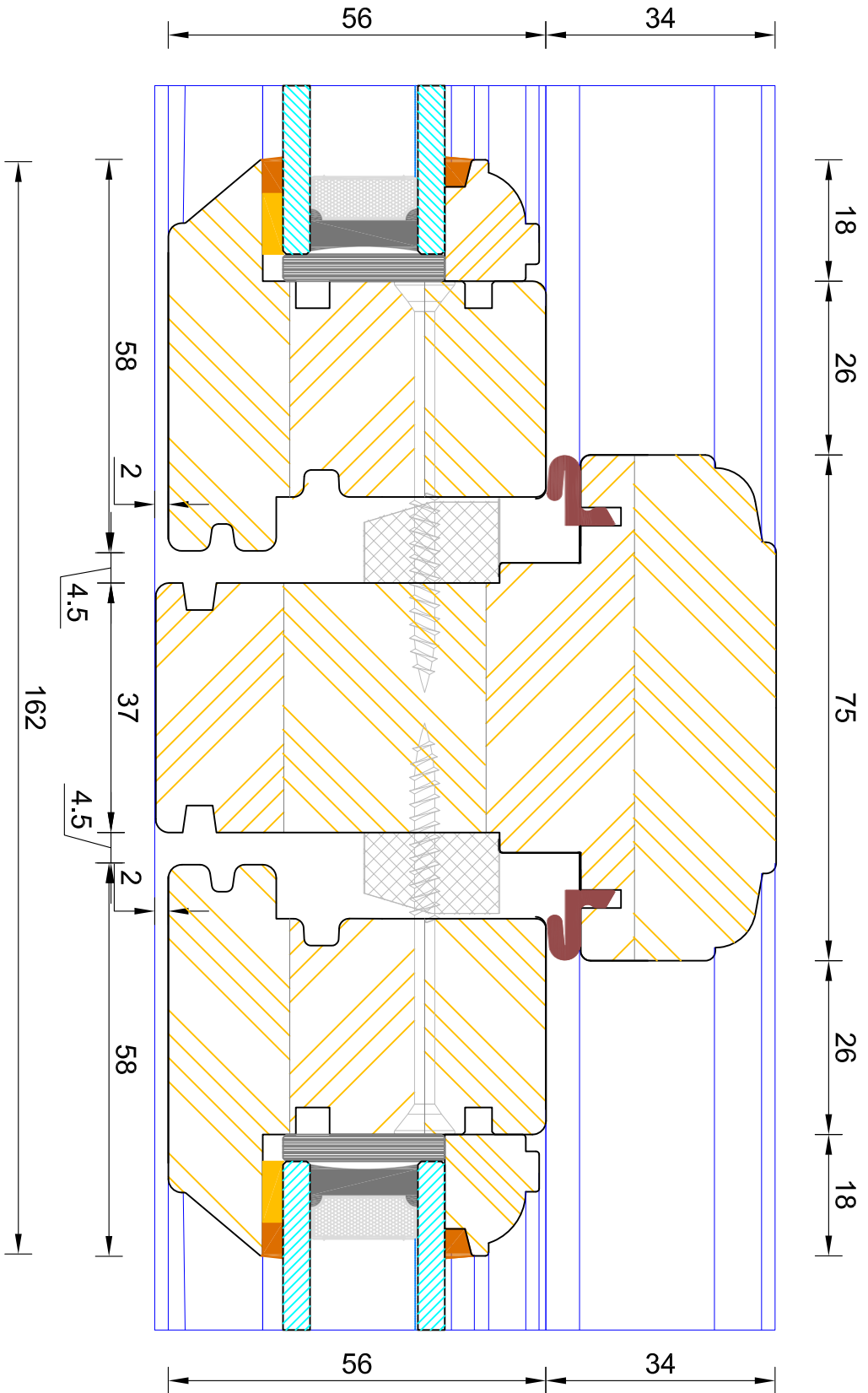
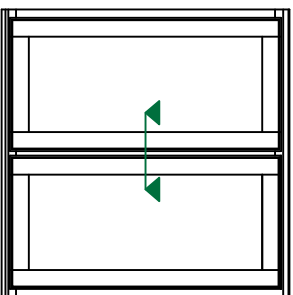



Bereco

Traditional Flush Casement Window Solid Mullion (Sash / Sash)

DIMENSIONS	PLOT SIZE	SCALE	DATE	REV	DWG. NO.
MM	A1	1:1	15.04.2011	A	18111

Please consider the environment before printing

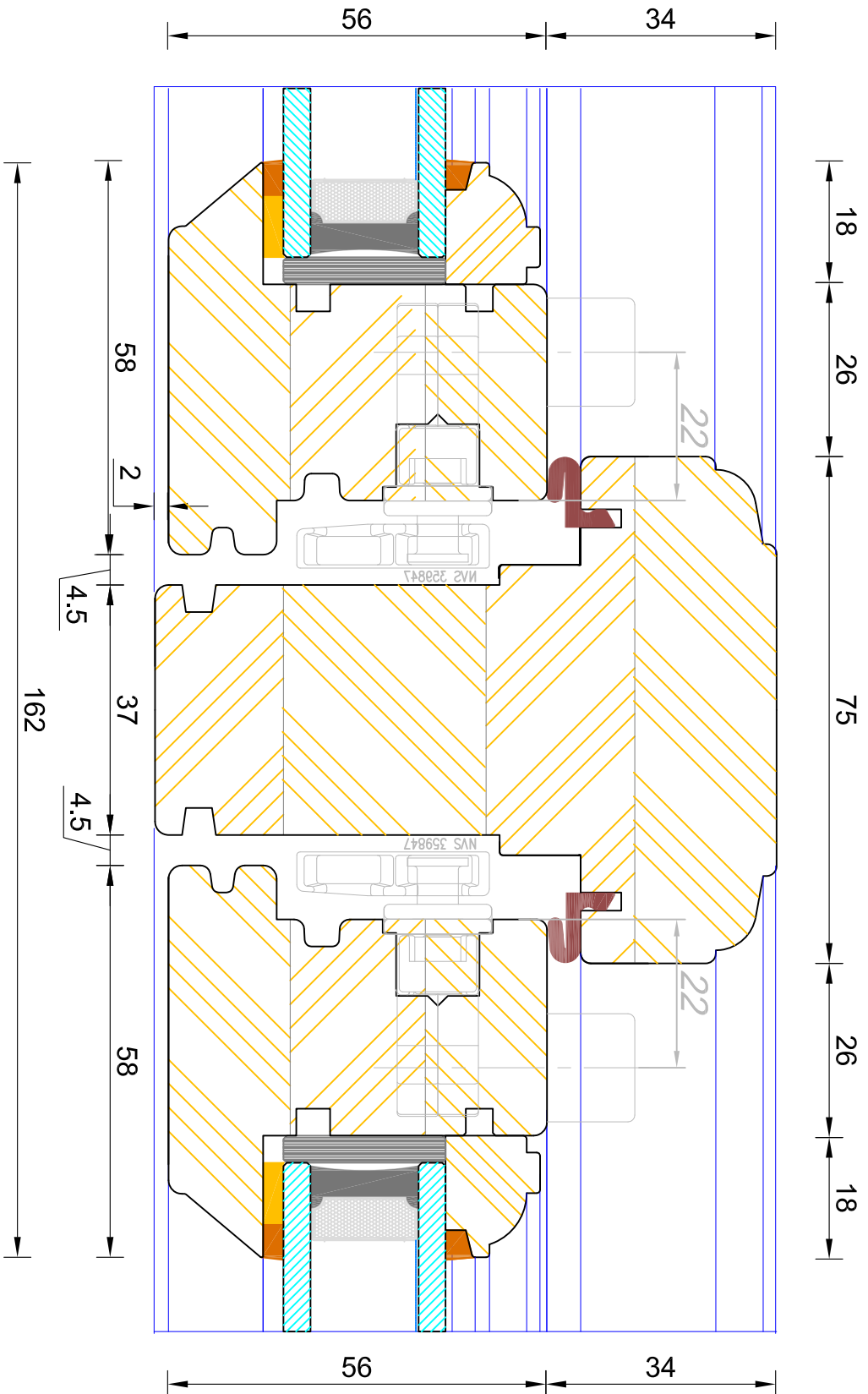
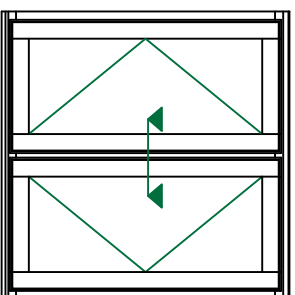



Bereco

Traditional Flush Casement Window
Solid Mullion (Fixed Sash / Sash)

DIMENSIONS	PLOT SIZE	SCALE	DATE	REV	DWG. NO.
MM	A1	1:1	15.04.2011	A	1810

Please consider the environment before printing

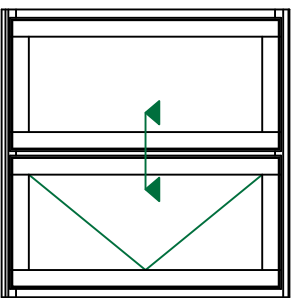
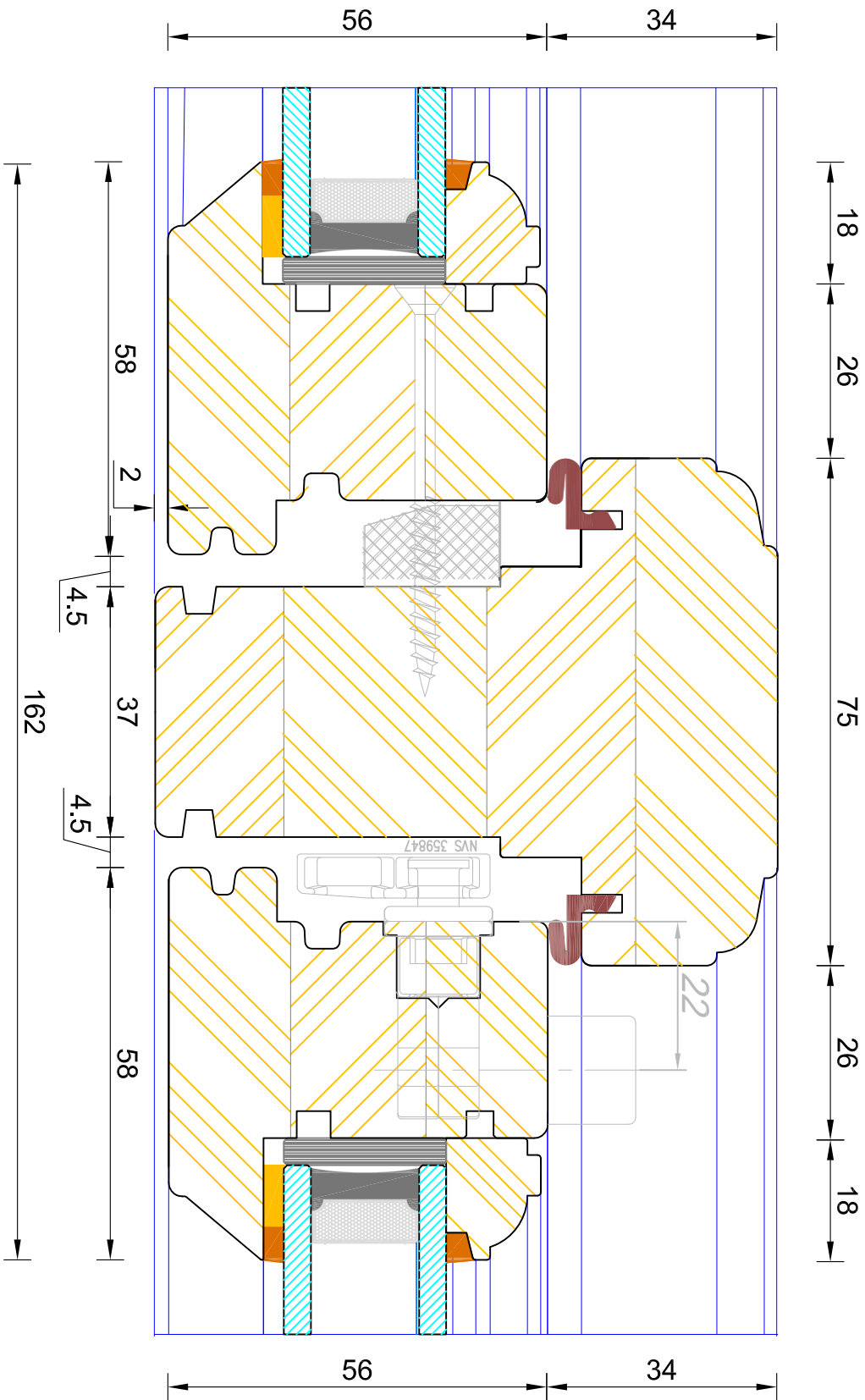

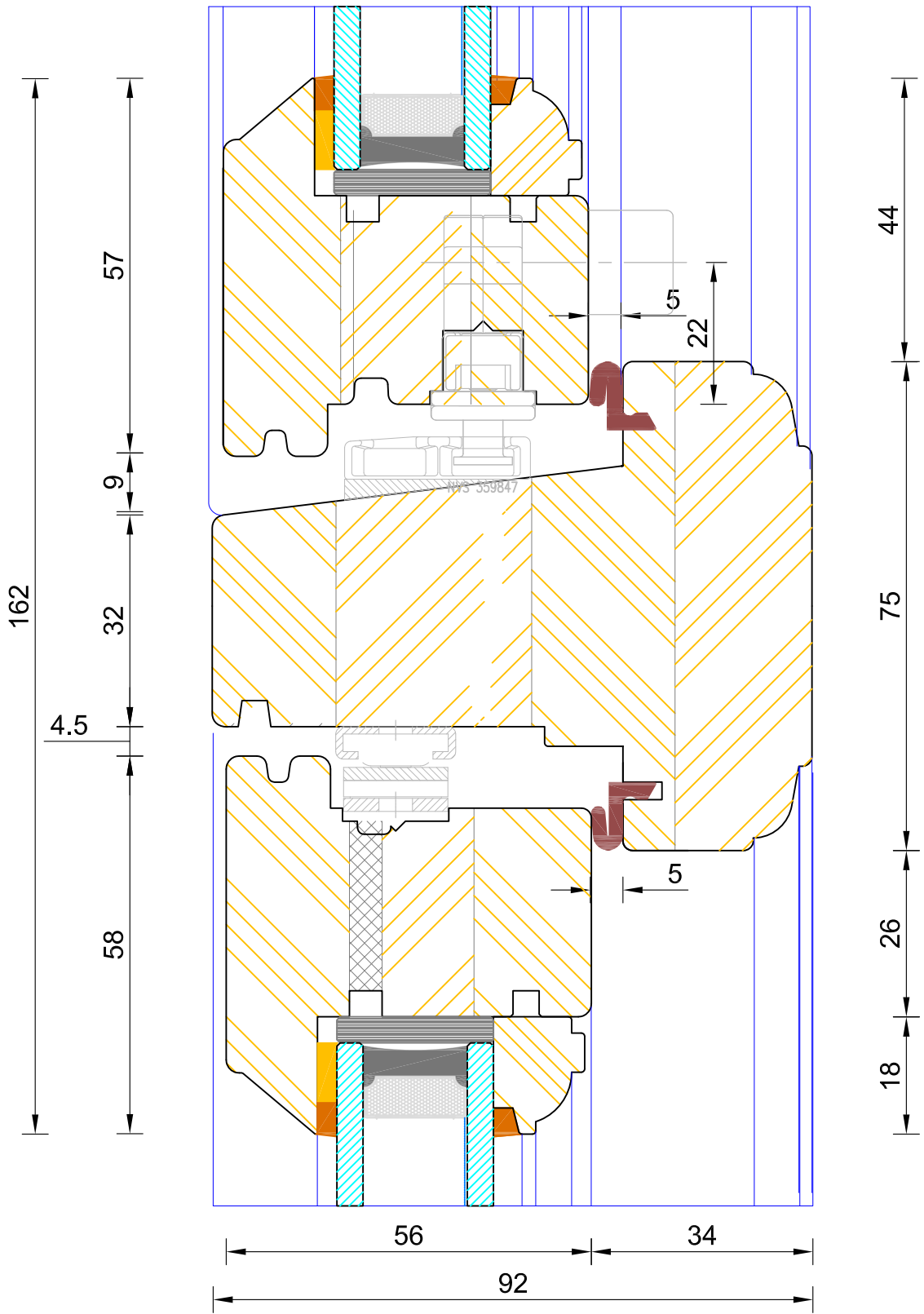
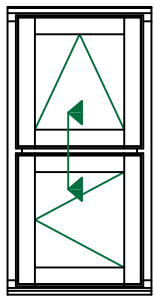

**Traditional Flush Casement Window
Solid Transom (Sash / Sash)**

DIMENSIONS	PLOT SIZE	SCALE	DATE	REV	DWG NO.
MM	A4	1:1	15.04.2011	A	1817
Please consider the environment before printing					

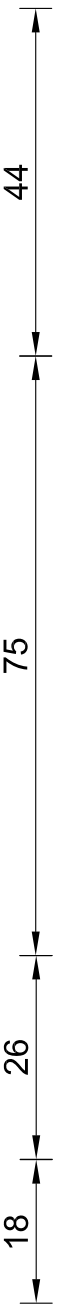
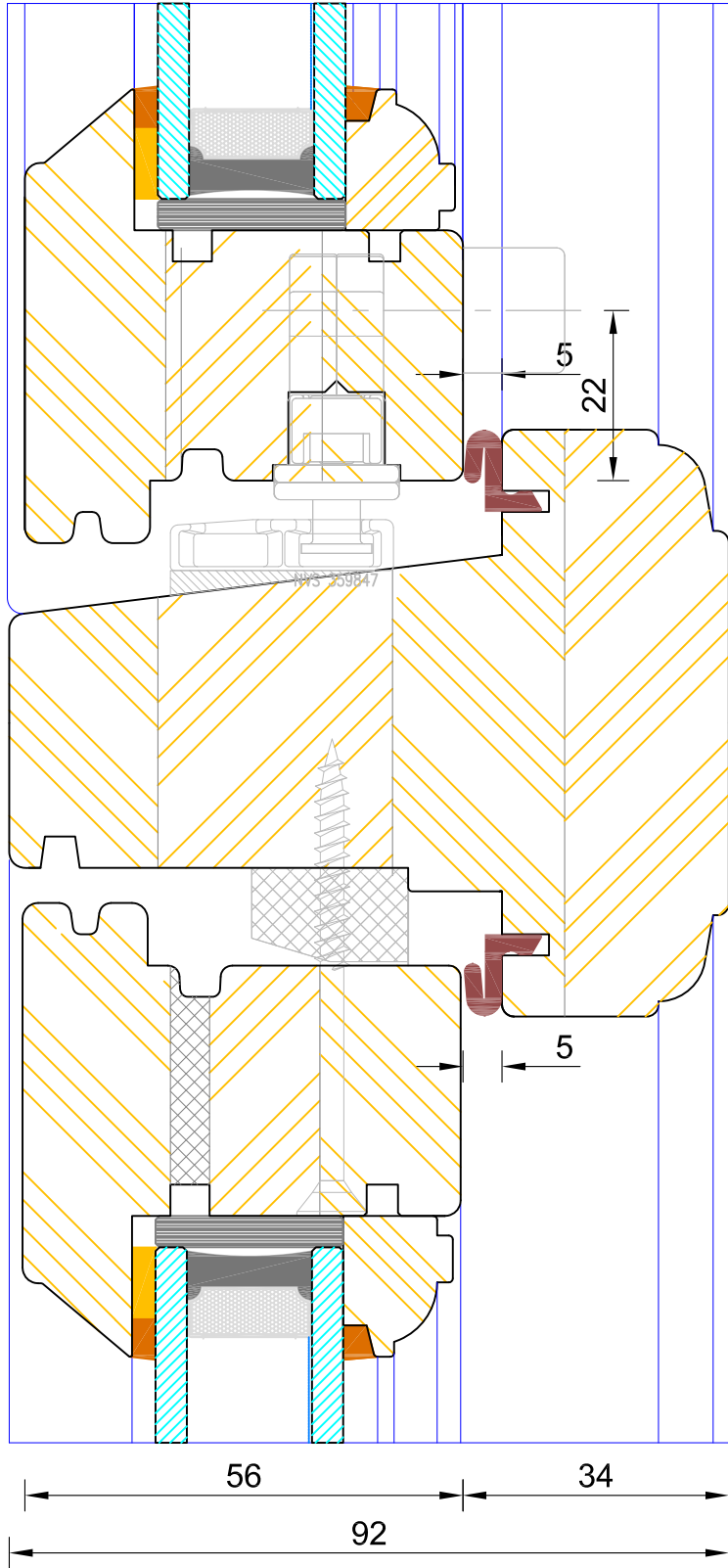
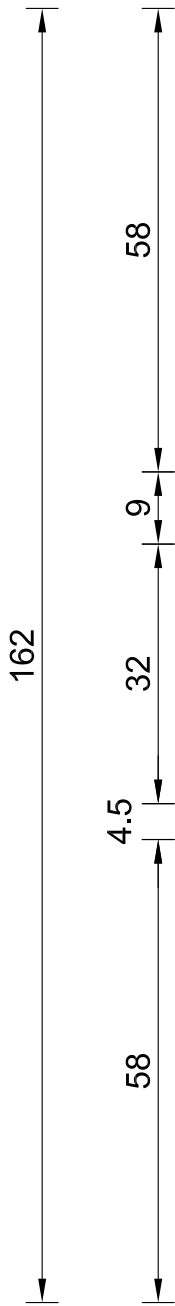
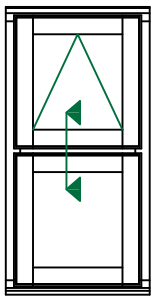

Traditional Flush Casement Window
Solid Transom (Sash / Fixed Sash)

DIMENSIONS	PLOT SIZE	SCALE	DATE	REV	DWG NO.
MM	A4	1:1	15.04.2011	A	1816

Please consider the environment before printing

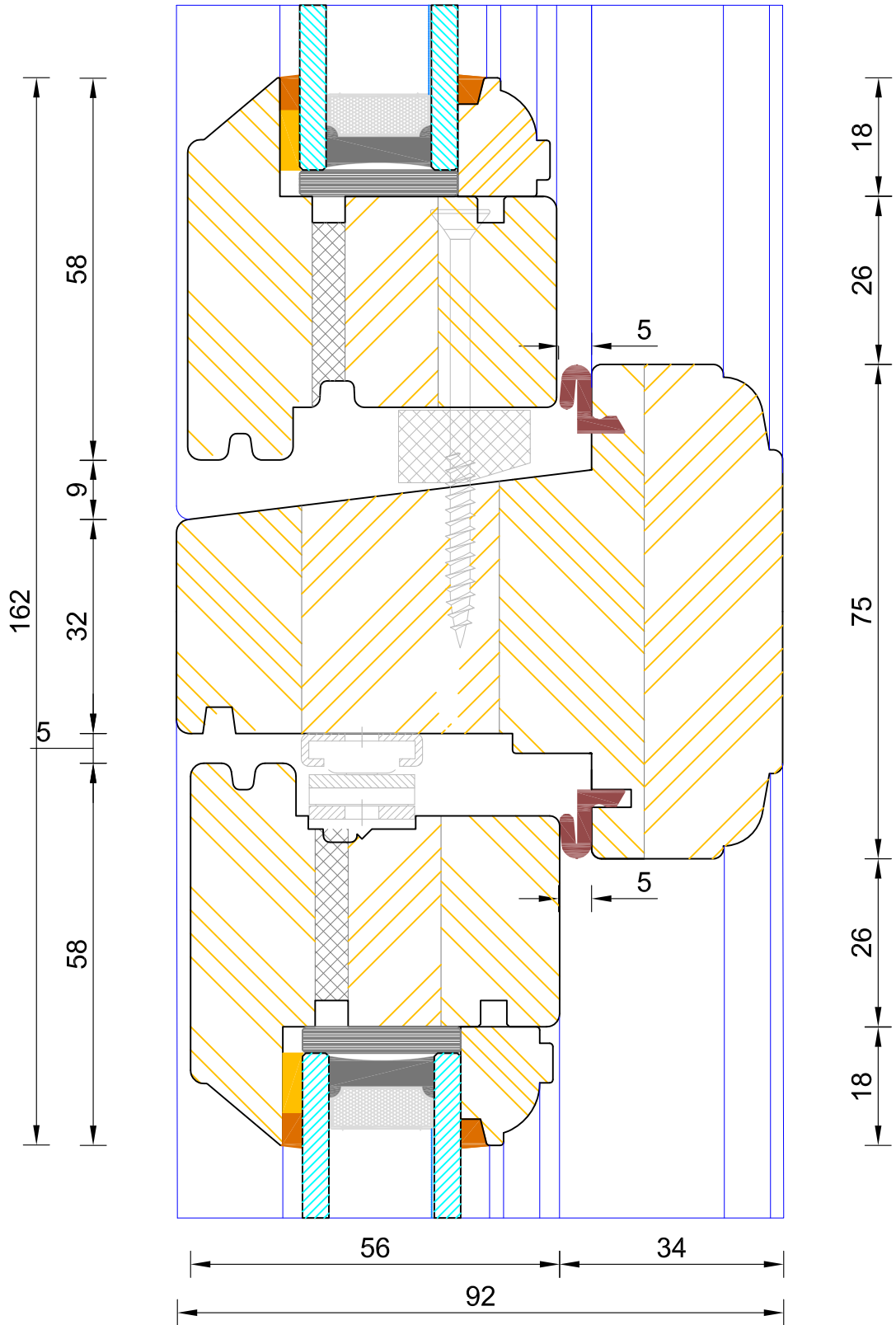
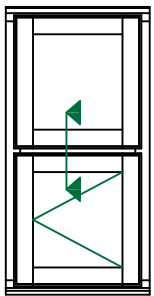

**Traditional Flush Casement Window
Solid Transom (Fixed Sash / Sash)**

DIMENSIONS	PLOT SIZE	SCALE	DATE	REV	DWG NO.
MM	A4	1:1	15.04.2011	A	1815

Please consider the environment before printing

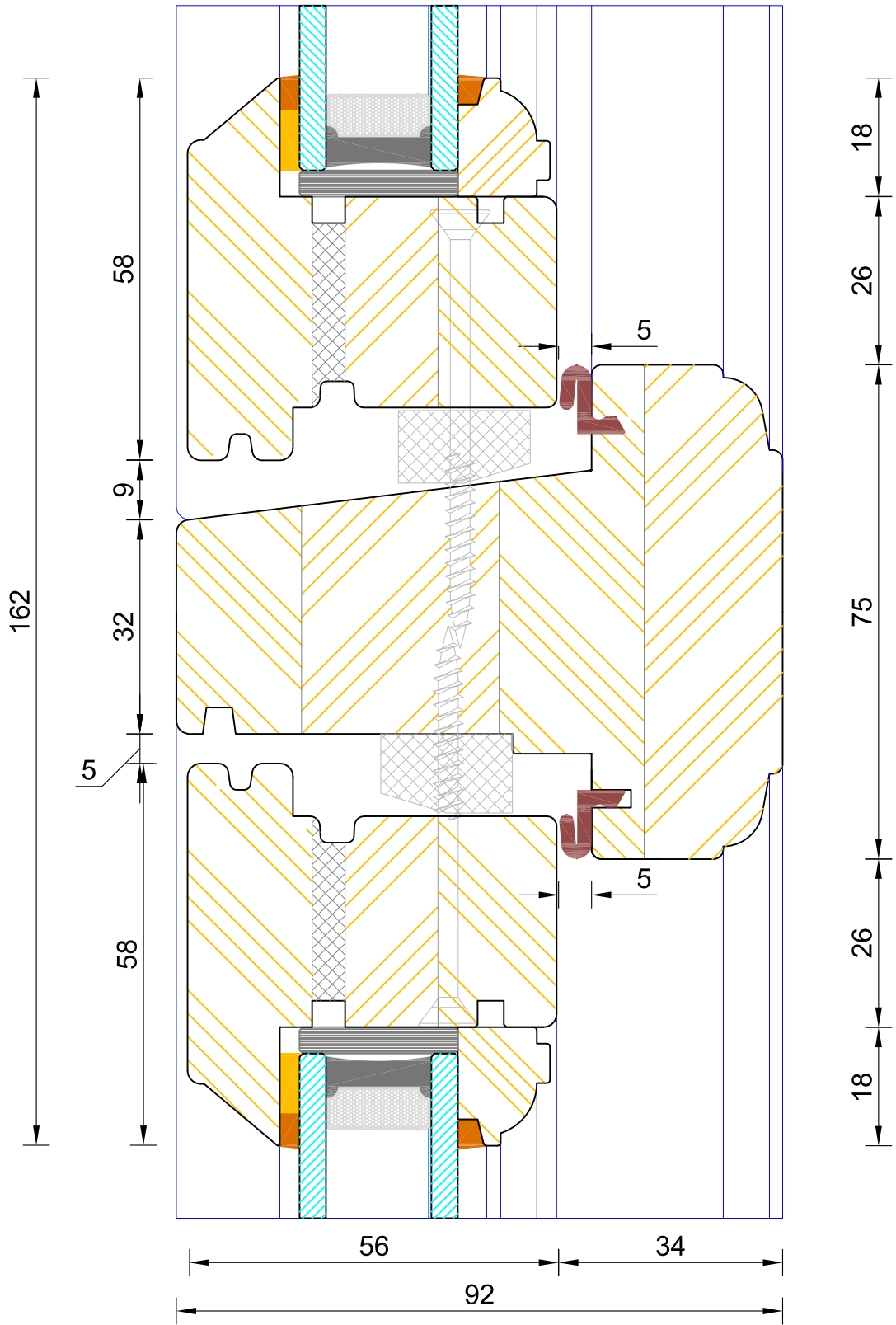
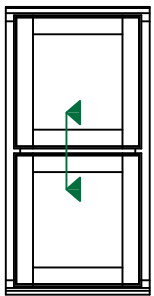

**Traditional Flush Casement Window
Solid Transom (Fixed Sash / Fixed Sash)**

DIMENSIONS	PLOT SIZE	SCALE	DATE	REV	DWG NO.
MM	A4	1:1	15.04.2011	A	1814

Please consider the environment before printing