

OPTIONAL  
no sub cill

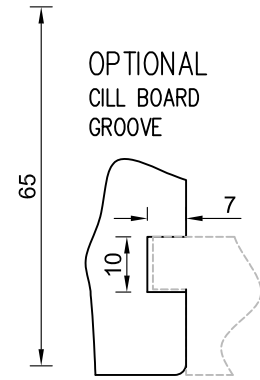
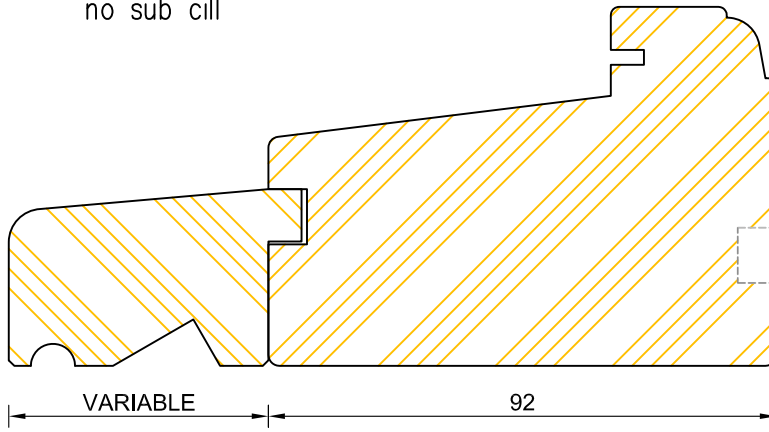

CILL EXTENSION – available options:

- |                      |                       |                       |
|----------------------|-----------------------|-----------------------|
| 25mm (117mm overall) | 87mm (179mm overall)  | 125mm (217mm overall) |
| 47mm (139mm overall) | 100mm (192mm overall) | 140mm (232mm overall) |
| 62mm (154mm overall) | 114mm (205mm overall) |                       |

STANDARD  
one piece subcill

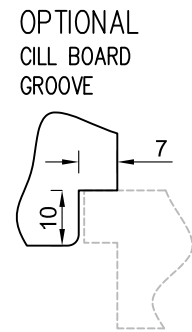
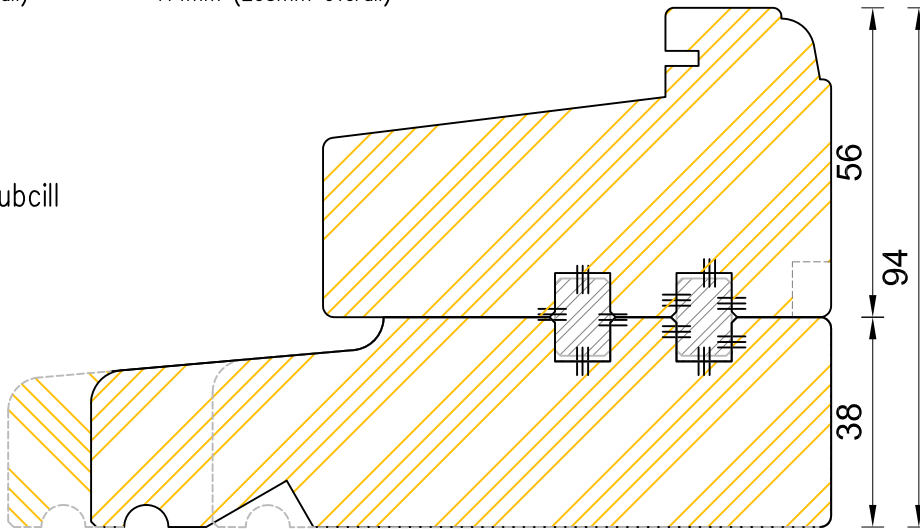

SUBCILL SIZES – 112mm / 134mm / 149mm overall

STANDARD  
subcill with cill extension

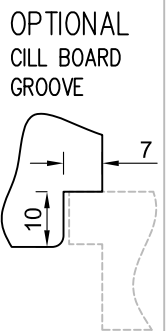
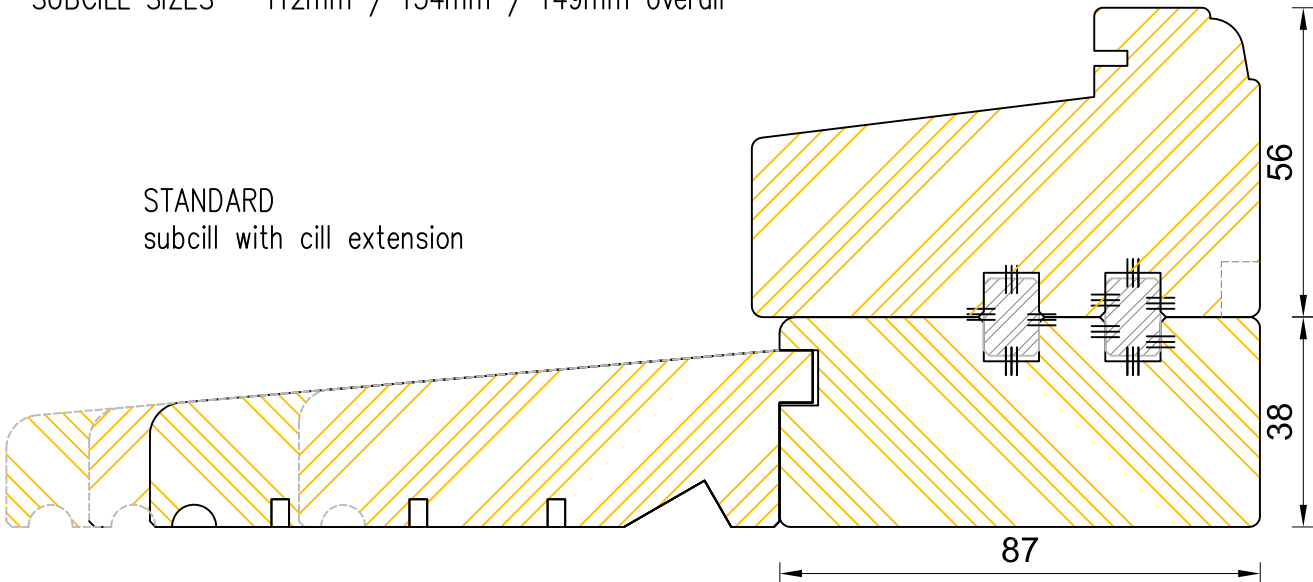

- CILL EXTENSION – available options:
- |                       |
|-----------------------|
| 87mm (174mm overall)  |
| 114mm (201mm overall) |
| 125mm (212mm overall) |
| 140mm (227mm overall) |

### Traditional Flush Casement Window Triple Glazed - Cill Options

DIMENSIONS	PLOT SIZE	SCALE	DATE	REV	DWG NO.
MM	A3	1:1	18.06.2019	B	<b>1842.1</b>

Please consider the environment before printing

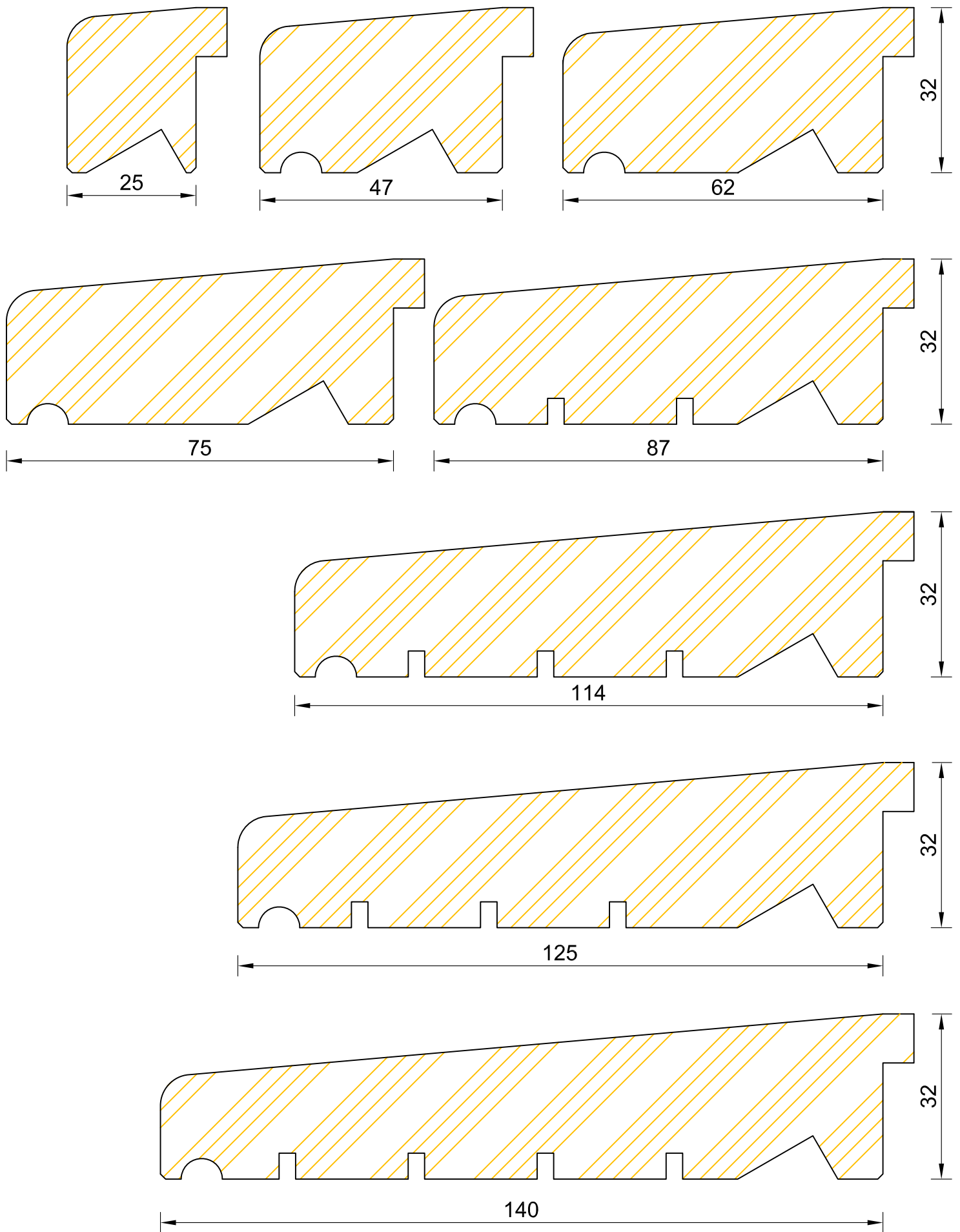

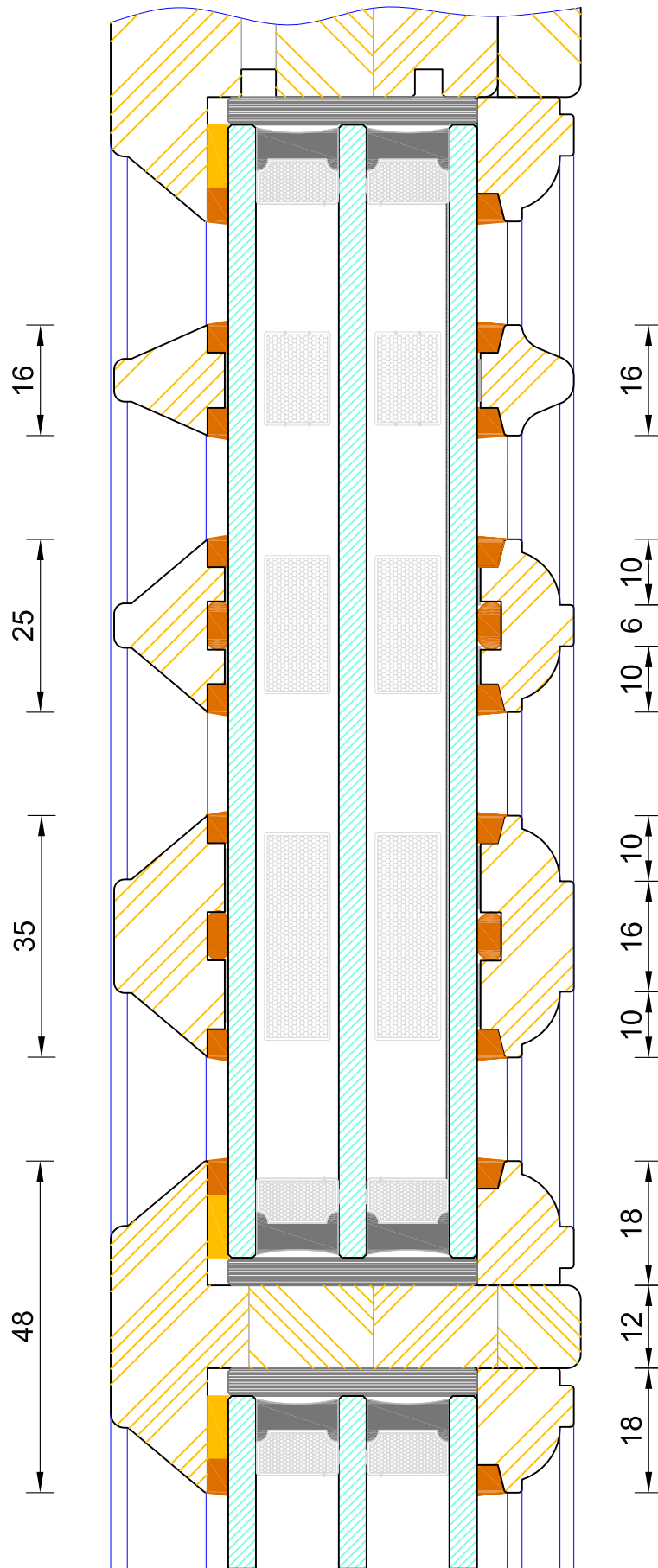

**Traditional Flush Casement Window**  
Triple Glazed - Bar Options

DIMENSIONS	PLOT SIZE	SCALE	DATE	REV	DWG NO.
MM	A4	1:1	18.06.2019	C	<b>1826</b>

HEAD DRIP - Included only if vents are required

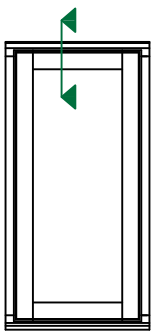
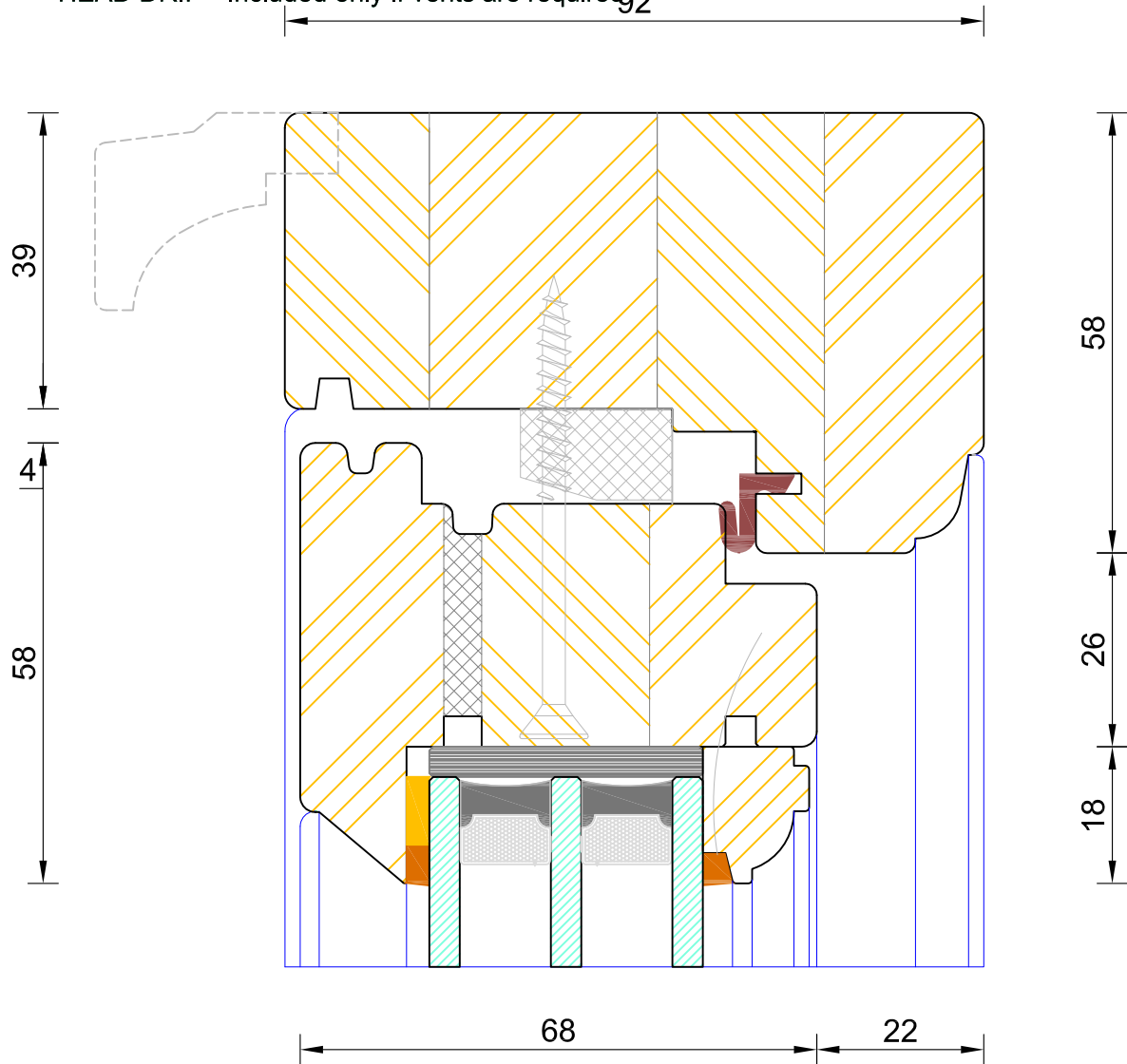

**Traditional Flush Casement Window**  
Triple Glazed - Frame & Sash Head (Fixed Sash)

DIMENSIONS	PLOT SIZE	SCALE	DATE	REV	DWG NO.
MM	A4	1:1	18.06.2019	C	<b>1827</b>
Please consider the environment before printing					



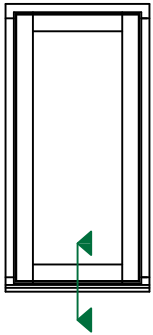
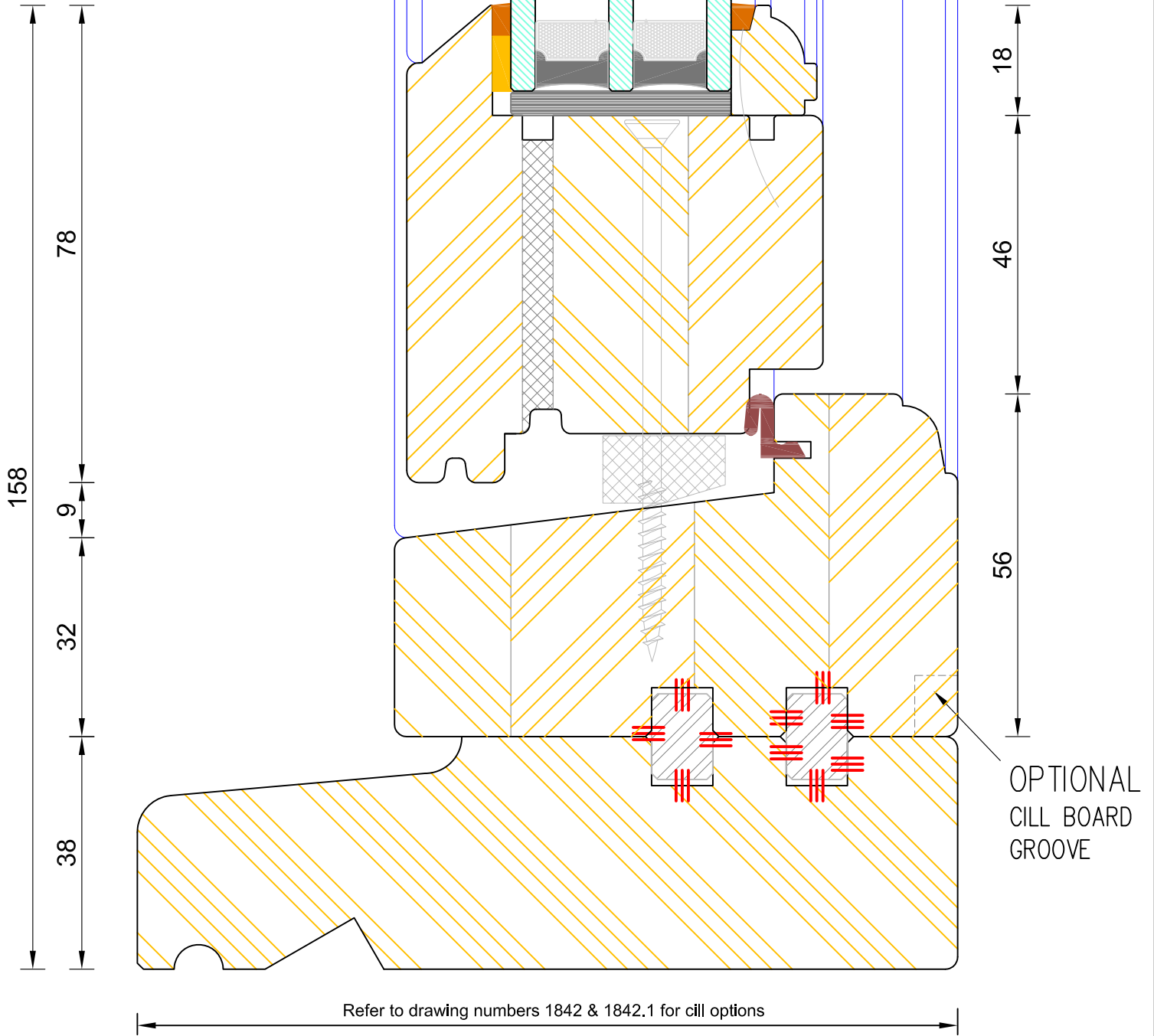

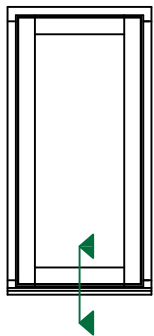
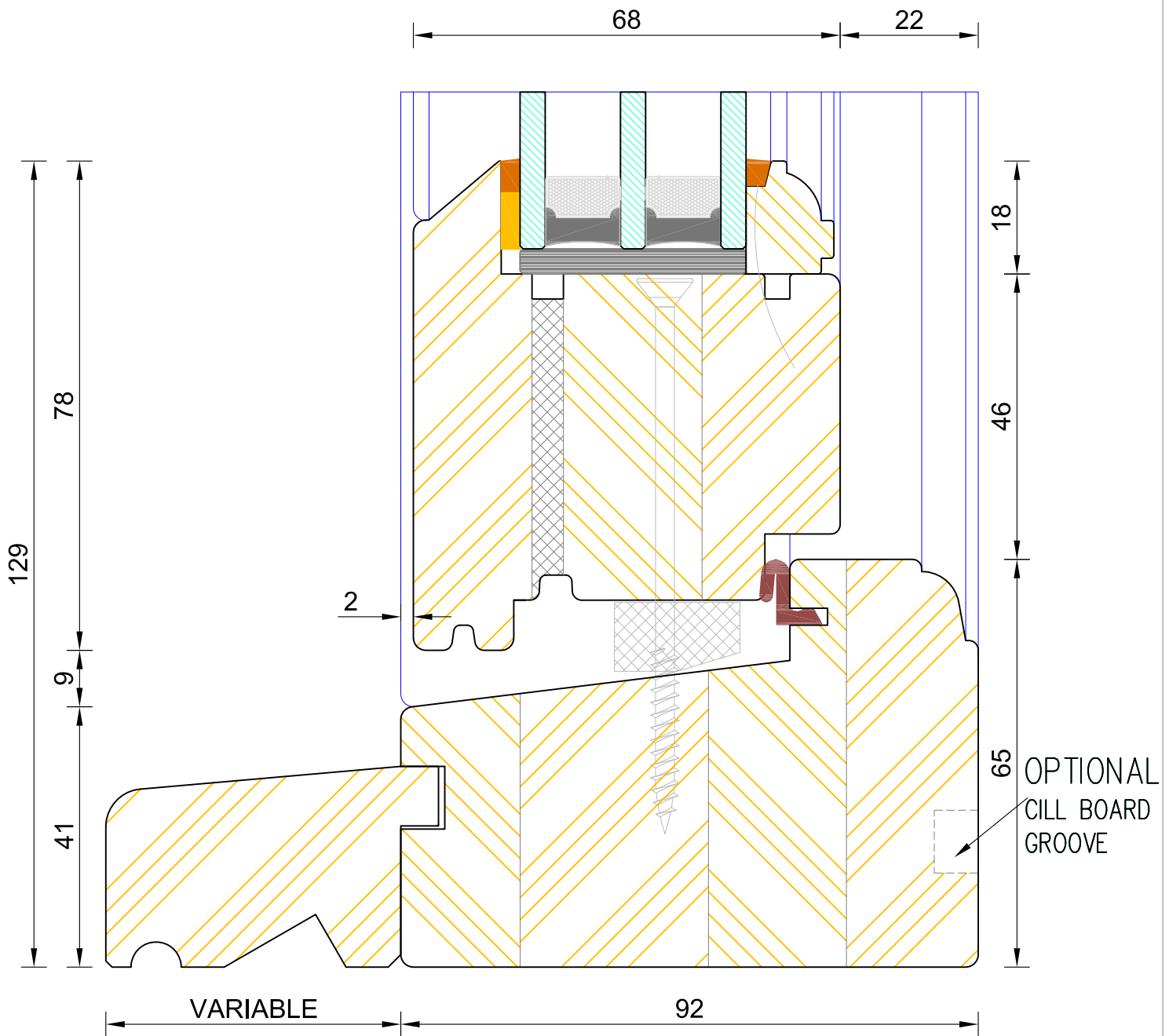

CILL EXTENSION - available options:  
 25mm (112mm o/a) / 47mm (134mm o/a) / 62mm (149mm o/a) /  
 87mm (174mm o/a) / 100mm (192mm o/a) / 114mm (201mm o/a) /  
 125mm (212mm o/a) / 140mm (227mm o/a)

**Traditional Flush Casement Window**  
 Triple Glazed - Frame & Sash Cill (Fixed Sash)

DIMENSIONS	PLOT SIZE	SCALE	DATE	REV	DWG NO.
MM	A4	1:1	18.06.2019	B	<b>1829</b>

Please consider the environment before printing

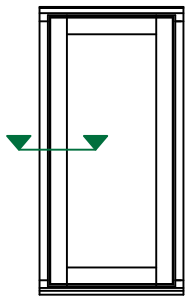
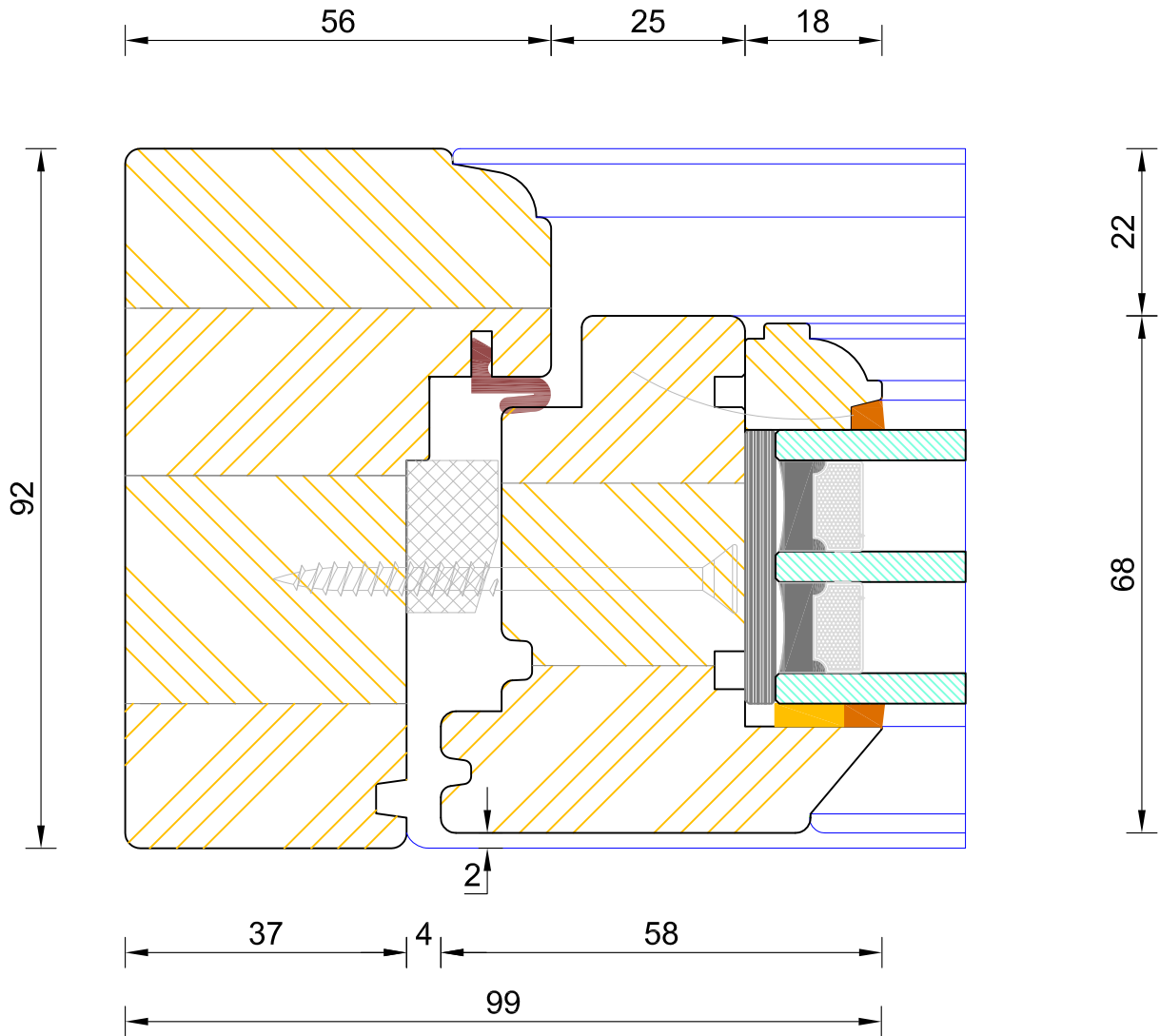

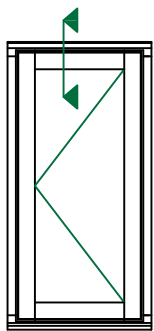
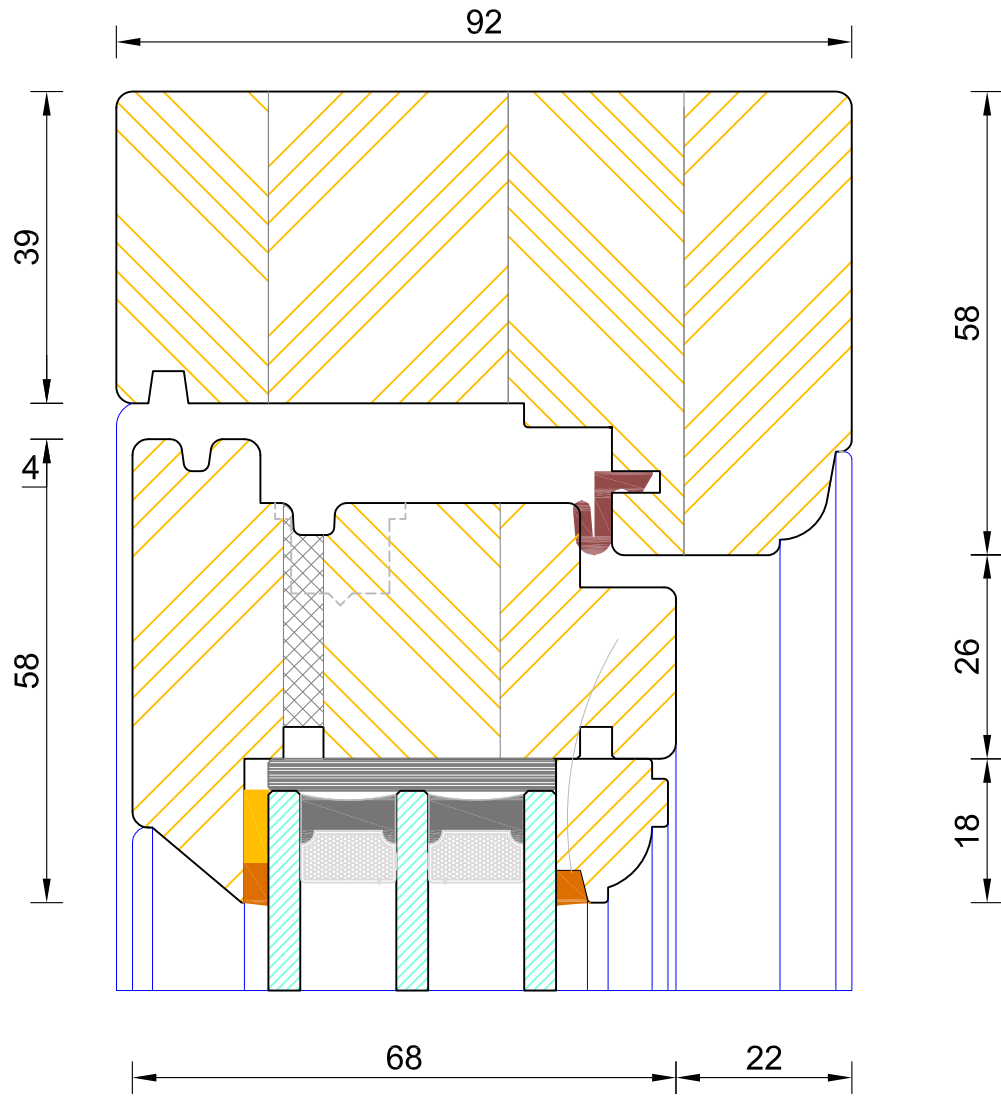

DIMENSIONS	PLOT SIZE	SCALE	DATE	REV	DWG NO.
MM	A4	1:1	18.06.2019	C	<b>1831</b>
Please consider the environment before printing					



HEAD DRIP - Included only if vents are required

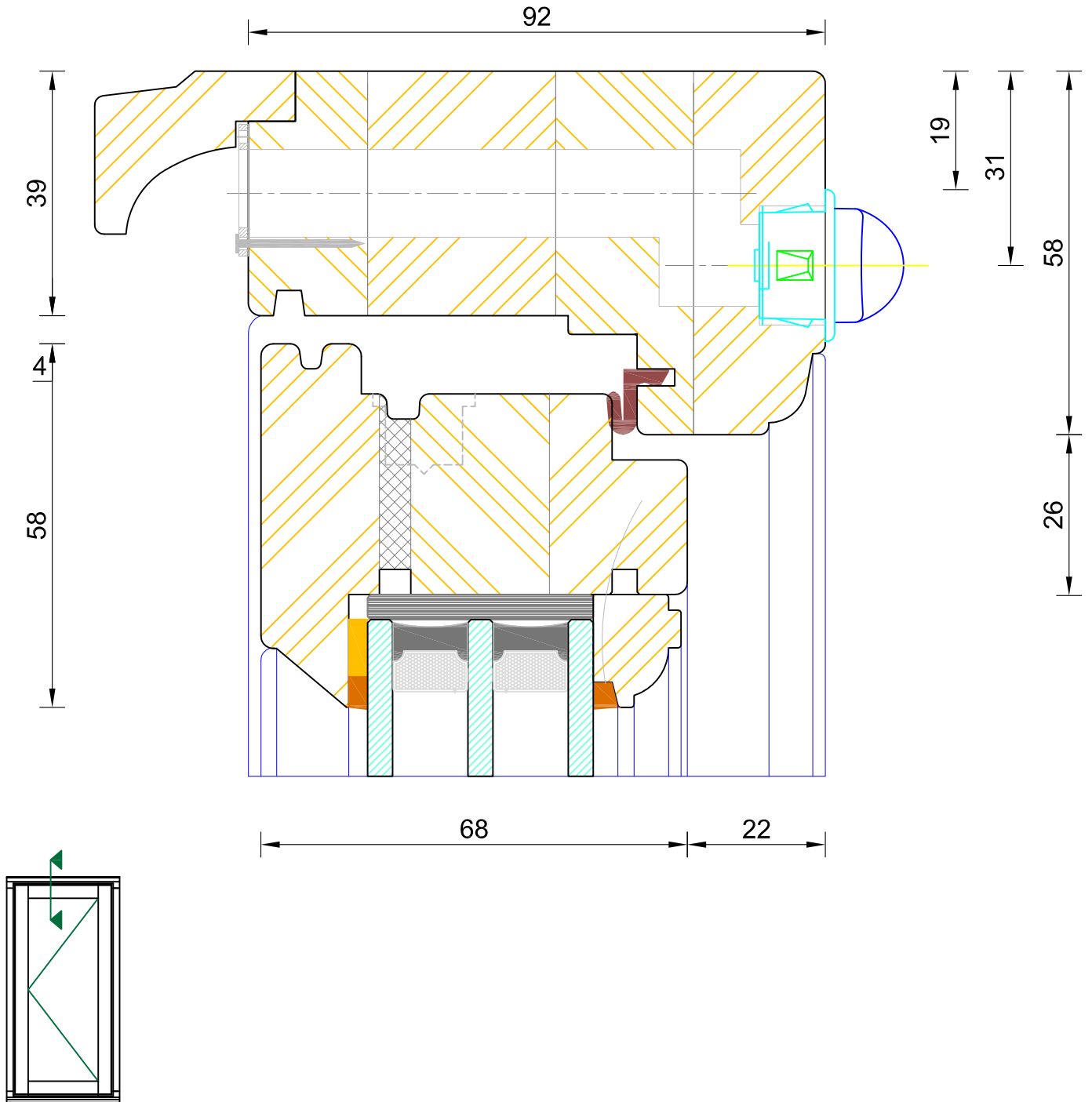

### Traditional Flush Casement Window

Triple Glazed - Frame & Sash Head (Standard 58mm Head With Vent)

DIMENSIONS	PLOT SIZE	SCALE	DATE	REV	DWG NO.
MM	A4	1:1	18.06.2019	A	<b>1831.1</b>
Please consider the environment before printing					

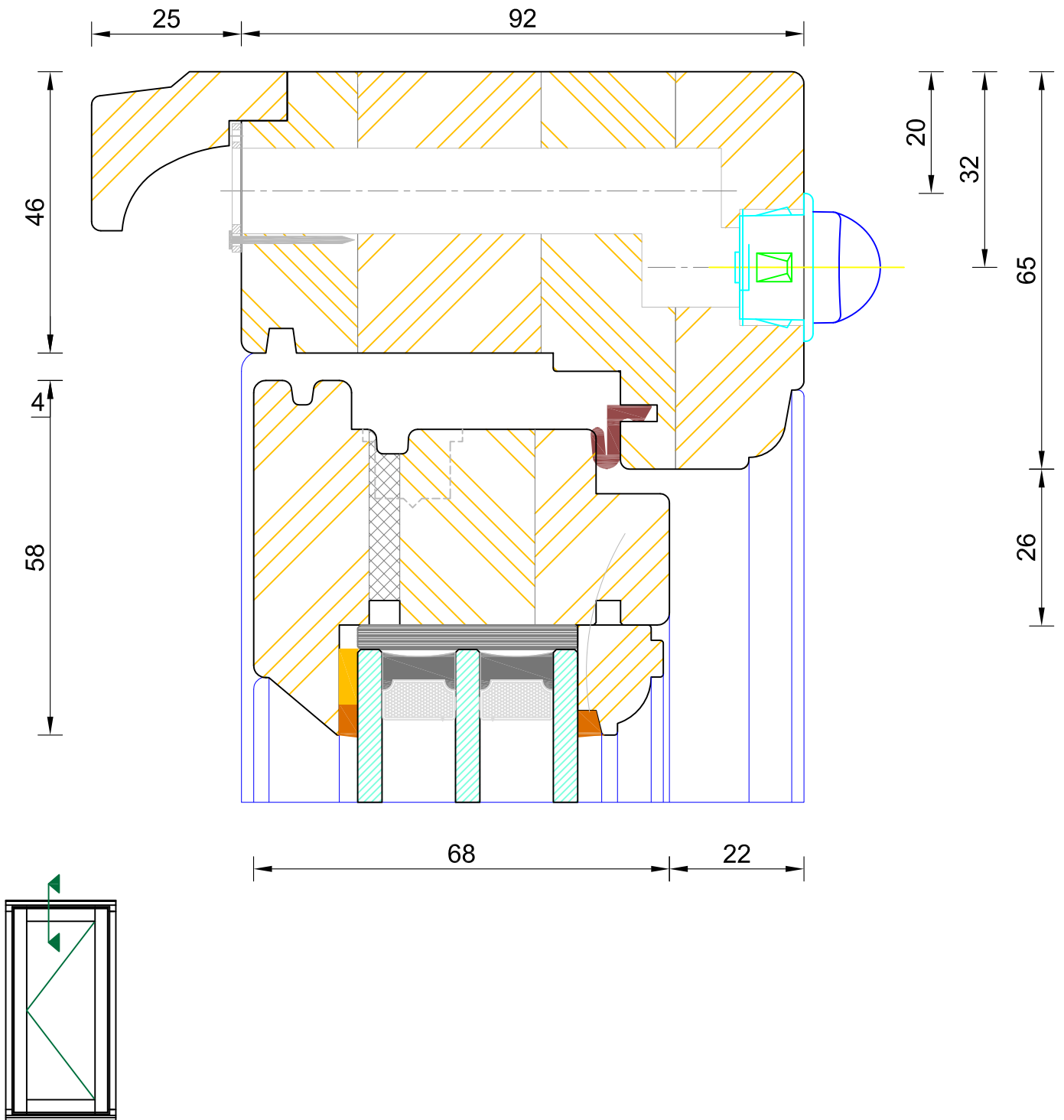

### Traditional Flush Casement Window

Triple Glazed - Frame & Sash Head (Optional 65mm Head With Vent)

DIMENSIONS	PLOT SIZE	SCALE	DATE	REV	DWG NO.
MM	A4	1:1	18.06.2019	C	<b>1833</b>

Please consider the environment before printing

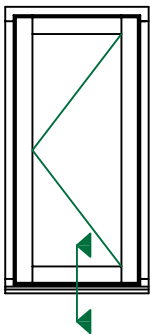
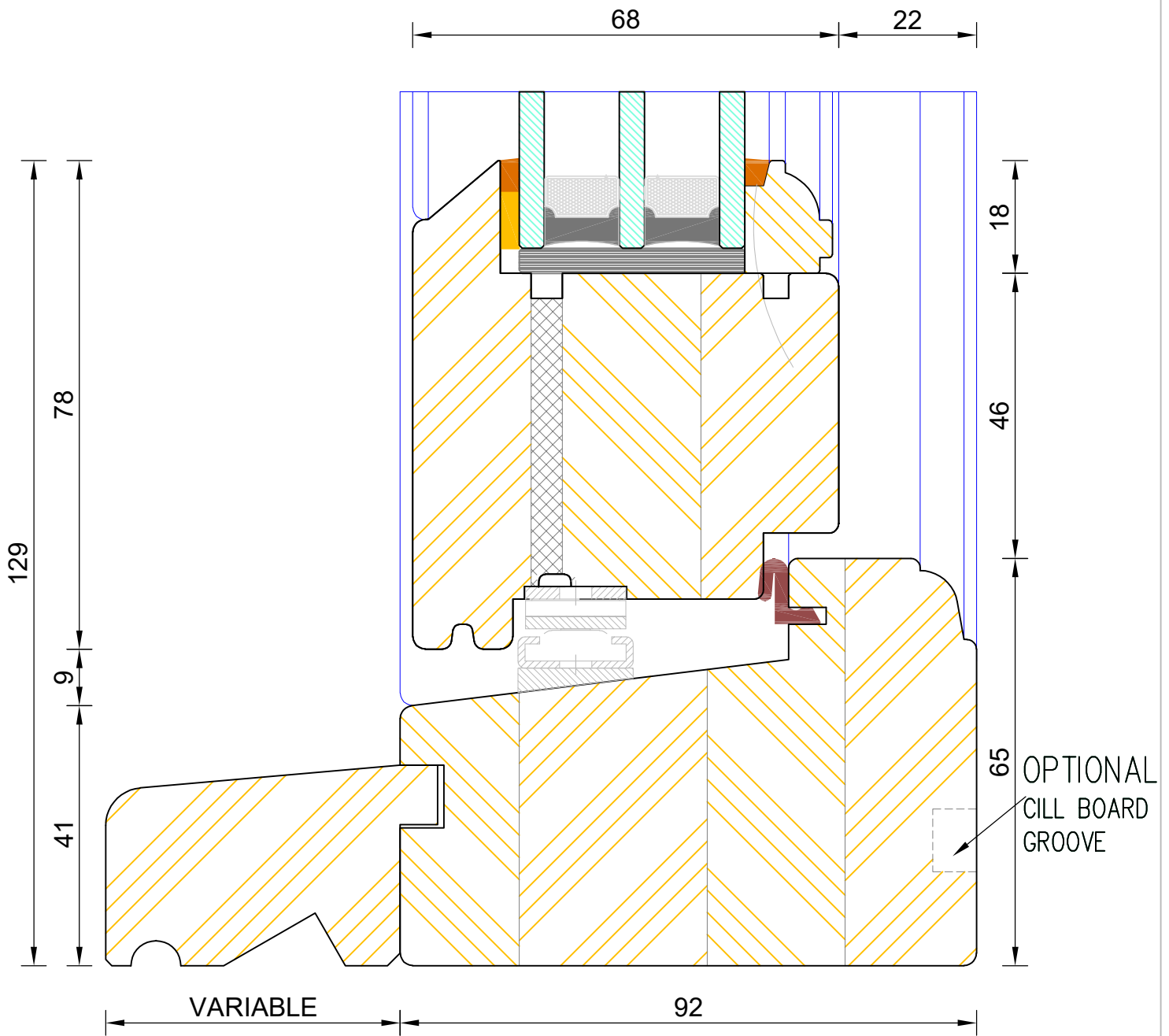

CILL EXTENSION - available options:

- 25mm (112mm o/a) / 47mm (134mm o/a) / 62mm (149mm o/a) /
- 87mm (174mm o/a) / 100mm (192mm o/a) / 114mm (201mm o/a) /
- 125mm (212mm o/a) / 140mm (227mm o/a)



**Traditional Flush Casement Window**  
Triple Glazed - Frame & Sash Cill (& Easy Clean Hinge)

DIMENSIONS	PLOT SIZE	SCALE	DATE	REV	DWG NO.
MM	A4	1:1	18.06.2019	B	<b>1835.2</b>

Please consider the environment before printing

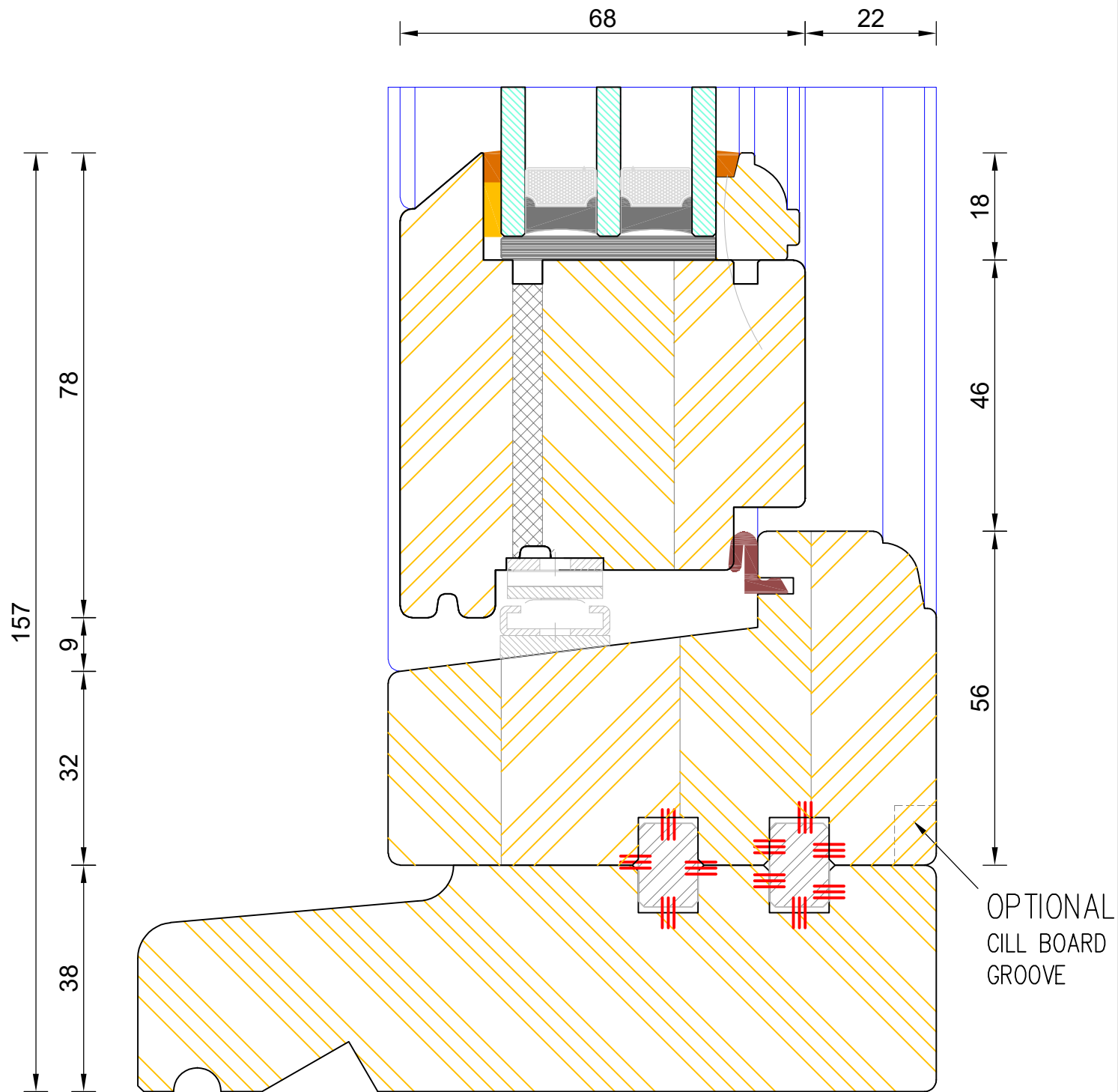

Refer to drawing numbers 1842 & 1842.1 for cill options

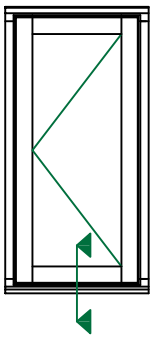

**Traditional Flush Casement Window**  
 Triple Glazed - Frame & Sash Cill (With Subcill & Easy Clean Hinge)

DIMENSIONS	PLOT SIZE	SCALE	DATE	REV	DWG NO.
MM	A4	1:1	18.06.2019	B	<b>1835.1</b>

Please consider the environment before printing

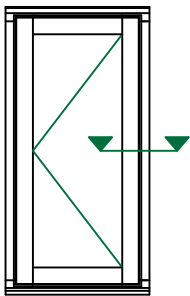
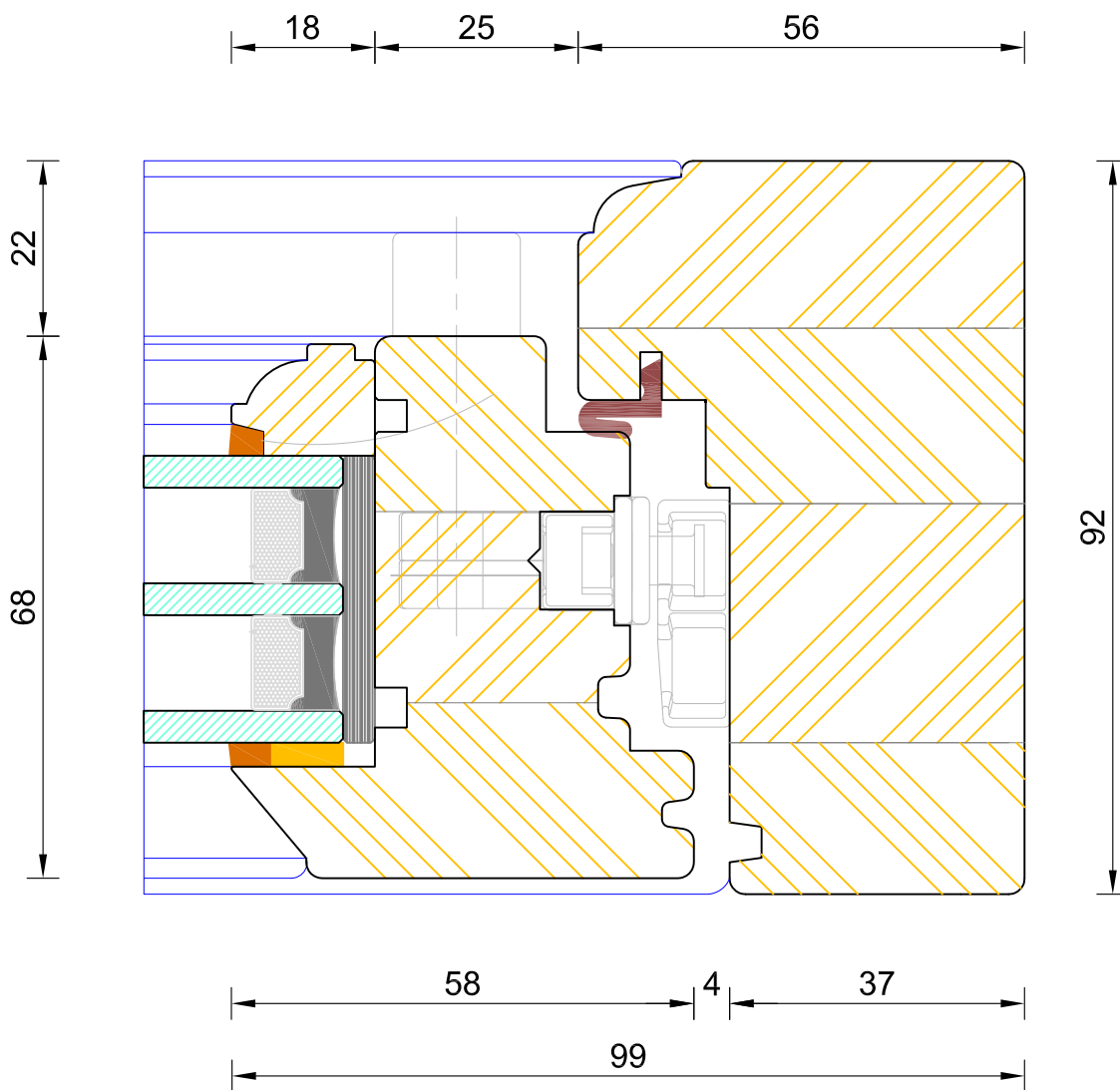

**Traditional Flush Casement Window**  
Triple Glazed - Frame & Sash Jamb (handle Side)

DIMENSIONS	PLOT SIZE	SCALE	DATE	REV	DWG NO.
MM	A4	1:1	18.06.2019	B	<b>1836</b>
Please consider the environment before printing					

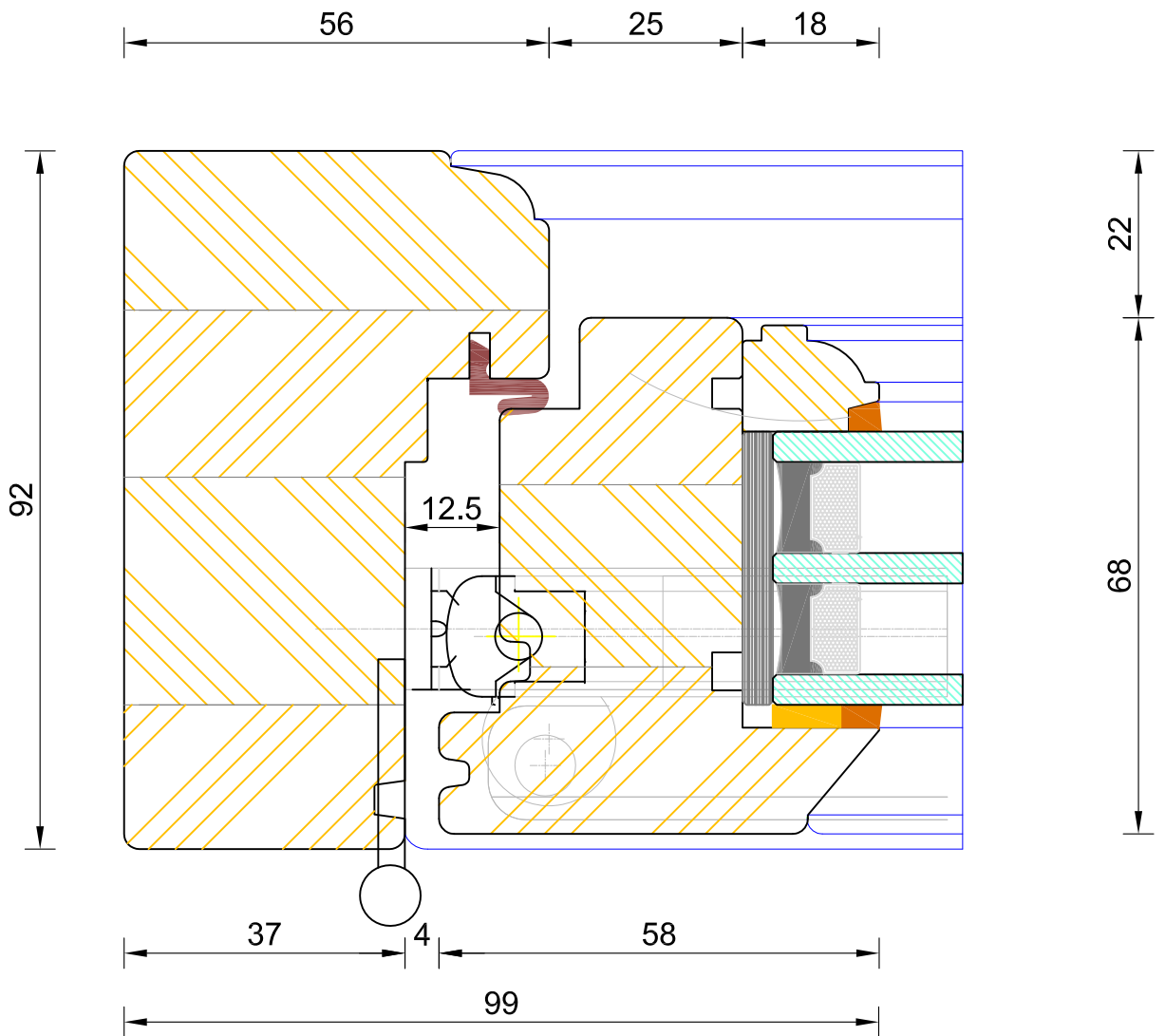

Note:  
 Jamb section shown with GU Hinge  
 Dummy Butt Hinge - Optional

Available Hinge Options  
 GU (as shown) Dummy Butt Hinge Optional  
 Easy Clean  
 Egress Easy Clean  
 Casp  
 Defender Plus

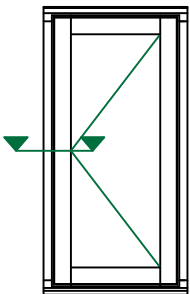

**Traditional Flush Casement Window**  
 Triple Glazed - Frame & Sash Jamb (Hinge Side)

DIMENSIONS	PLOT SIZE	SCALE	DATE	REV	DWG NO.
MM	A4	1:1	18.06.2019	B	<b>1837</b>
Please consider the environment before printing					



# Bereco

## Traditional Flush Casement Window Triple Glazed - Solid Mullion (Fixed Sash / Sash )

DIMENSIONS	PLOT SIZE	SCALE	DATE	REV	DWG. NO.
MM	A4	1:1	18.06.2019	B	<b>1838</b>

Please consider the environment before printing

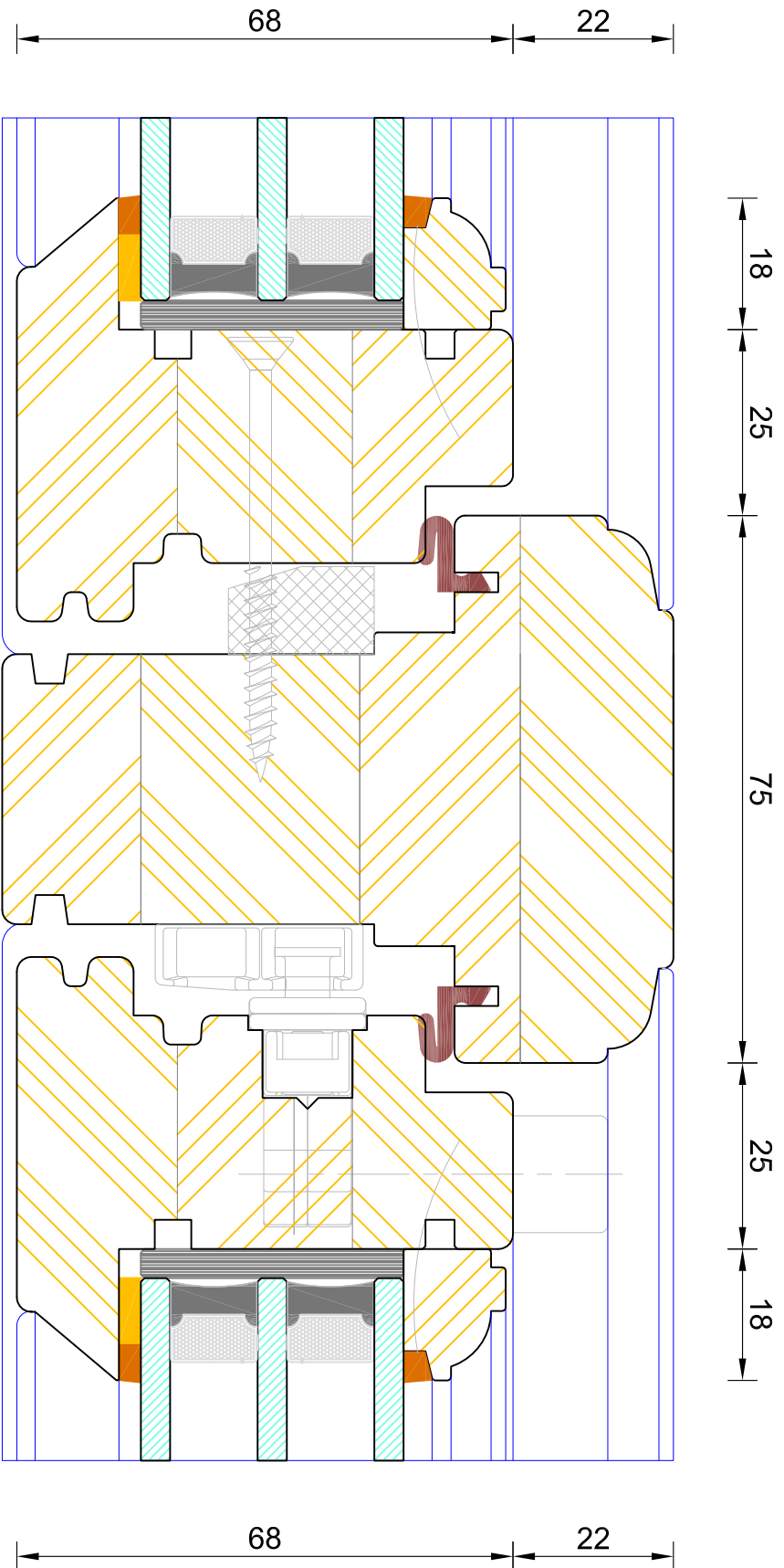
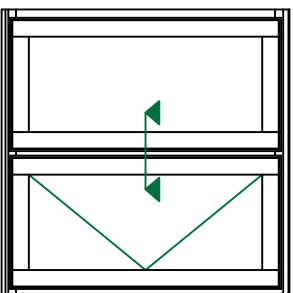



# Bereco

## Traditional Flush Casement Window Triple Glazed - Solid Mullion (Sash / Sash )

DIMENSIONS		PLOT SIZE	SCALE	DATE	REV	DWG. NO.
MM	A4	A4	1:1	18.06.2019	B	<b>1839</b>

Please consider the environment before printing

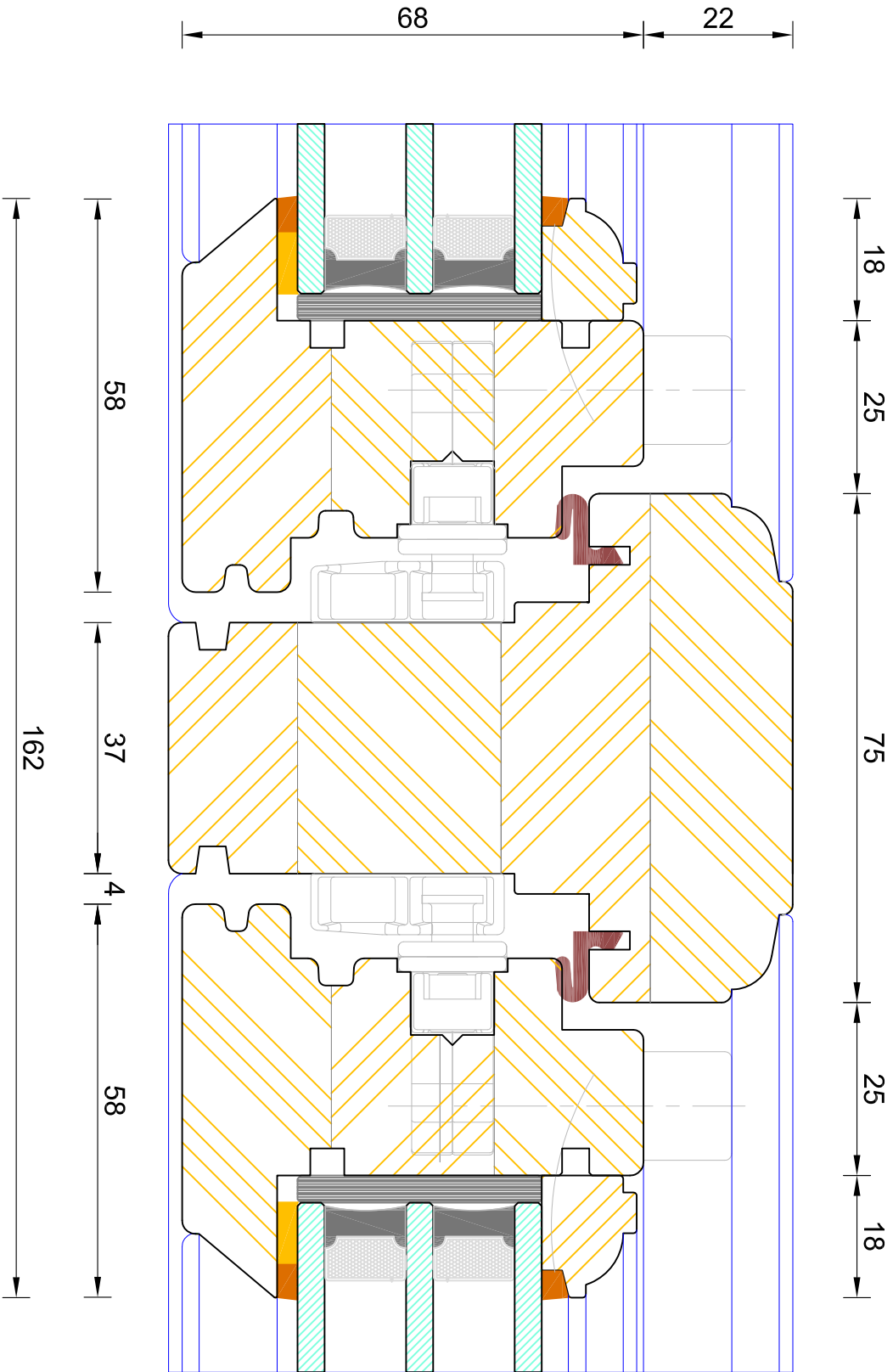
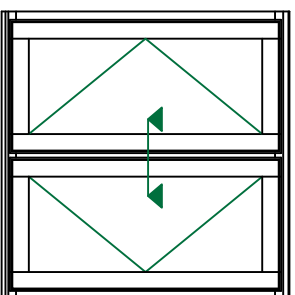





# Bereco

## Traditional Flush Casement Window Triple Glazed - Solid Mullion (Fixed Sash / Fixed Sash )

DIMENSIONS	PLOT SIZE	SCALE	DATE	REV	DWG. NO.
MM	A4	1:1	18.06.2019	B	<b>1840</b>

Please consider the environment before printing

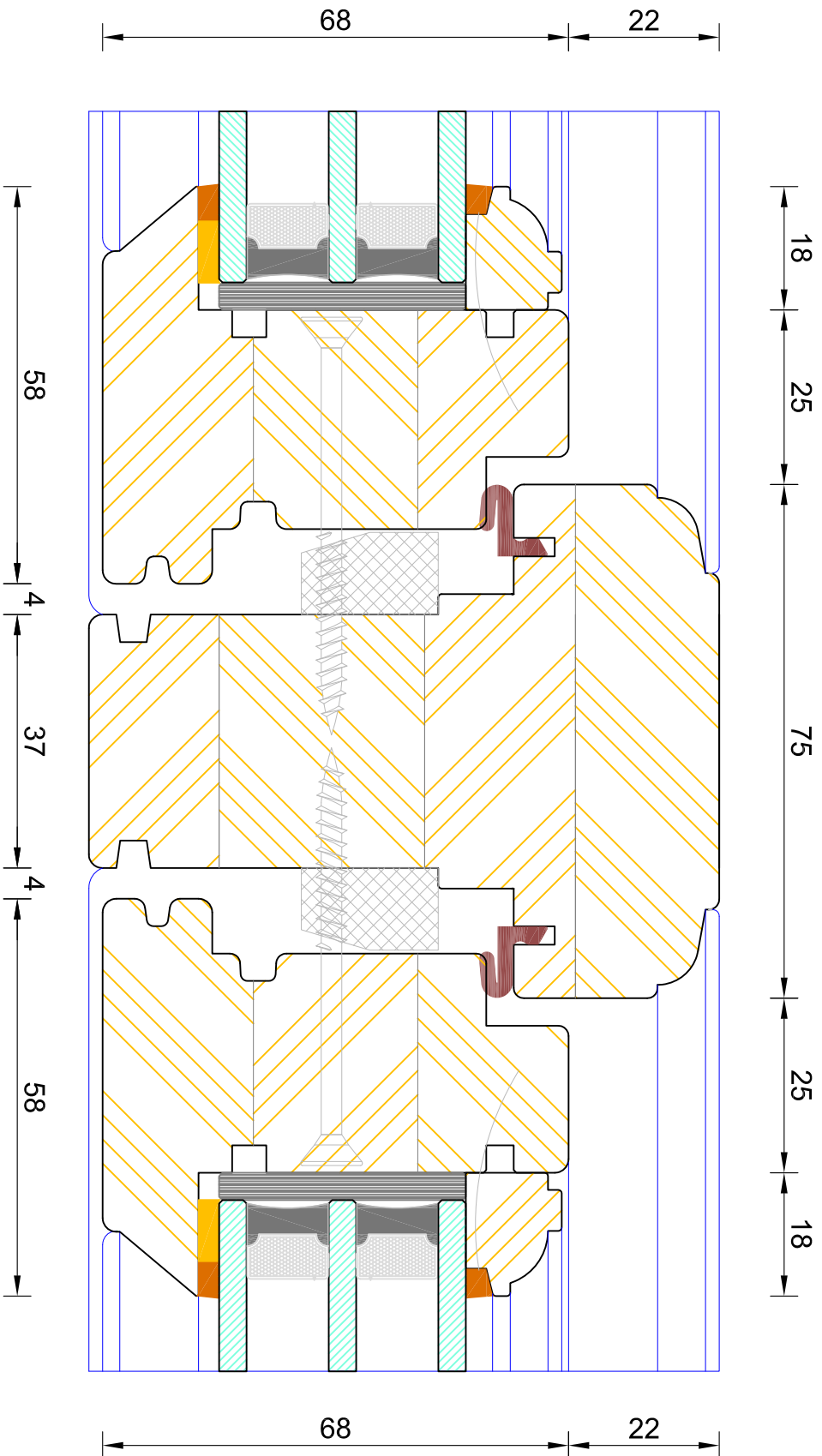
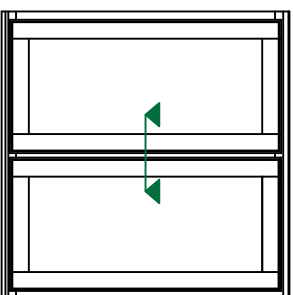



# Bereco

## Traditional Flush Casement Window Triple Glazed - Flying Mullion (Lead / Slave Sash )

DIMENSIONS		PLOT SIZE	SCALE	DATE	REV	DWG. NO.
MM	A4	A4	1:1	18.06.2019	B	<b>18411</b>

Please consider the environment before printing

