

**Traditional Sliding Sash Spiral Balance**  
Triple Glazed - Cill Extension Options

DIMENSIONS	PLOT SIZE	SCALE	DATE	REV	DWG NO.
MM	A4	1:1	15.10.2019	B	<b>2031</b>

Please consider the environment before printing

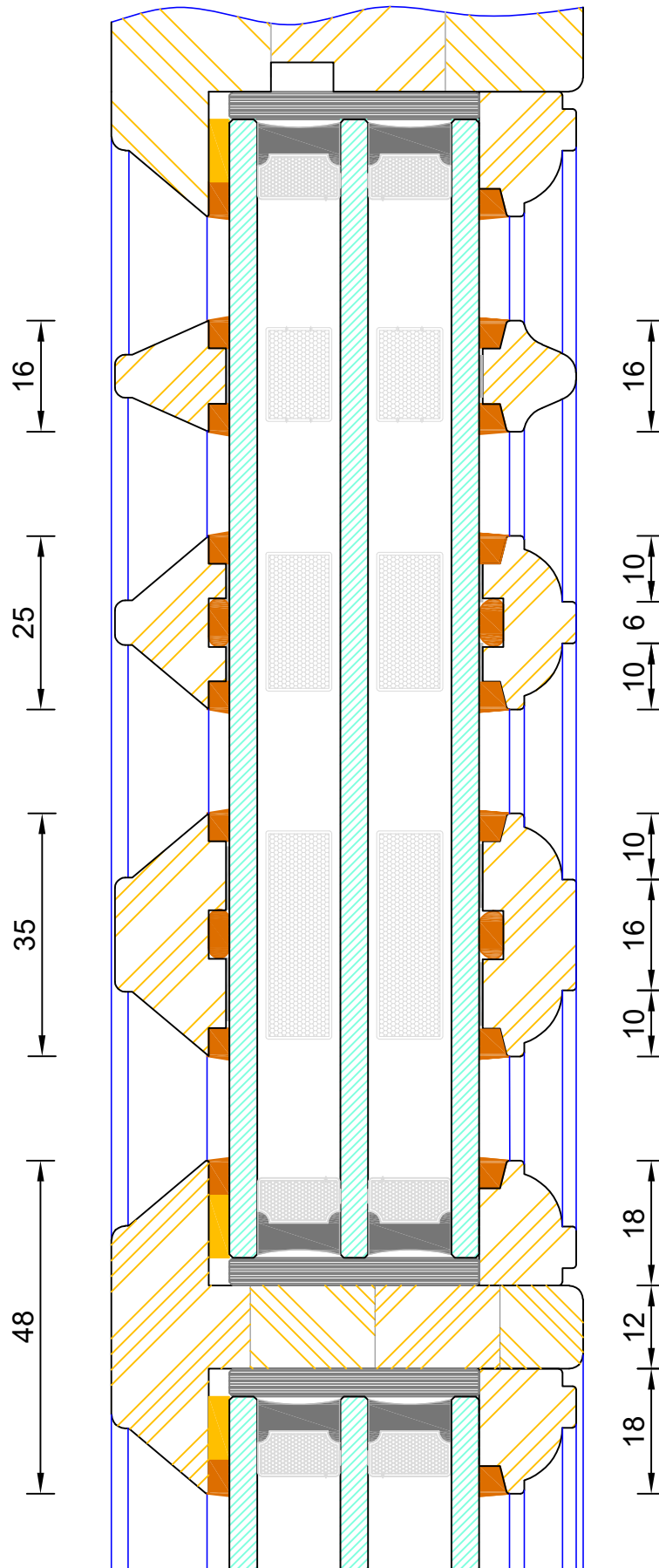

DIMENSIONS	PLOT SIZE	SCALE	DATE	REV	DWG NO.
MM	A4	1:1	01.01.2019	B	<b>2027</b>



# Berenco

## Traditional Sliding Sash Spiral Balance Triple Glazed - Frame & Sash Head (With Vent)

DIMENSIONS	PLOT SIZE	SCALE	DATE	REV	DWG NO.
MM	A1	1:1	08.08.2022	B	2022

Please consider the environment before printing

Note: Detail Used  
1/ If order has vents specified

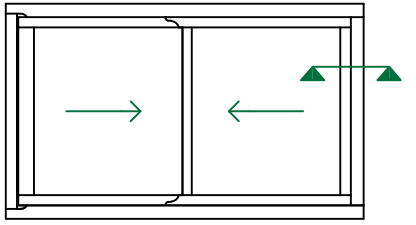

45 54

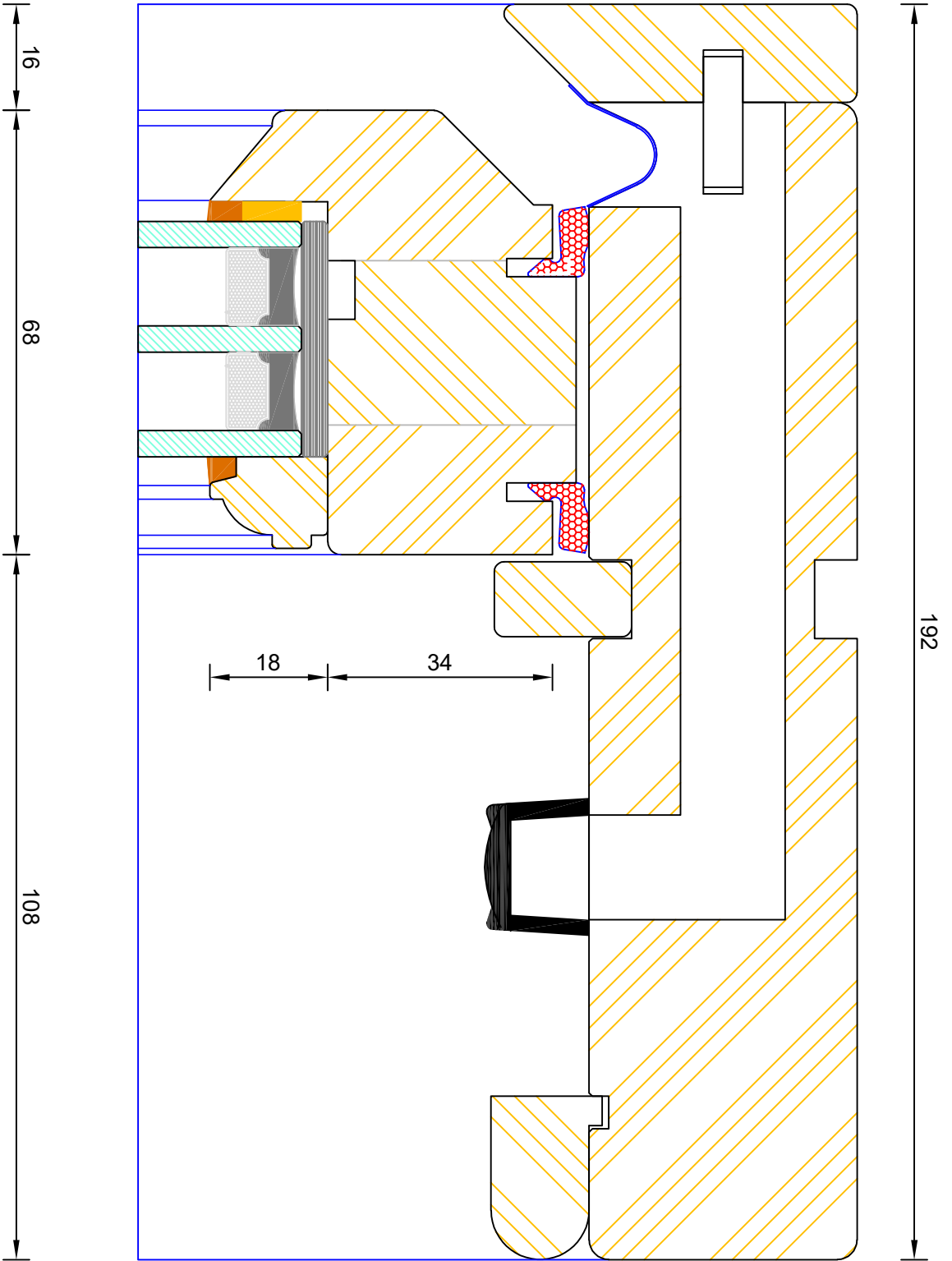

16

68

108

192

18

34

15

41



# Berenco

## Traditional Sliding Sash Spiral Balance Triple Glazed - Frame & Sash Cill

DIMENSIONS	PLOT SIZE	SCALE	DATE	REV	DWG. NO.
MM	A1	1:1	08.08.2022	B	

Please consider the environment before printing

**2023**

**CILL EXTENSION - available options:**  
 25mm (193mm o/a) / 47mm (215mm o/a) /  
 62mm (230mm o/a) / 87mm (255mm o/a) /  
 100mm (268mm o/a) / 114mm (282mm o/a) /  
 140mm (308mm o/a)

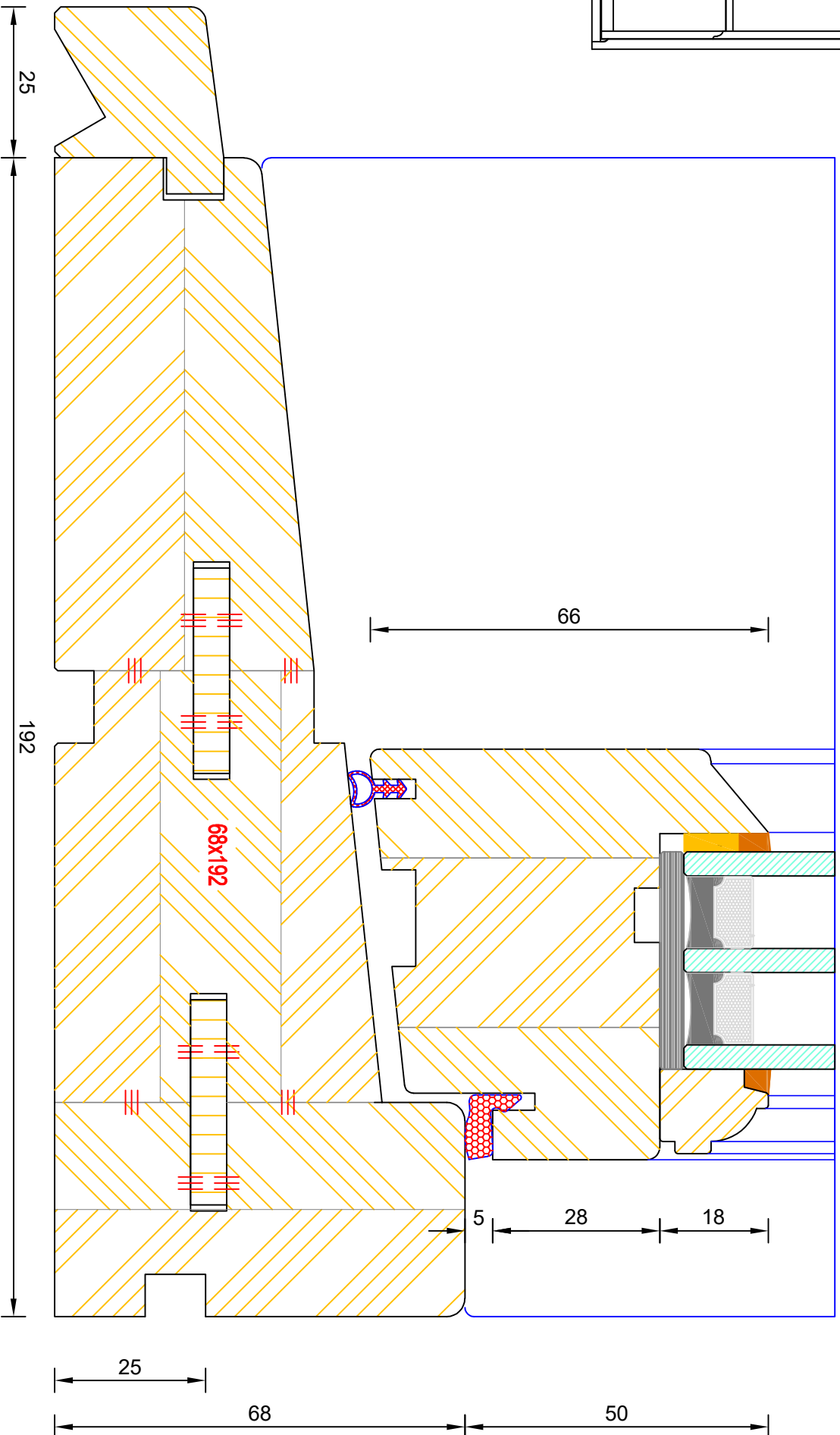

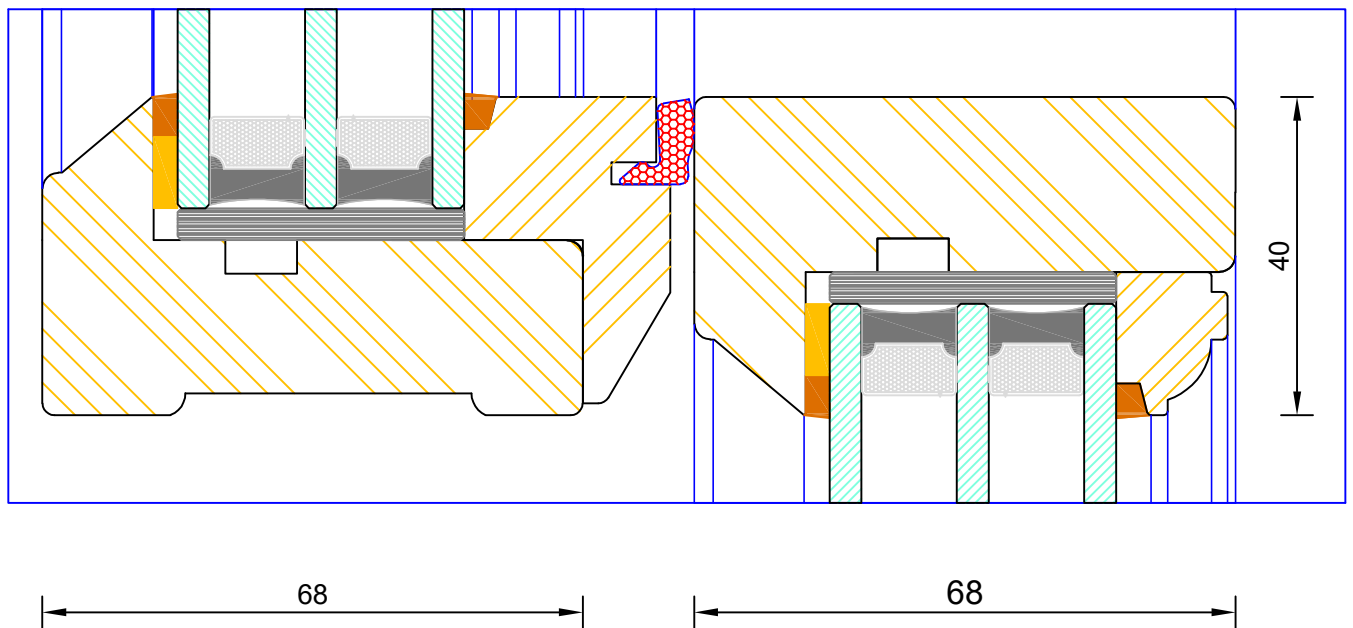
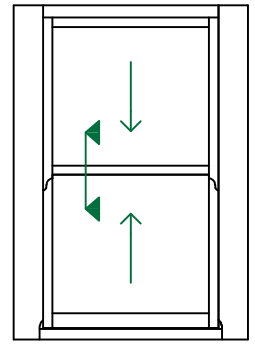

REFER TO DOUBLE GLAZED  
SECTIONS FOR VENT AND ANGEL  
LOCK POSITIONS & HORN PROFILES



**Traditional Sliding Sash Spiral Balance  
Triple Glazed - Meeting Rail**

DIMENSIONS	PLOT SIZE	SCALE	DATE	REV	DWG NO.
MM	A4	1:1	08.08.2022	B	<b>2024</b>

Please consider the environment before printing

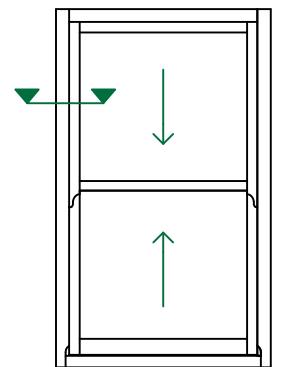
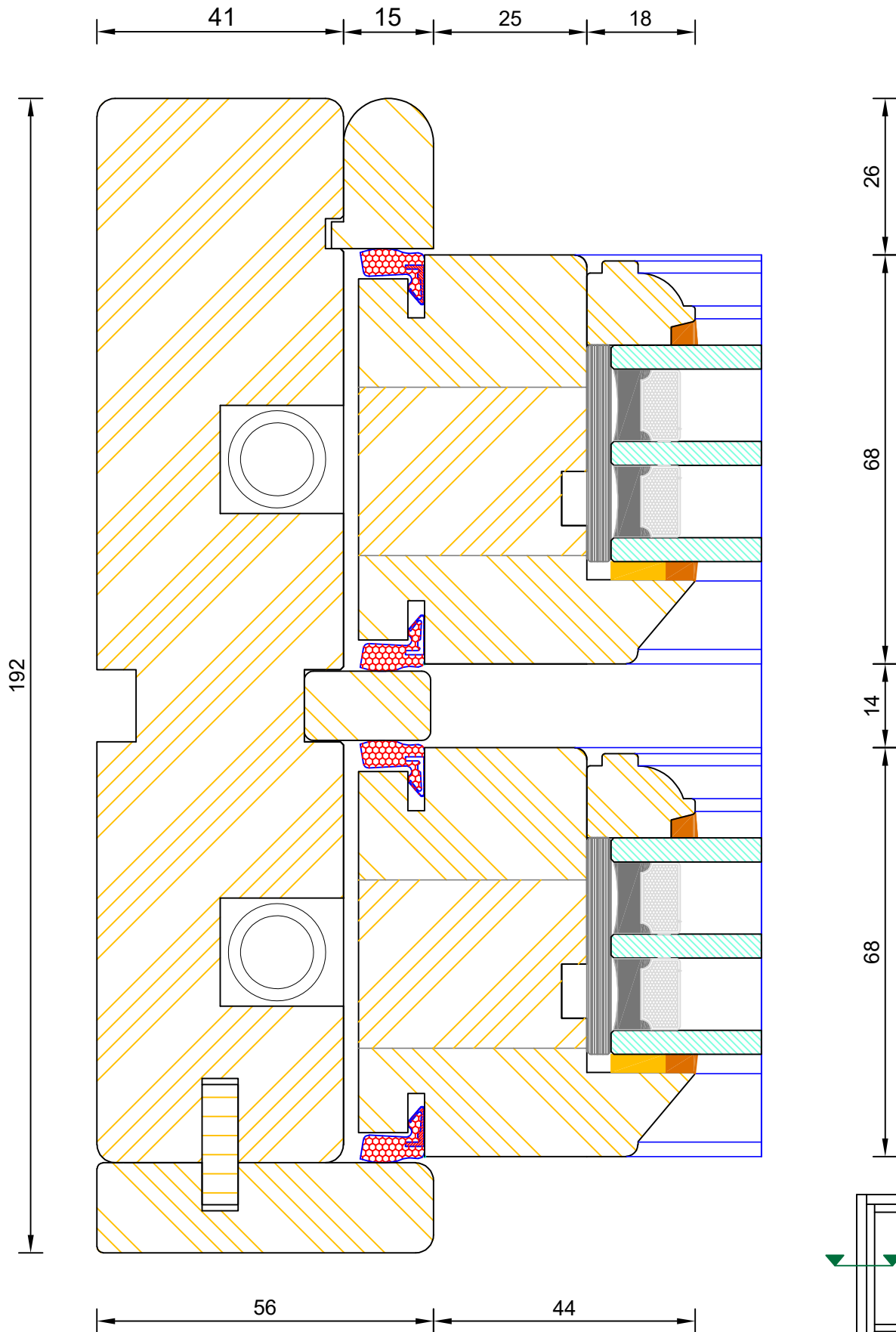

**Traditional Sliding Sash Spiral Balance**  
Triple Glazed - Frame & Sash Jamb (Standard Inline)

DIMENSIONS	PLOT SIZE	SCALE	DATE	REV	DWG NO.
MM	A4	1:1	08.08.2022	B	<b>2026</b>

Please consider the environment before printing