

Traditional Open Out Lipped French Door Cill Extension Options

DIMENSIONS	PLOT SIZE	SCALE	DATE	REV	DWG NO.
MM	A4	1:1	25.09.2019	B	2201
Please consider the environment before printing					

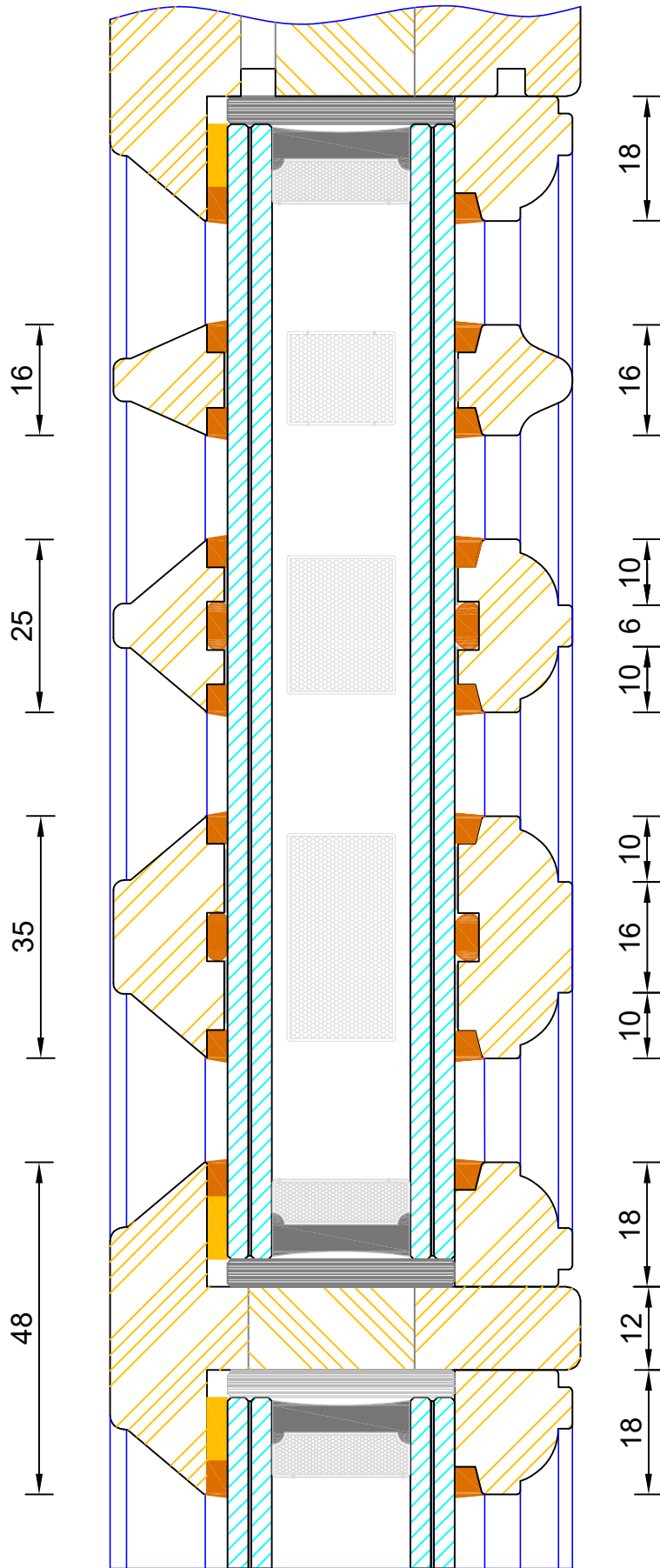

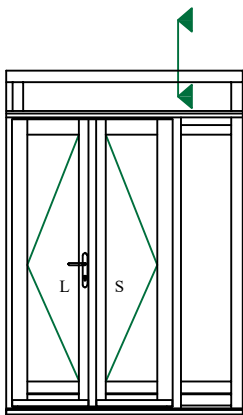

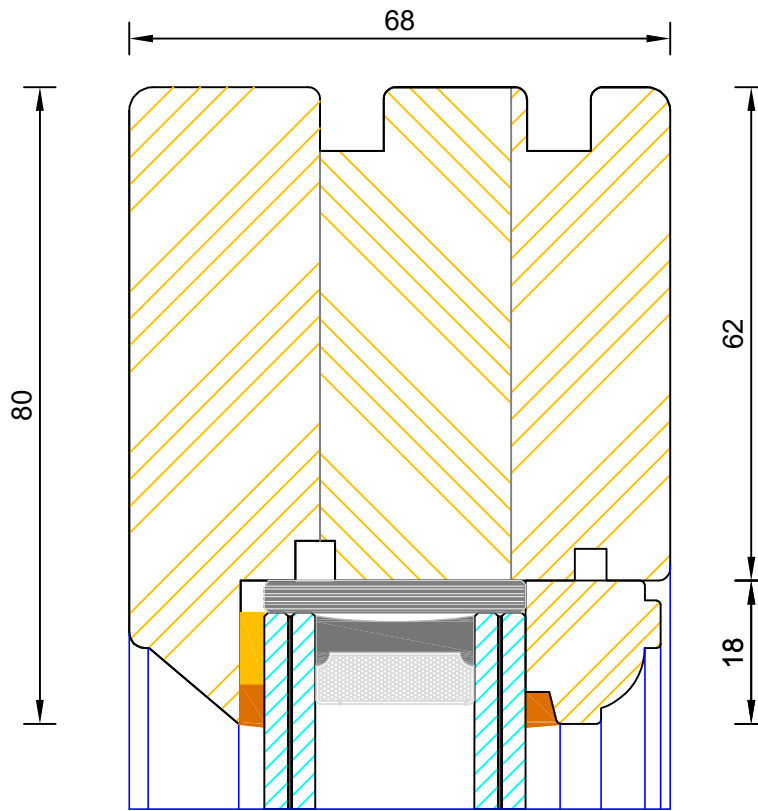
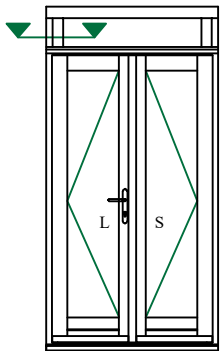
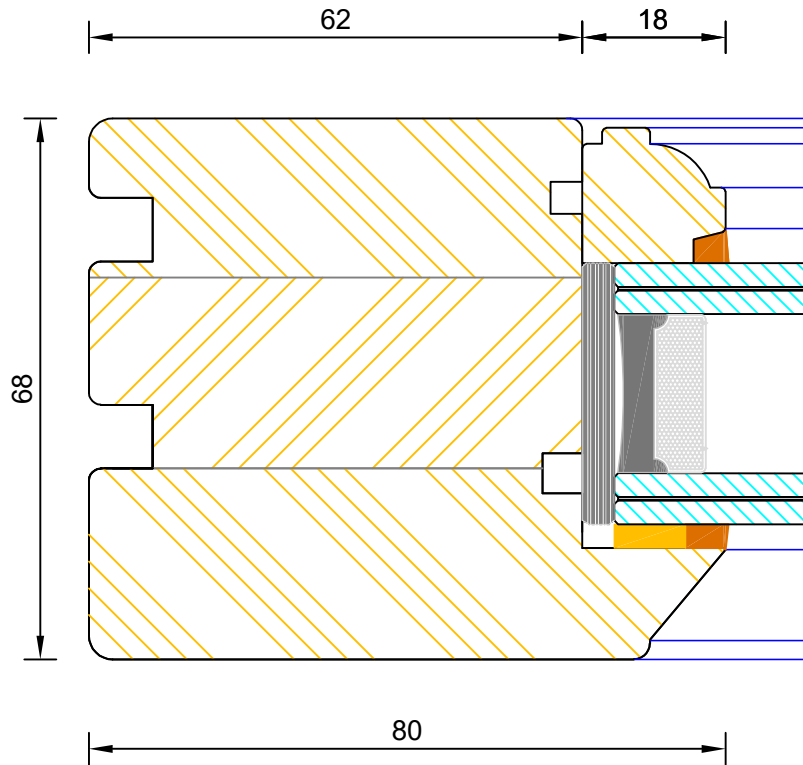

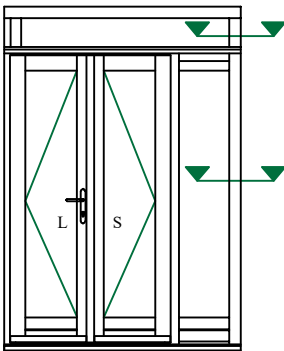
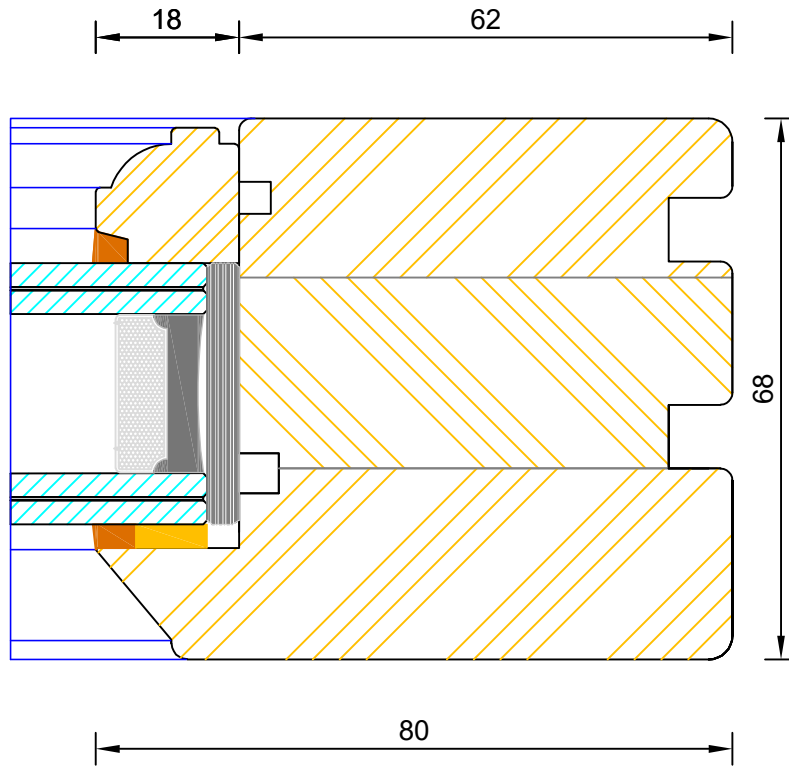

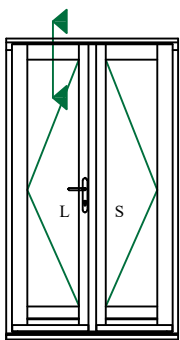
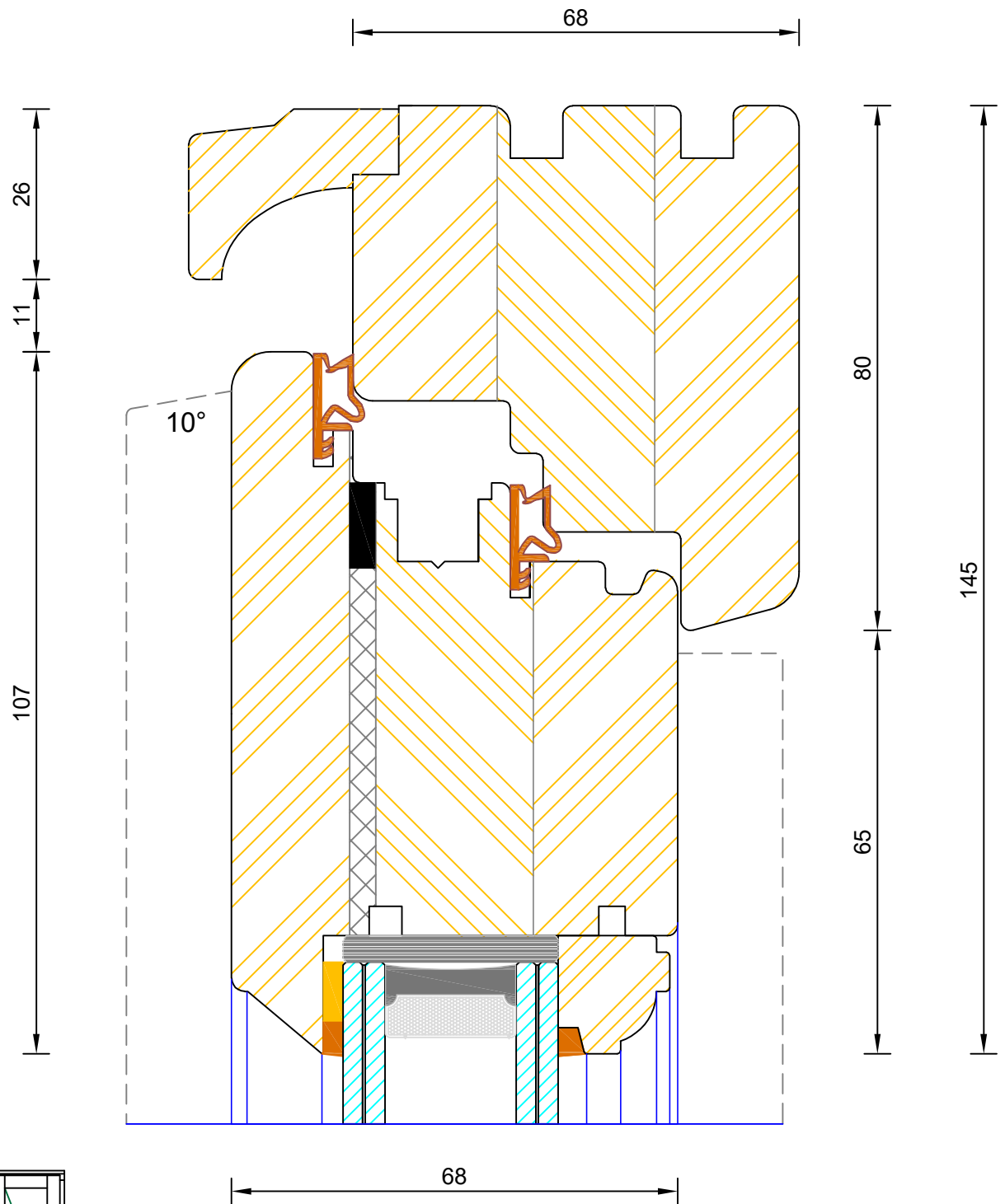

**Traditional Open Out Lipped French Door
Frame & Leaf Head (Without Vent)**

DIMENSIONS	PLOT SIZE	SCALE	DATE	REV	DWG NO.
MM	A4	1:1	03.08.2022	A	2209
Please consider the environment before printing					

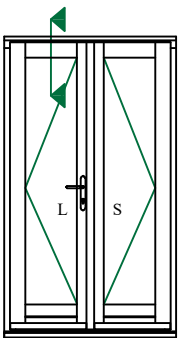
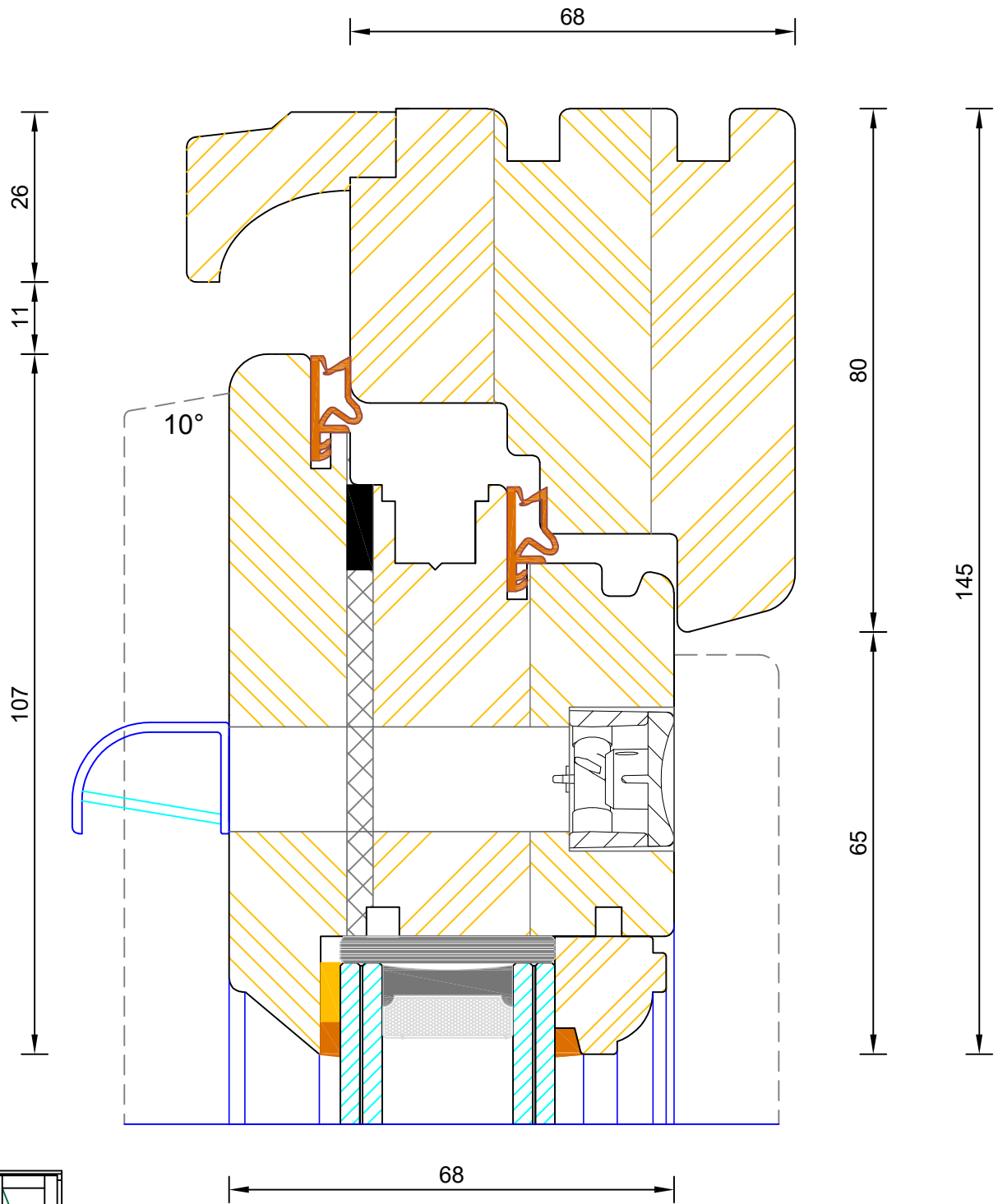

**Traditional Open Out Lipped French Door
Frame & Leaf (With Vent In Top Rail)**

DIMENSIONS	PLOT SIZE	SCALE	DATE	REV	DWG NO.
MM	A4	1:1	05.07.2022	B	2210
Please consider the environment before printing					

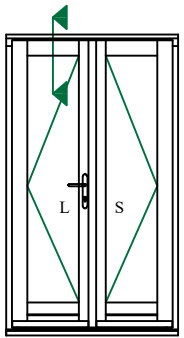
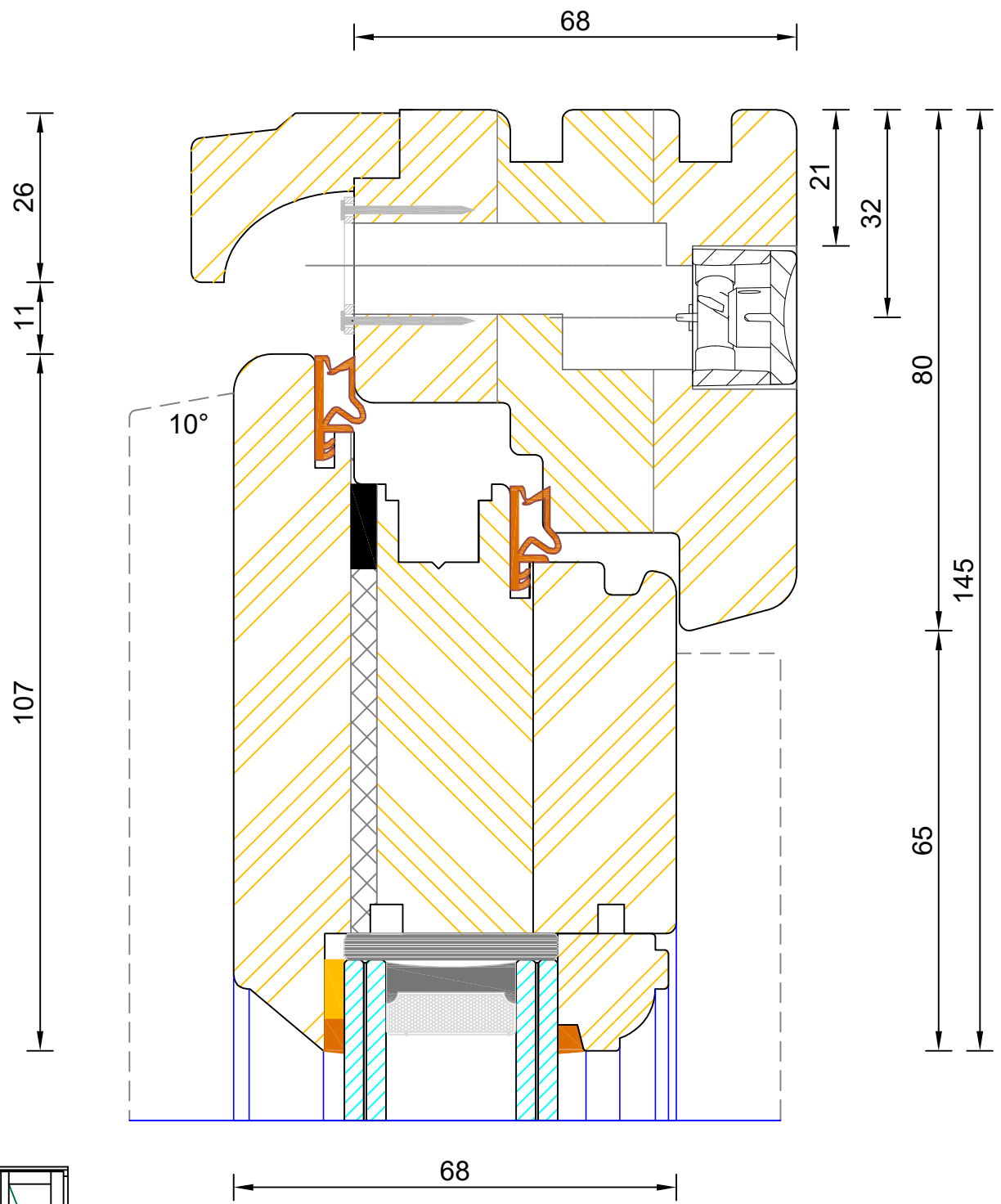

**Traditional Open Out Lipped French Door
Frame & Leaf (With Vent in Frame Head)**

DIMENSIONS	PLOT SIZE	SCALE	DATE	REV	DWG NO.
MM	A4	1:1	05.07.2022	B	2210.1
 Please consider the environment before printing					

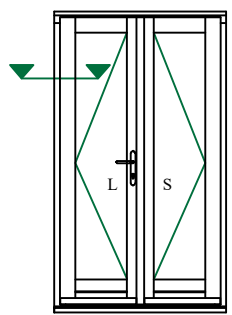
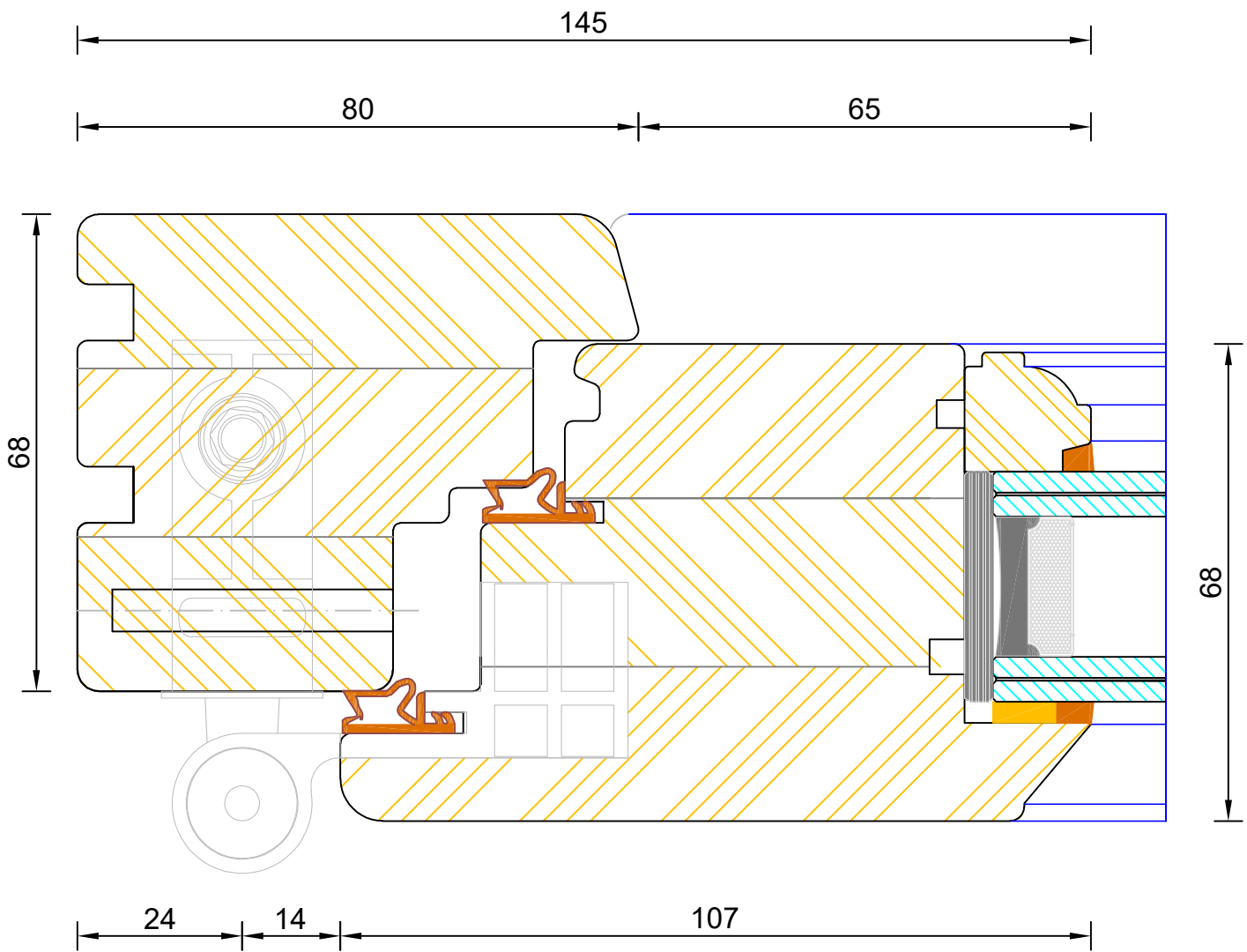

**Traditional Open Out Lipped French Door
Frame & Leaf Jamb (80mm)**

DIMENSIONS	PLOT SIZE	SCALE	DATE	REV	DWG NO.
MM	A4	1:1	03.08.2022	A	2211
Please consider the environment before printing					

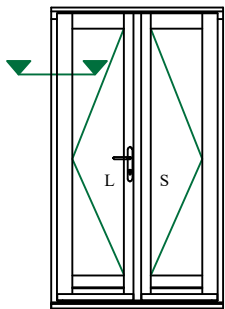
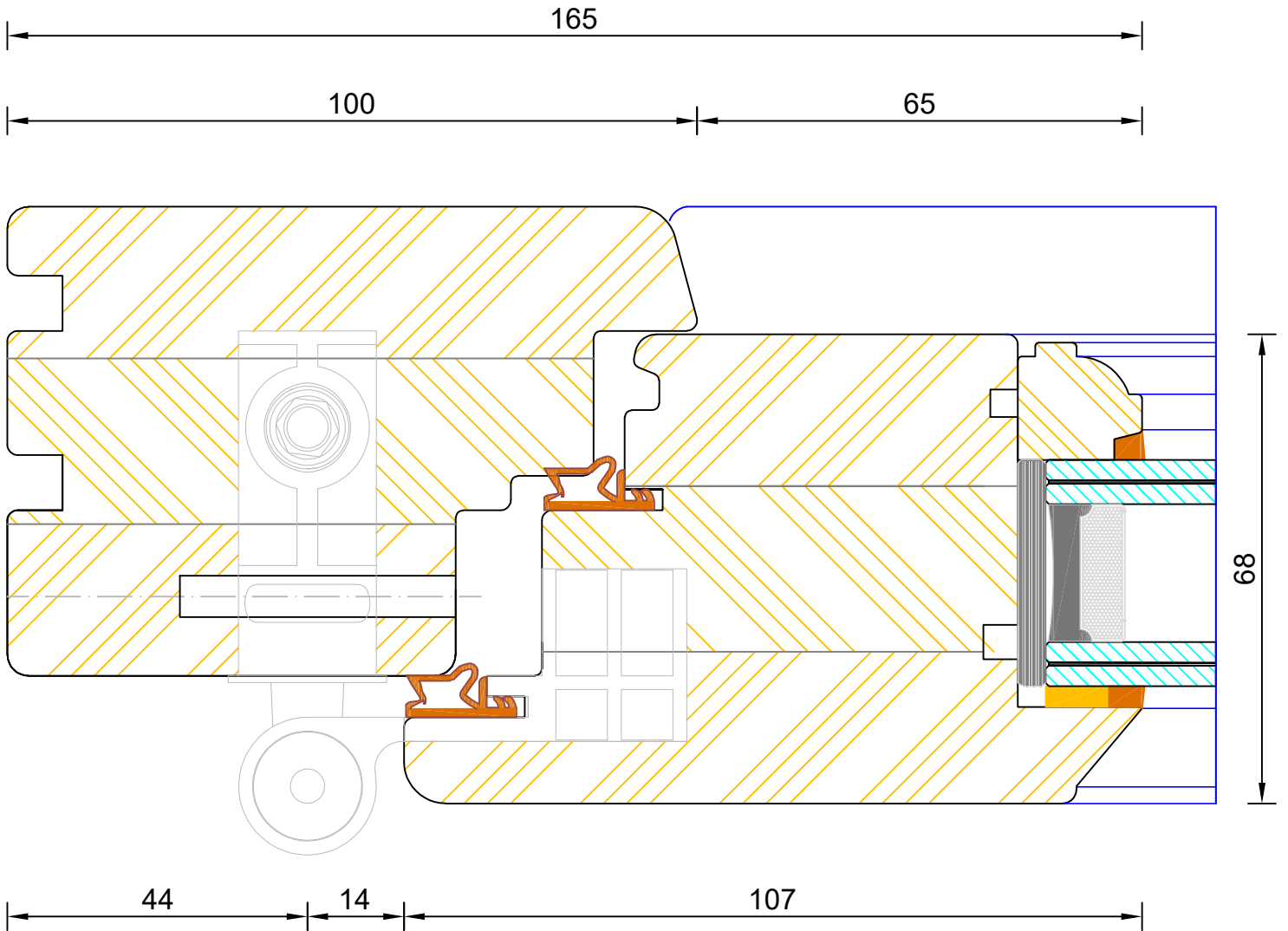

**Traditional Open Out Lipped French Door
Frame & Leaf Jamb (100mm)**

DIMENSIONS	PLOT SIZE	SCALE	DATE	REV	DWG NO.
MM	A4	1:1	03.08.2022	A	2211.1

 Please consider the environment before printing

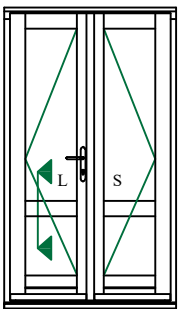
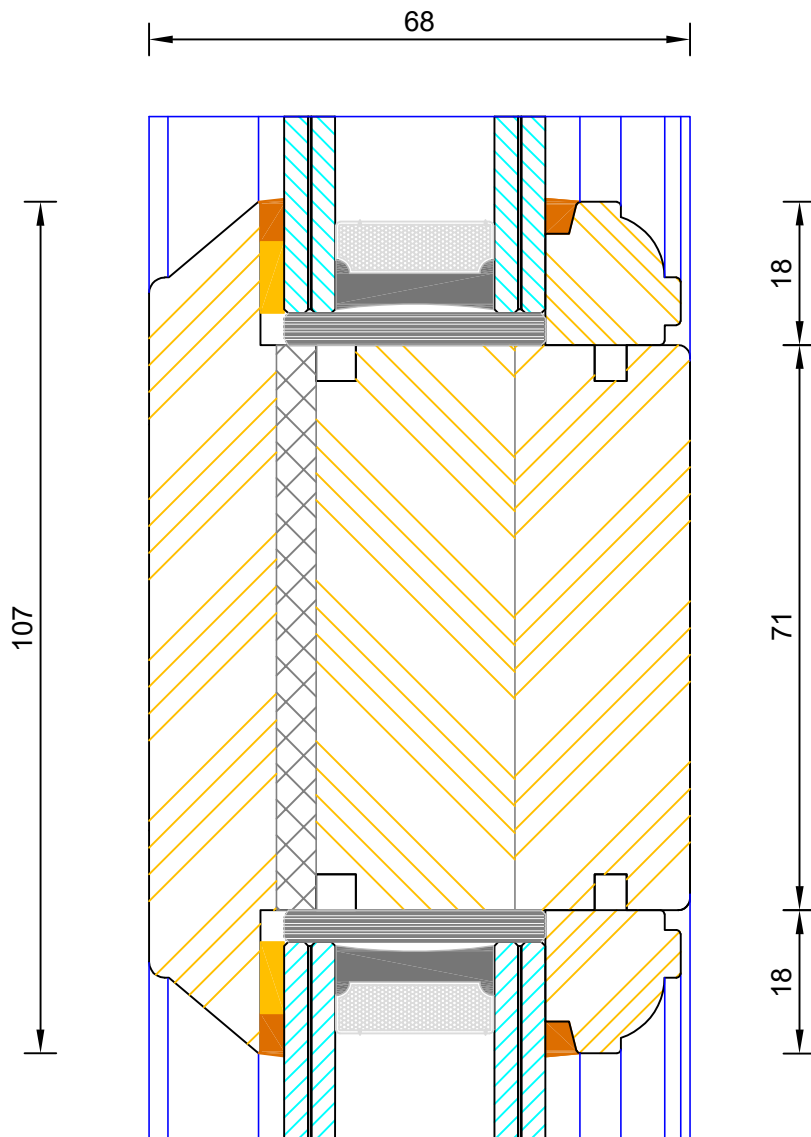

DIMENSIONS	PLOT SIZE	SCALE	DATE	REV	DWG NO.
MM	A4	1:1	03.08.2022	A	2215

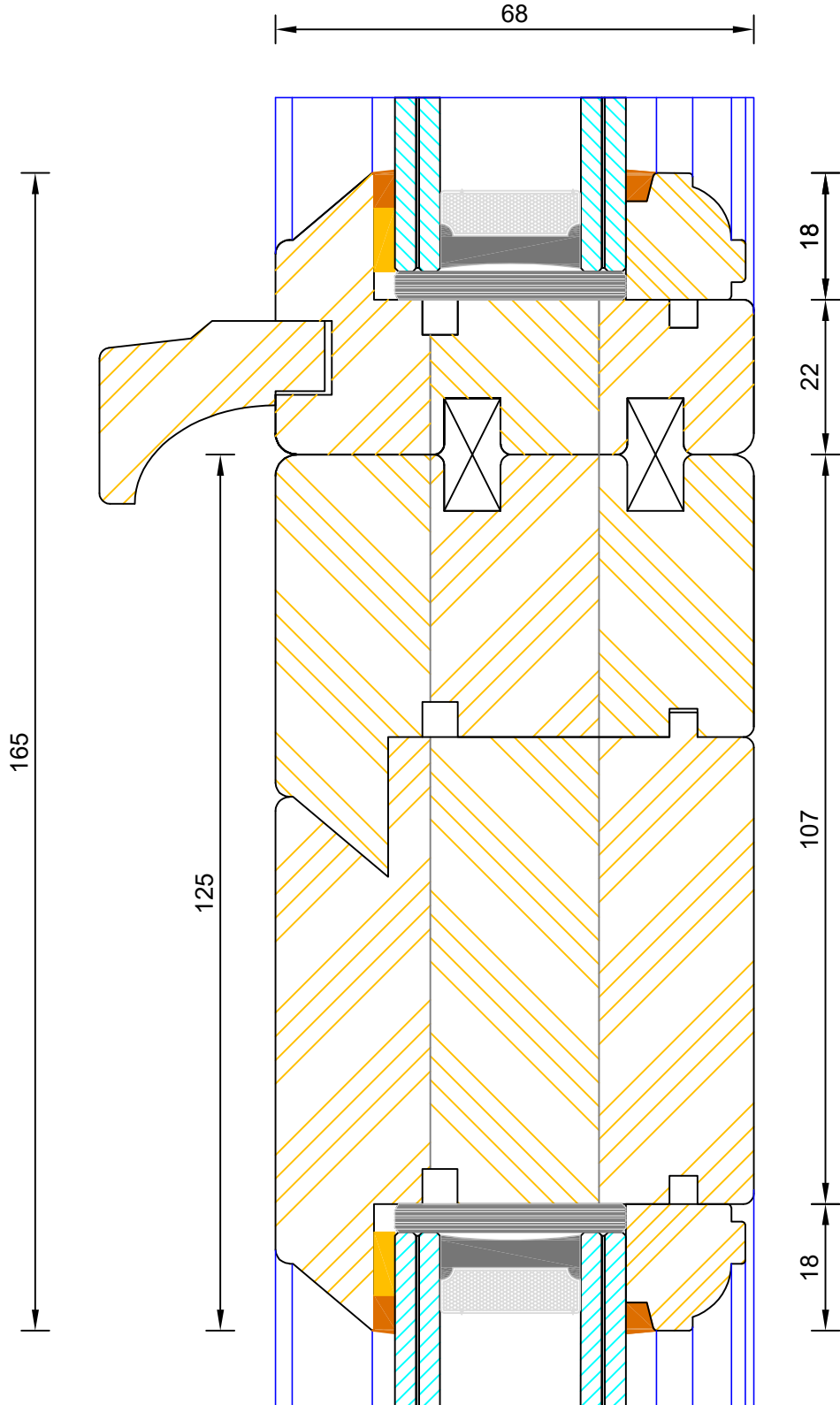
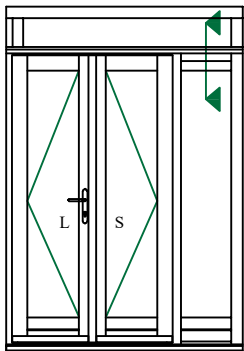

**Traditional Open Out Lipped French Door
Fanlight / Sidelight Transom**

DIMENSIONS	PLOT SIZE	SCALE	DATE	REV	DWG NO.
MM	A4	1:1	03.08.2022	A	2216
Please consider the environment before printing					

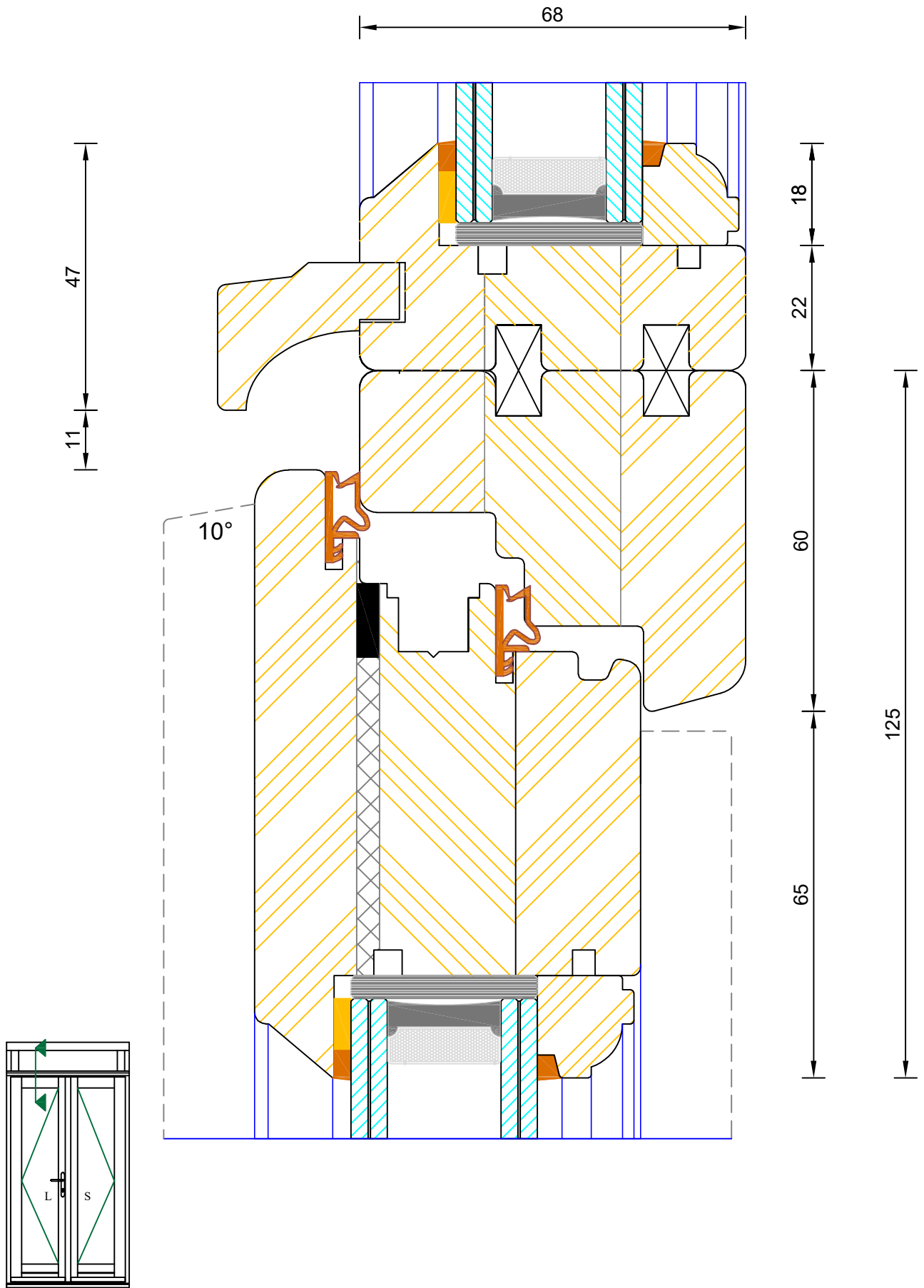

**Traditional Open Out Lipped French Door
Fanlight Transom (Leaf Without Vent)**

DIMENSIONS	PLOT SIZE	SCALE	DATE	REV	DWG NO.
MM	A4	1:1	03.08.2022	A	2217

Please consider the environment before printing



Berenco

Traditional Open Out Lipped French Door Flying Mullion (Double Handle)

DIMENSIONS	PLOT SIZE	SCALE	DATE	REV	DWG. NO.
MM	A1	1:1	03.08.2022	A	2219.1

Please consider the environment before printing

2219.1

Note: Used as standard on doors >2301mm high

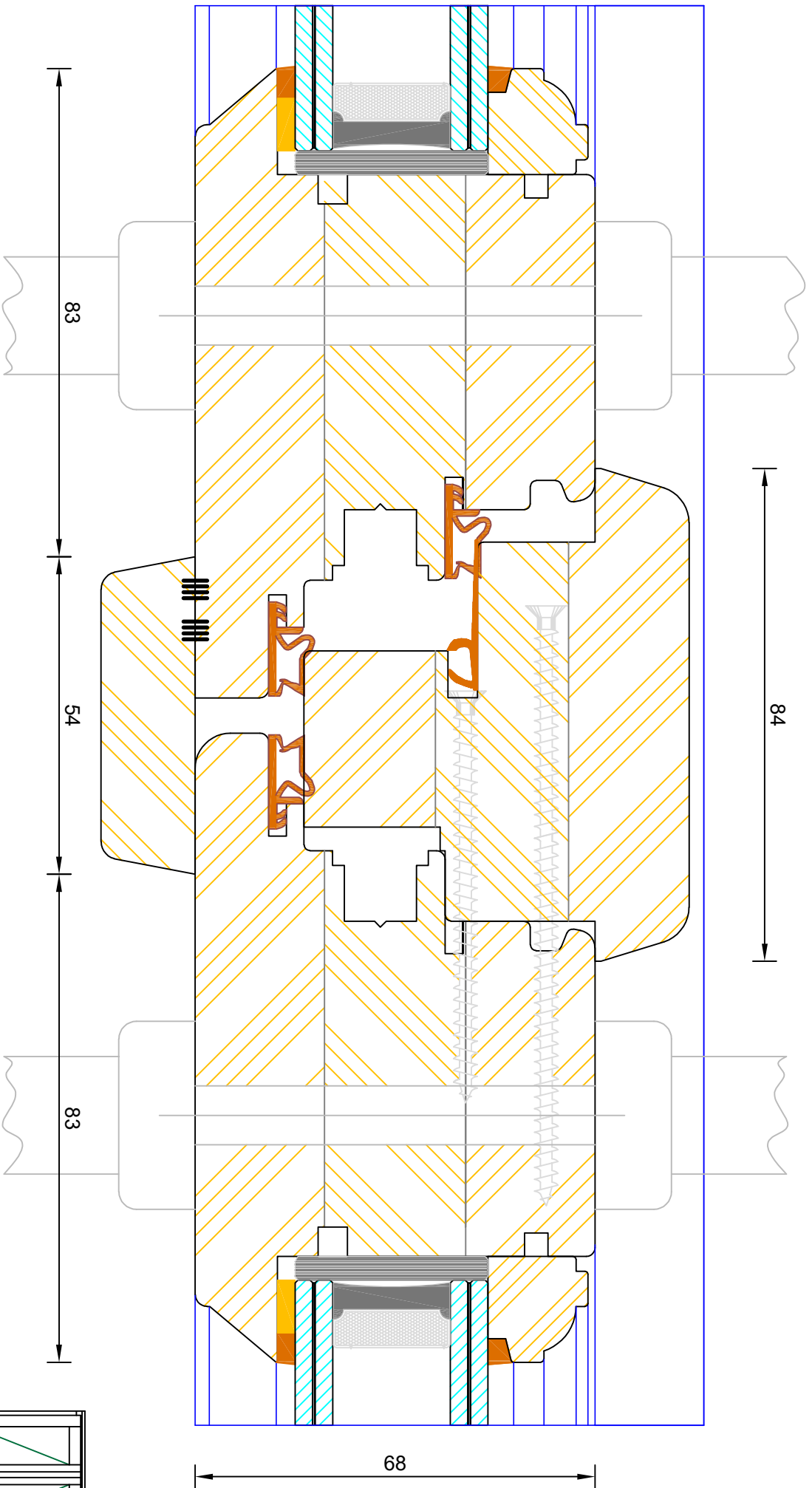
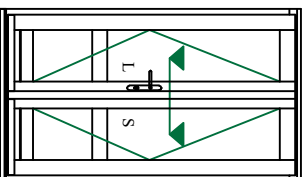

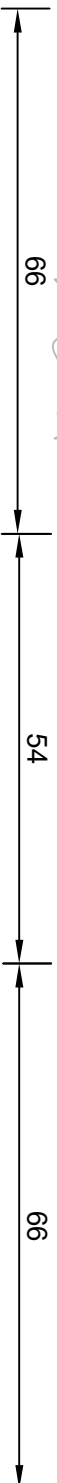
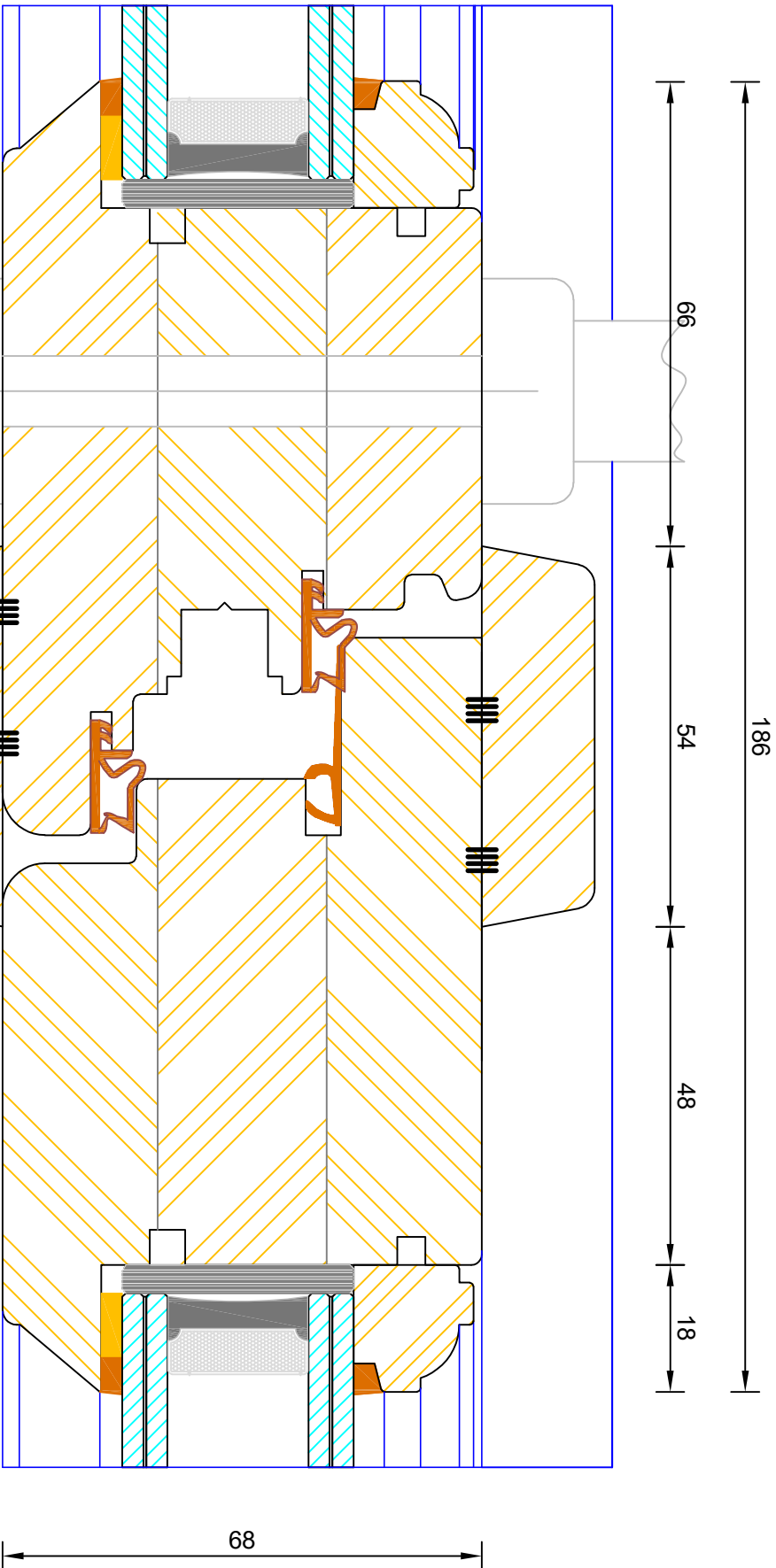

Traditional Open Out Lipped French Door
Flying Mullion (Single Handle)

DIMENSIONS	PLOT SIZE	SCALE	DATE	REV	DWG. NO.
MM	A1	1:1	03.08.2022	A	2219.2

Please consider the environment before printing



Berenco

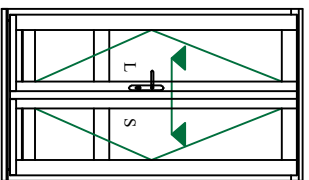

Note: Used as standard on doors <2300mm high unless otherwise specified



Berenco

Traditional Open Out Lipped French Door Solid Mullion

DIMENSIONS	PLOT SIZE	SCALE	DATE	REV	DWG. NO.
MM	A1	1:1	03.08.2022	A	22220

Please consider the environment before printing

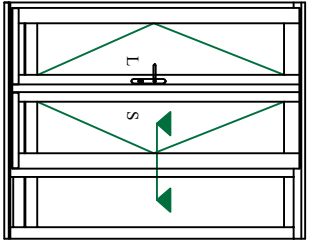
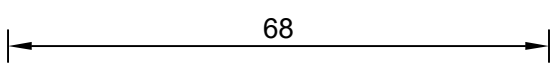
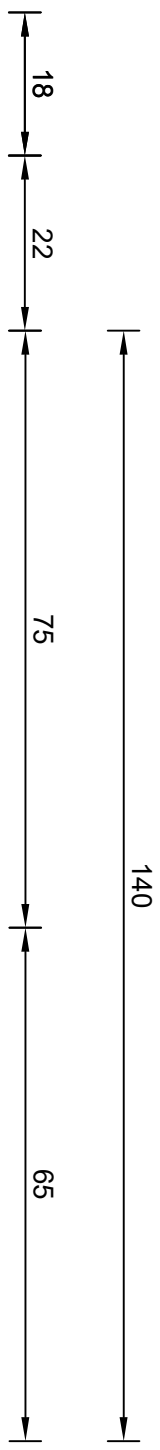
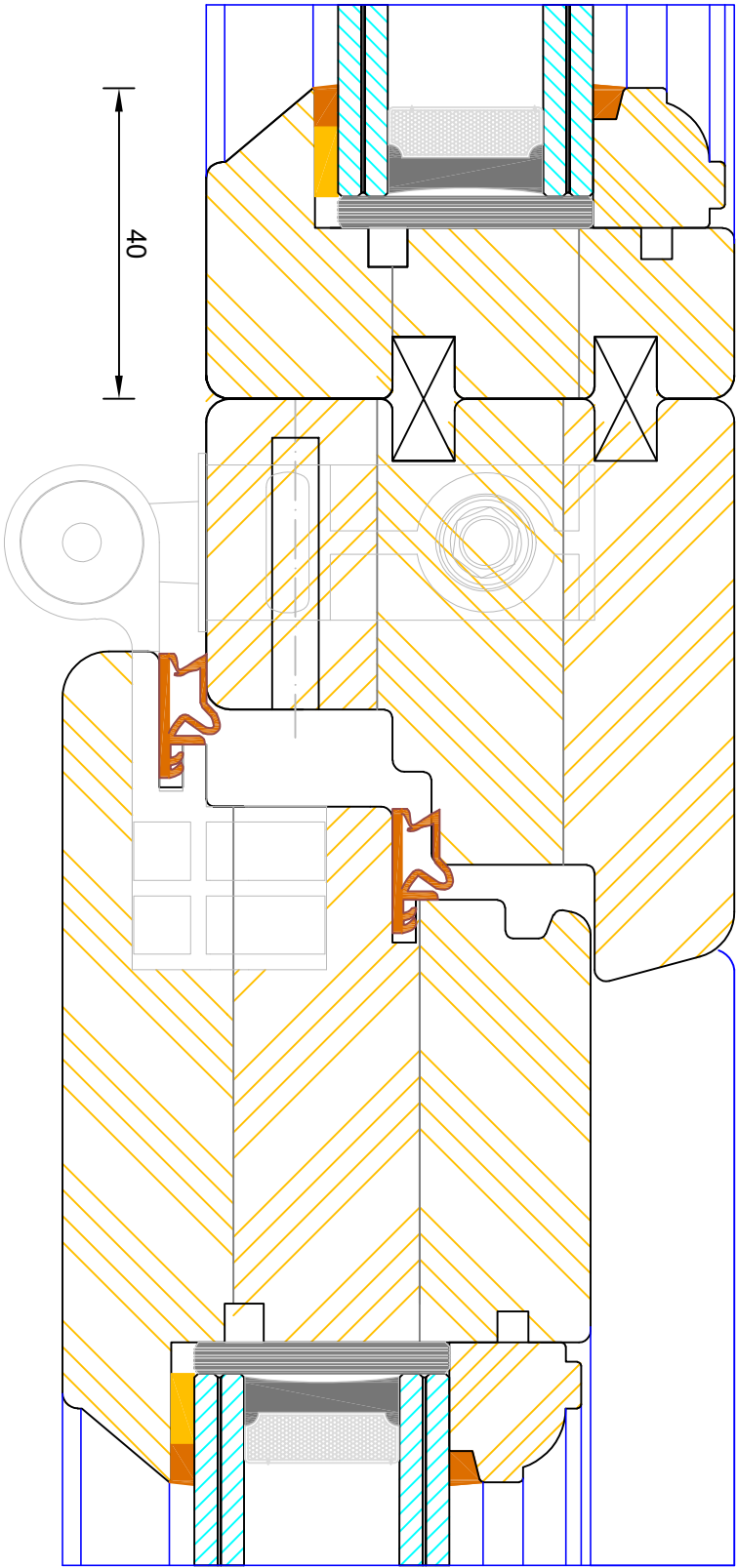

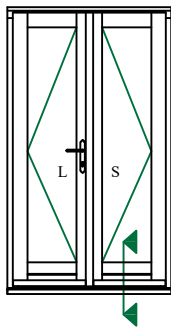
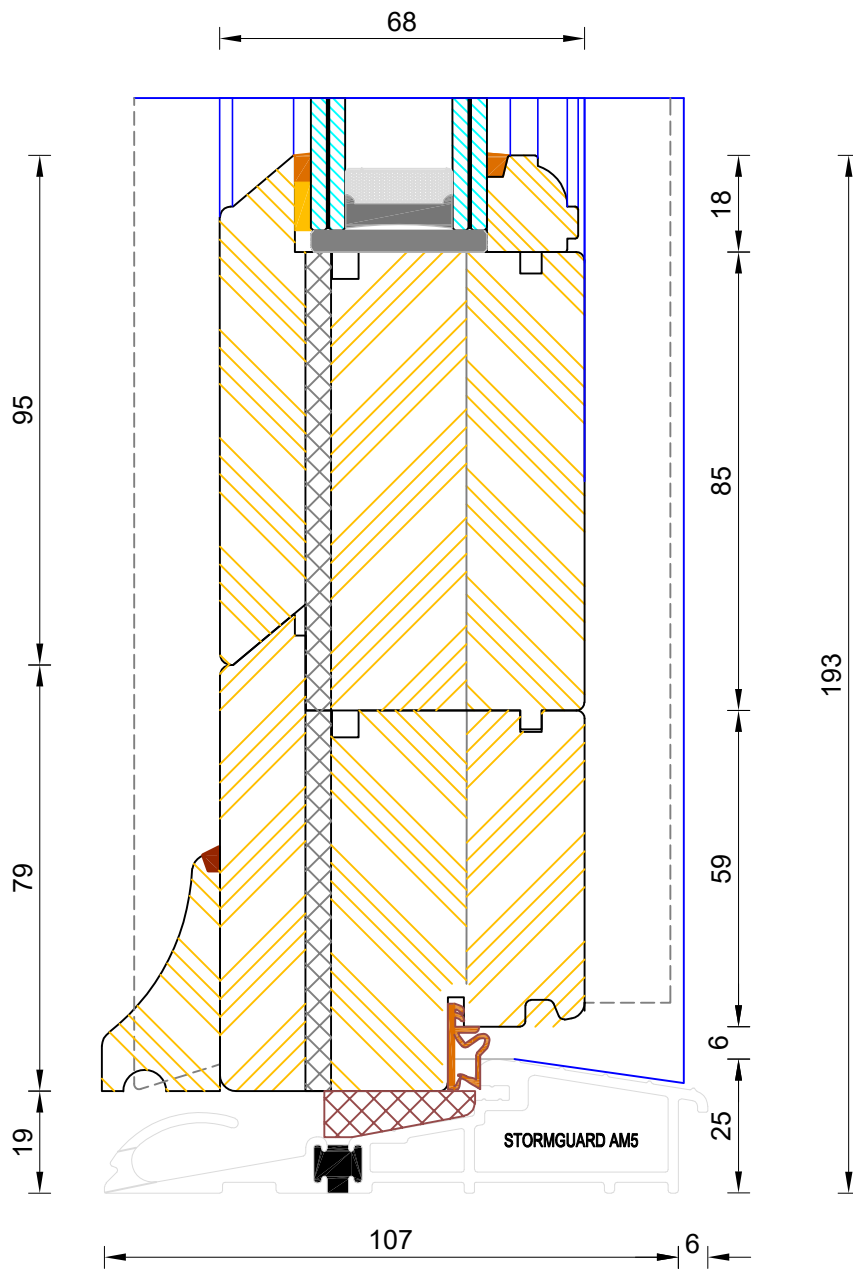

**Traditional Open Out Lipped French Door
Mobility Thresh**

DIMENSIONS	PLOT SIZE	SCALE	DATE	REV	DWG NO.
MM	A3	1:1	03.08.2022	A	2214

Please consider the environment before printing

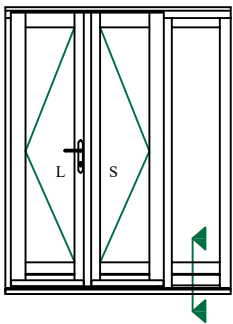
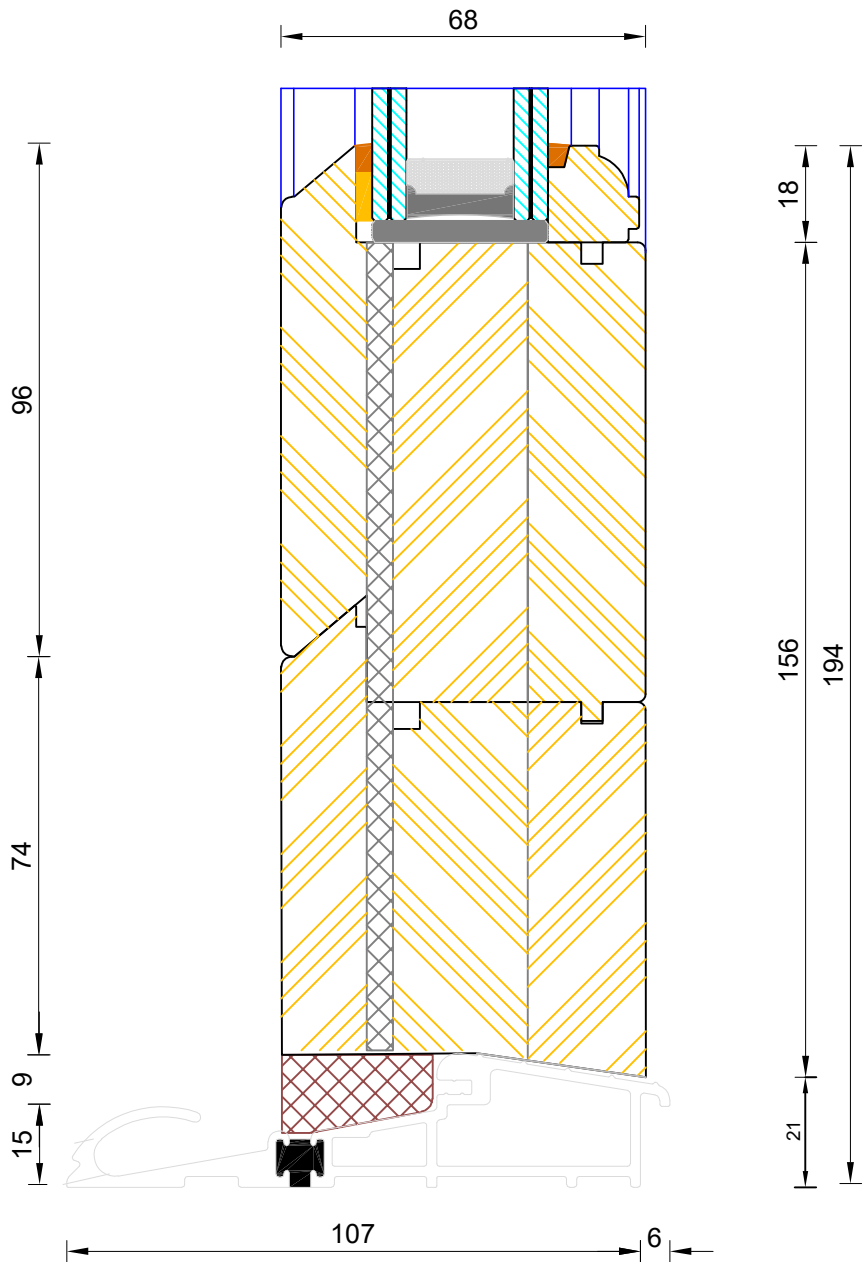

**Traditional Open Out Lipped French Door
Mobility Threshold (Sidelight)**

DIMENSIONS	PLOT SIZE	SCALE	DATE	REV	DWG NO.
MM	A3	1:1	03.08.2022	A	2208
Please consider the environment before printing					

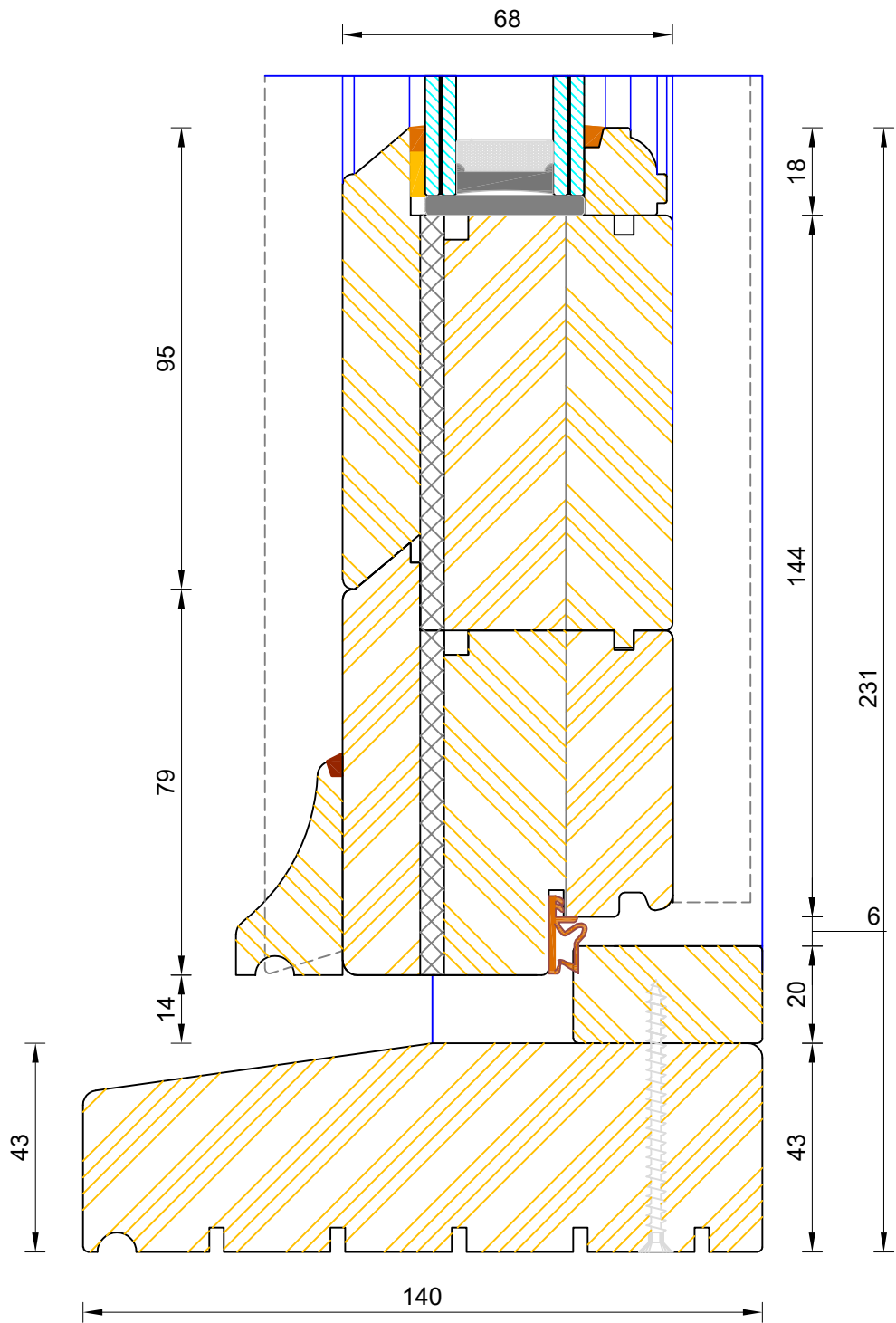
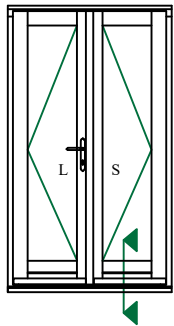

If not otherwise stated, Hardwood Threshold will be stained 5064 Walnut



Traditional Open Out Lipped French Door Standard Thresh

DIMENSIONS	PLOT SIZE	SCALE	DATE	REV	DWG NO.
MM	A3	1:1	03.08.2022	A	2212
Please consider the environment before printing					

Please consider the environment before printing

2212

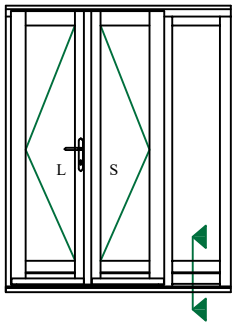
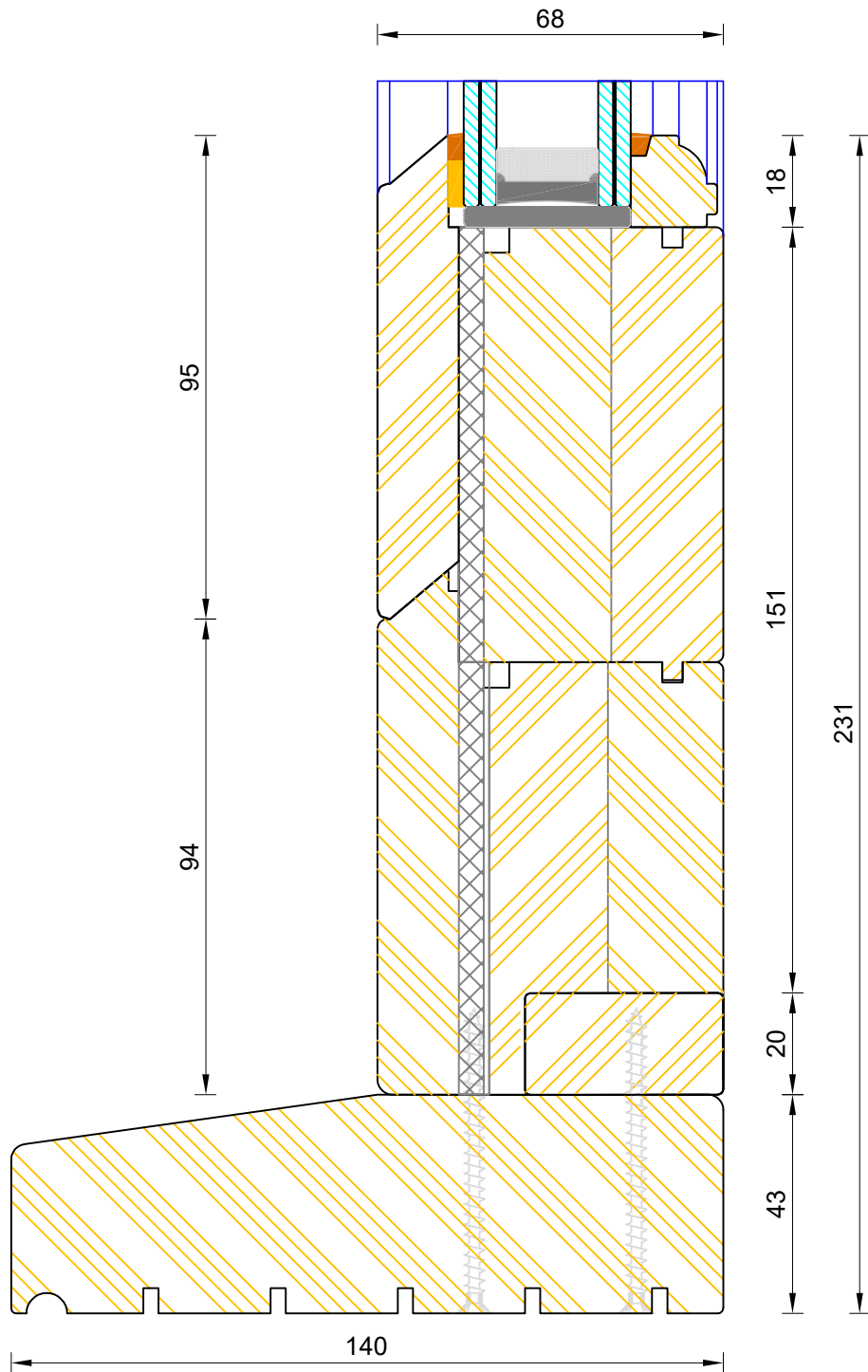

If not otherwise stated, Hardwood Threshold will be stained 5064 Walnut



**Traditional Open Out Lipped French Door
Standard Thresh (Sidelight)**

DIMENSIONS	PLOT SIZE	SCALE	DATE	REV	DWG NO.
MM	A3	1:1	03.08.2022	A	2206
Please consider the environment before printing					

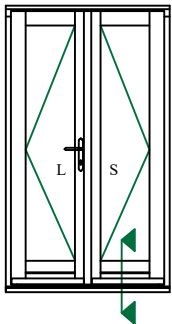
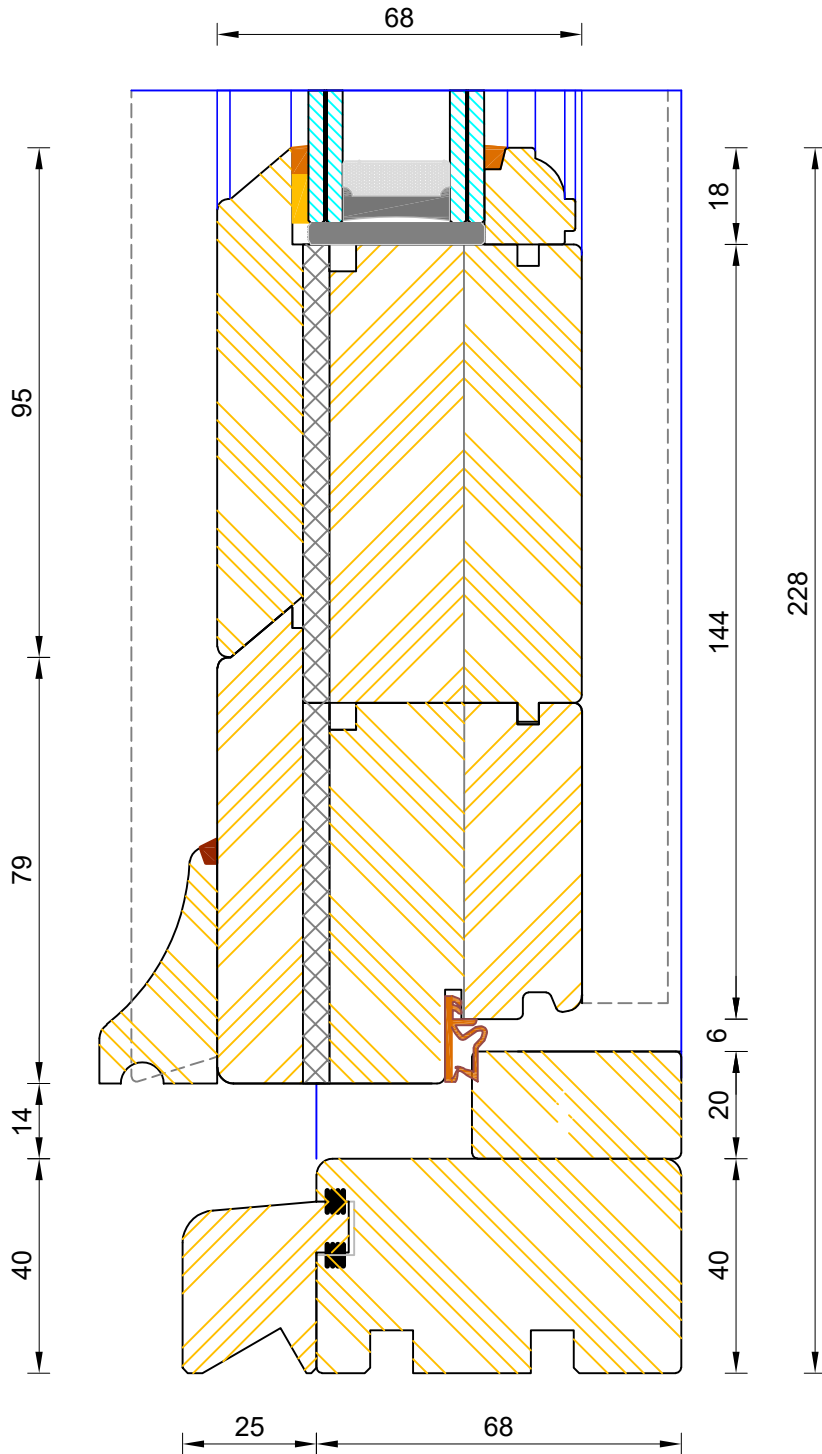

CILL EXTENSION - available options: 25mm (93mm o/a) / 47mm (115mm o/a) / 62mm (129mm o/a) / 87mm (155mm o/a) / 114mm (182mm o/a) / 125mm (193mm o/a) / 140mm (208mm o/a)

NOTE: Cill Extensions should be supported from underneath; the maximum overhang over Brick / Blockwork for cill extension should not exceed 25mm In order to avoid damage when stepped on. Warranties are Invalidated when fitted with overhang Out excess to that.

If not otherwise stated, Hardwood Threshold will be stained 5064 Walnut



**Traditional Open Out Lipped French Door
Coupling Thresh**

DIMENSIONS	PLOT SIZE	SCALE	DATE	REV	DWG NO.
MM	A3	1:1	03.08.2022	A	2213
Please consider the environment before printing					

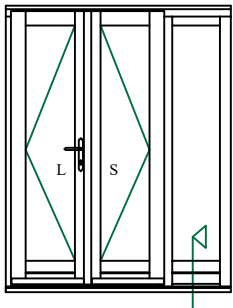
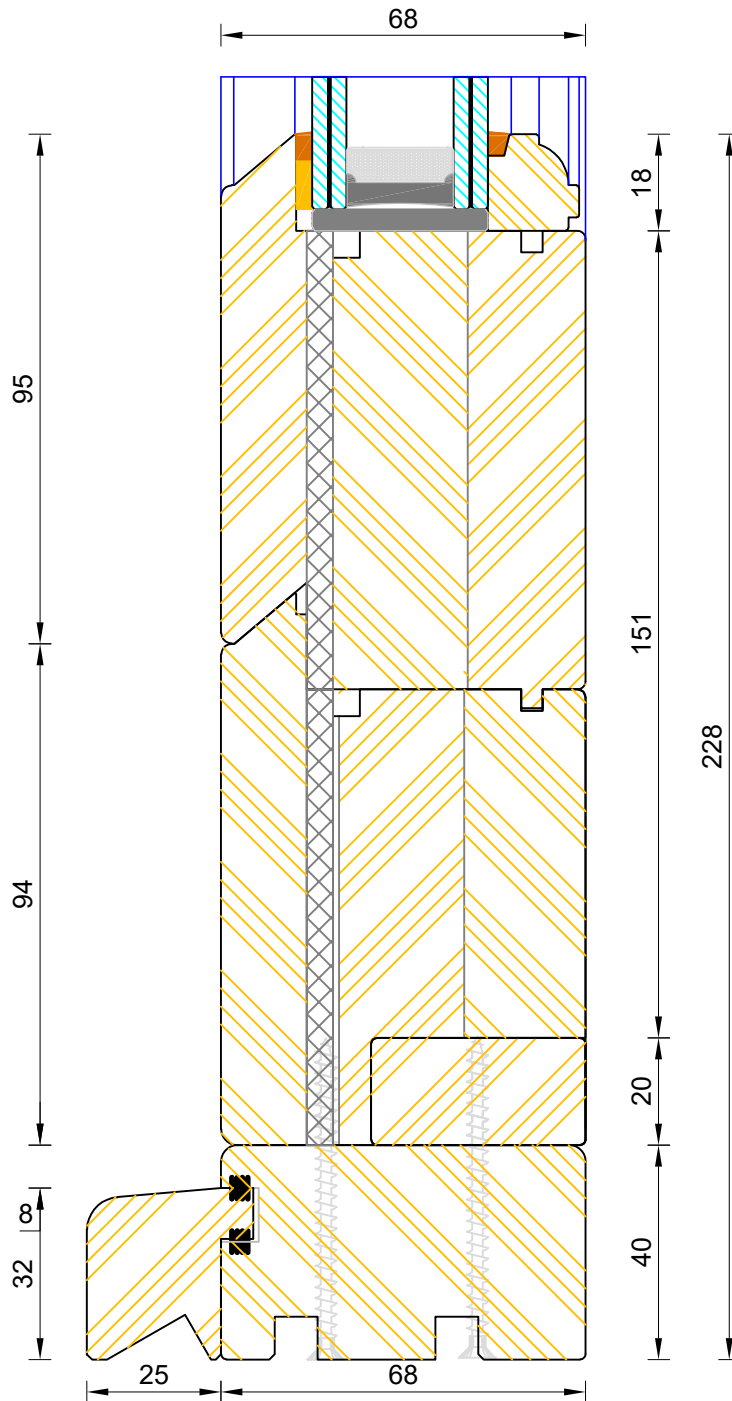

CILL EXTENSION - available options: 25mm (93mm o/a) / 47mm (115mm o/a) / 62mm (129mm o/a) / 87mm (155mm o/a) / 114mm (182mm o/a) / 125mm (193mm o/a) / 140mm (208mm o/a)

NOTE: Cill Extensions should be supported from underneath; the maximum overhang over Brick / Blockwork for cill extension should not exceed 25mm In order to avoid damage when stepped on. Warranties are Invalidated when fitted with overhang Out excess to that.

If not otherwise stated, Hardwood Threshold will be stained 5064 Walnut



Traditional Open Out Lipped French Door Coupling Thresh (Sidelight)

DIMENSIONS	PLOT SIZE	SCALE	DATE	REV	DWG NO.
MM	A3	1:1	03.08.2022	A	2207
 Please consider the environment before printing					