

**Traditional Open In Flush Entrance Door**  
Triple Glazed - Cill Extension Options

DIMENSIONS	PLOT SIZE	SCALE	DATE	REV	DWG NO.
MM	A4	1:1	25.09.2019	B	<b>2351</b>
Please consider the environment before printing					

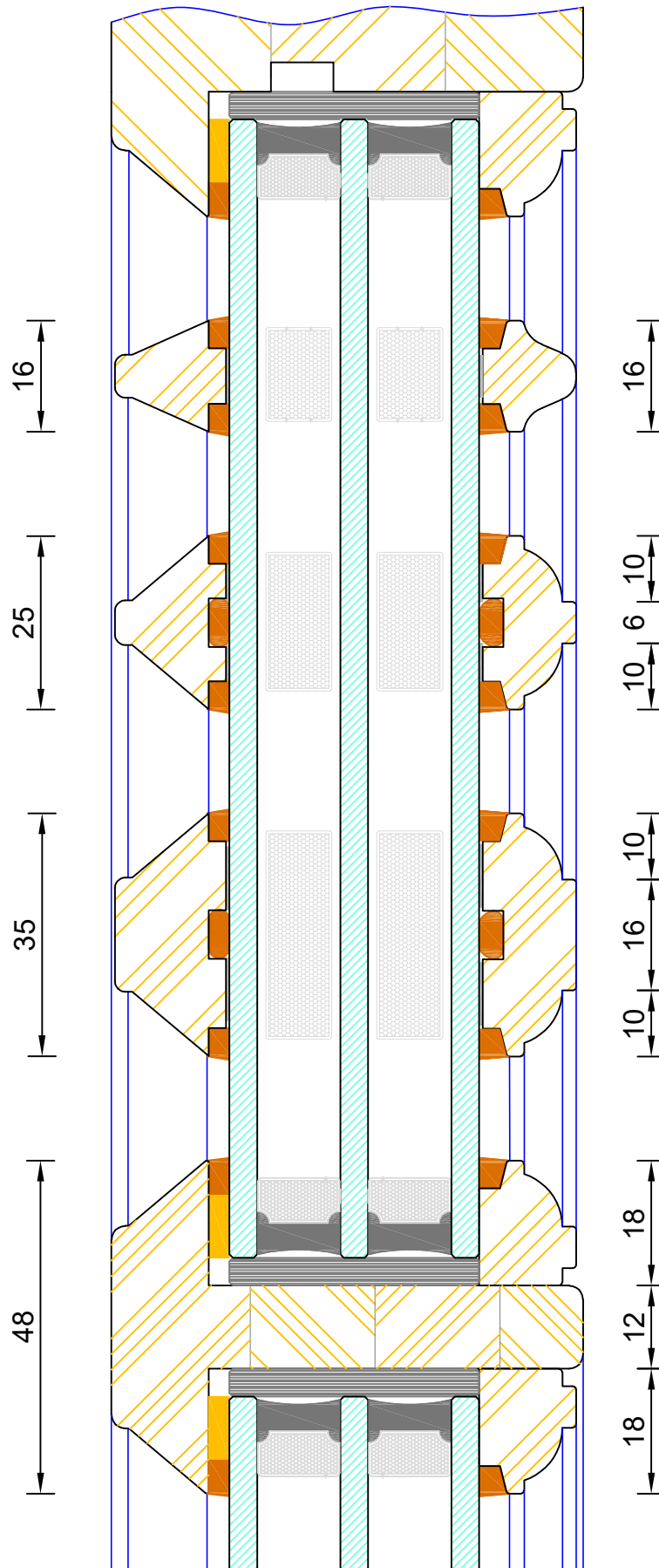

**Bereco**

**Traditional Open In Flush Entrance Door  
Triple Glazed - Bar Options**

DIMENSIONS	PLOT SIZE	SCALE	DATE	REV	DWG NO.
MM	A4	1:1	01.01.2019	B	<b>2352</b>
Please consider the environment before printing					

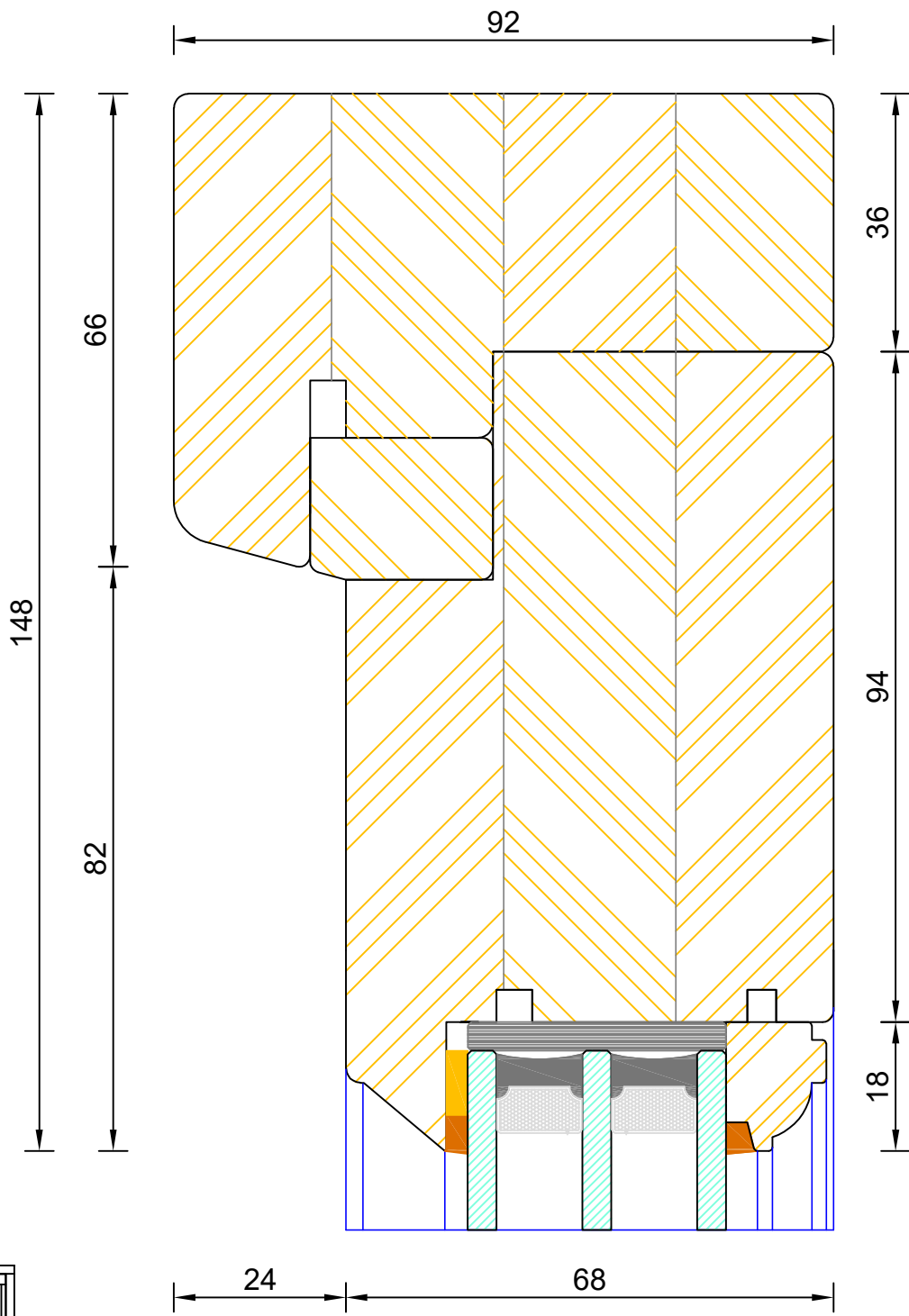
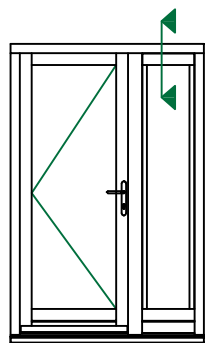

**Traditional Open In Flush Entrance Door**  
**Triple Glazed - Sidelight Head**

DIMENSIONS	PLOT SIZE	SCALE	DATE	REV	DWG NO.
MM	A4	1:1	10.08.2022	A	<b>2353</b>
Please consider the environment before printing					

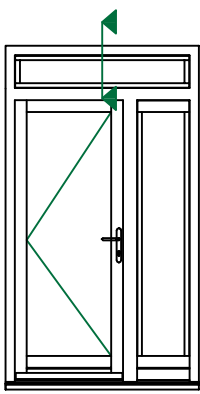
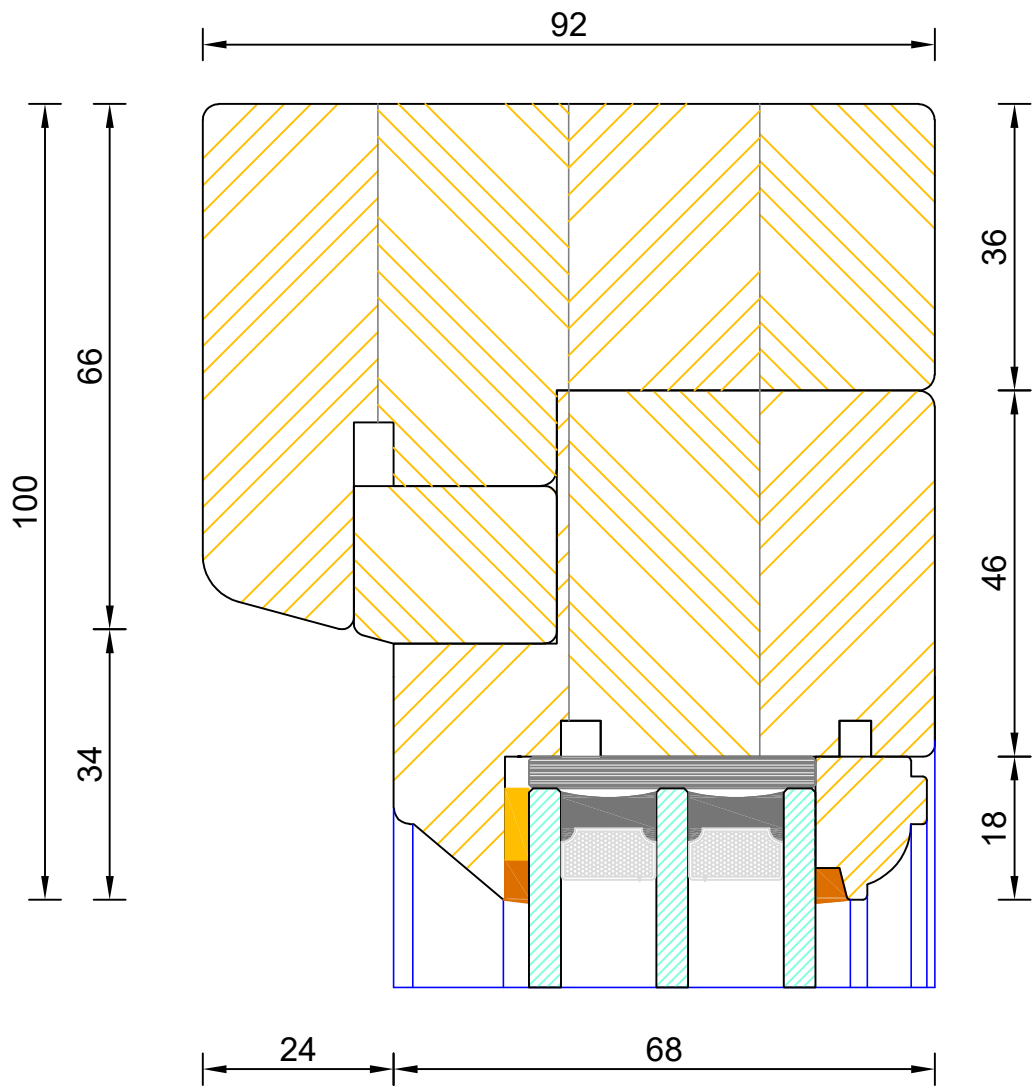

**Traditional Open In Flush Entrance Door  
Triple Glazed - Fanlight Head**

DIMENSIONS	PLOT SIZE	SCALE	DATE	REV	DWG NO.
MM	A4	1:1	10.08.2022	A	<b>2354</b>
Please consider the environment before printing					

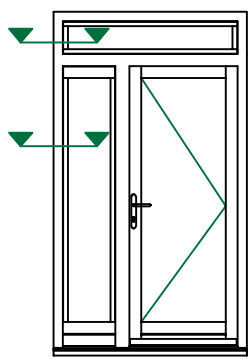
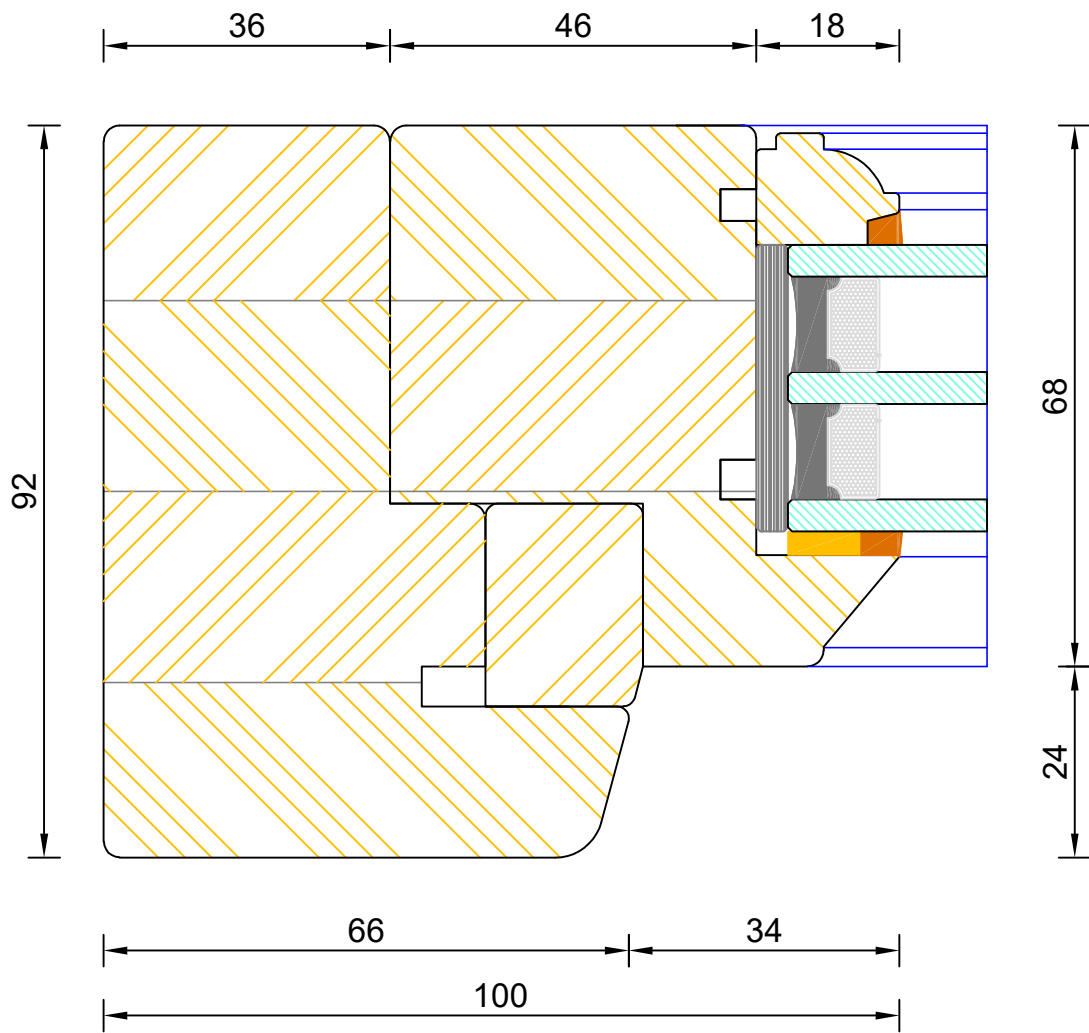

**Traditional Open In Flush Entrance Door**  
**Triple Glazed - Sidelight / Fanlight Jamb**

DIMENSIONS	PLOT SIZE	SCALE	DATE	REV	DWG NO.
MM	A4	1:1	10.08.2022	A	<b>2355</b>
Please consider the environment before printing					

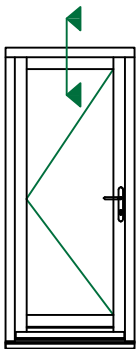
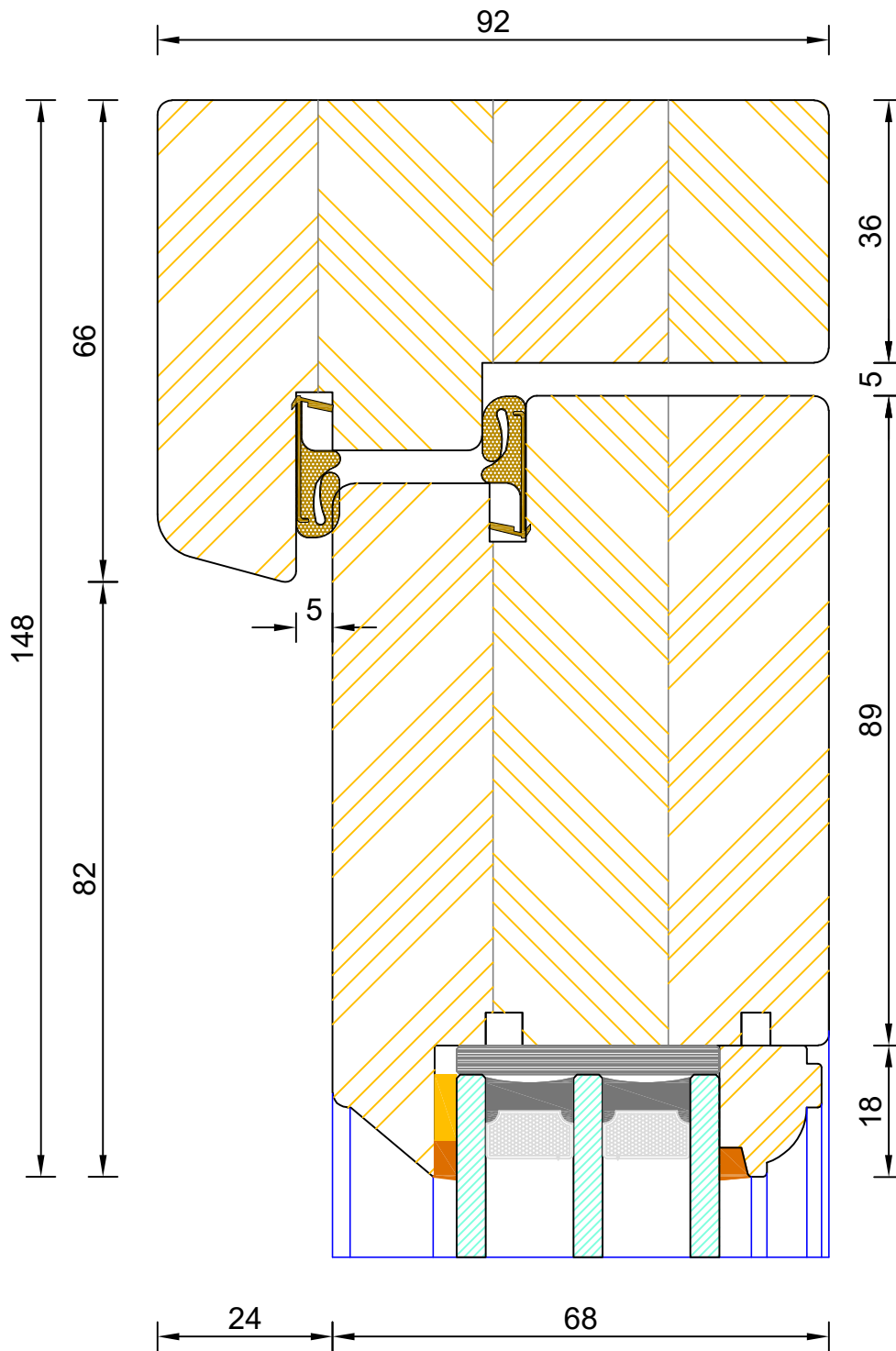

**Traditional Open In Flush Entrance Door**  
Triple Glazed - Frame & Leaf Head

DIMENSIONS	PLOT SIZE	SCALE	DATE	REV	DWG NO.
MM	A4	1:1	10.08.2022	A	<b>2359</b>
Please consider the environment before printing					

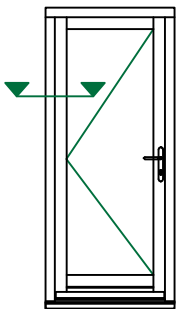
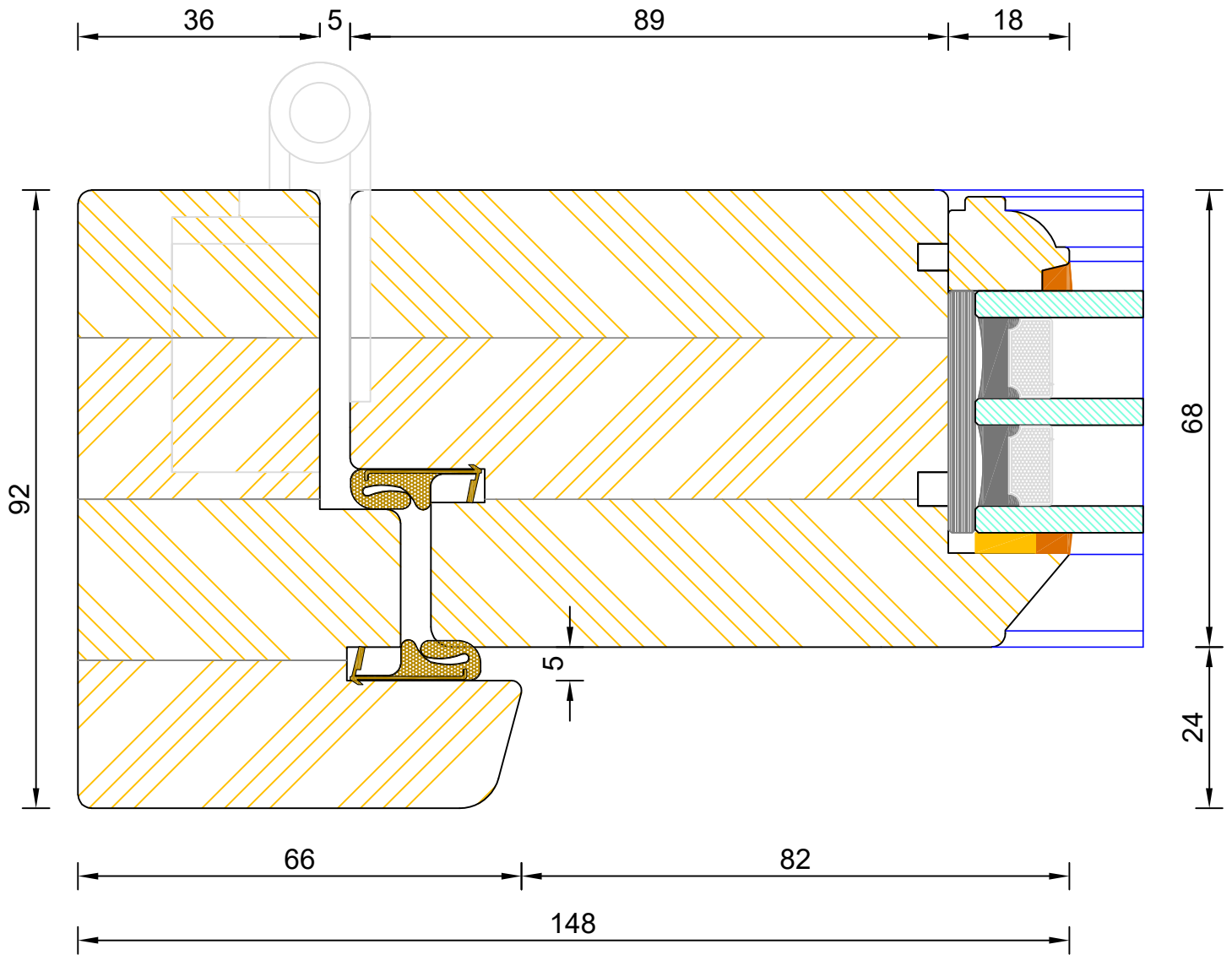

**Traditional Open In Flush Entrance Door**  
Triple Glazed - Frame & Leaf Jamb (Hinge Side)

DIMENSIONS	PLOT SIZE	SCALE	DATE	REV	DWG NO.
MM	A4	1:1	10.08.2022	A	<b>2360</b>
Please consider the environment before printing					

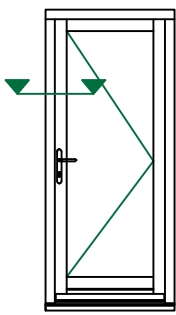
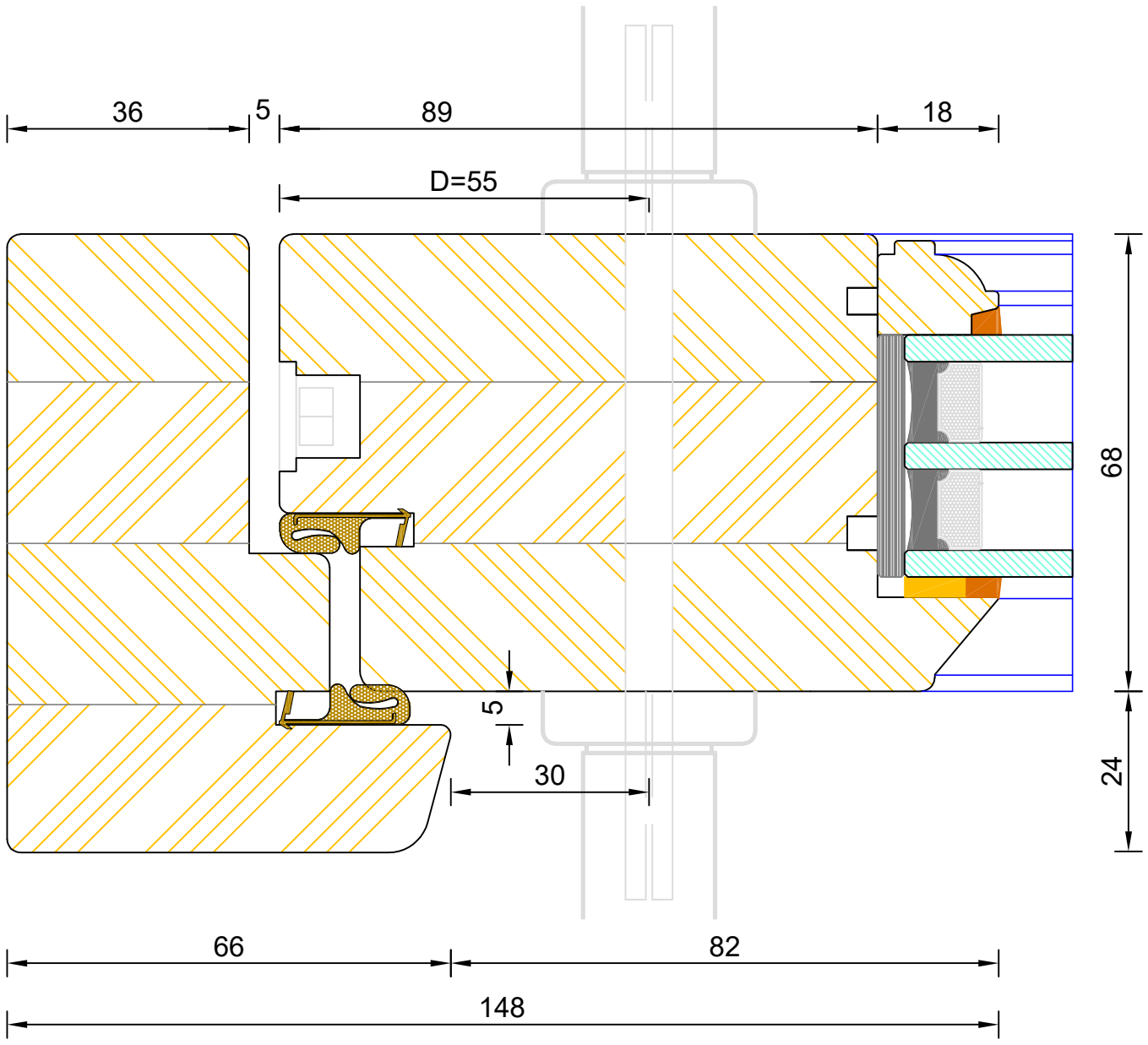

**Traditional Open In Flush Entrance Door**  
 Triple Glazed - Frame & Leaf Jamb (Handle Side)

DIMENSIONS	PLOT SIZE	SCALE	DATE	REV	DWG NO.
MM	A4	1:1	10.08.2022	A	<b>2361</b>
Please consider the environment before printing					



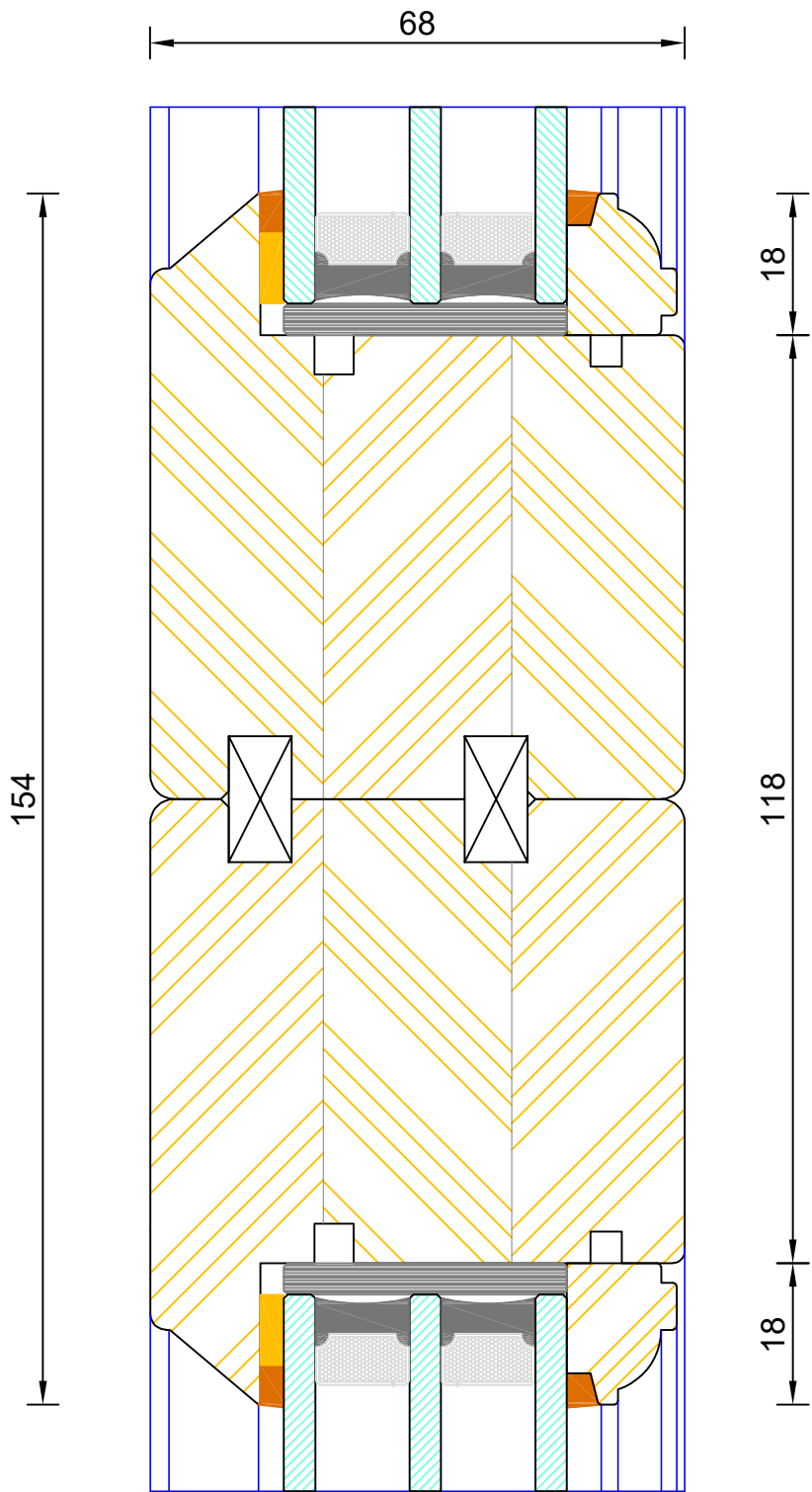
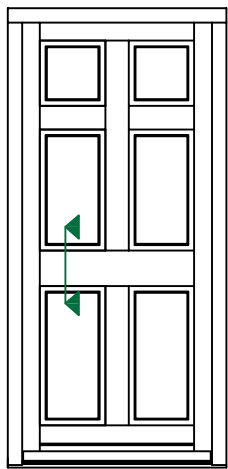

DIMENSIONS	PLOT SIZE	SCALE	DATE	REV	DWG NO.
MM	A4	1:1	10.08.2022	A	<b>2365</b>

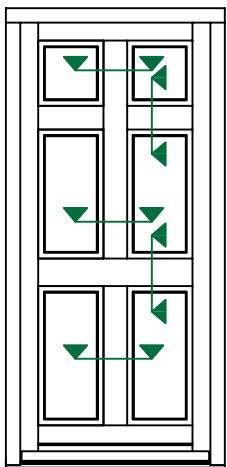
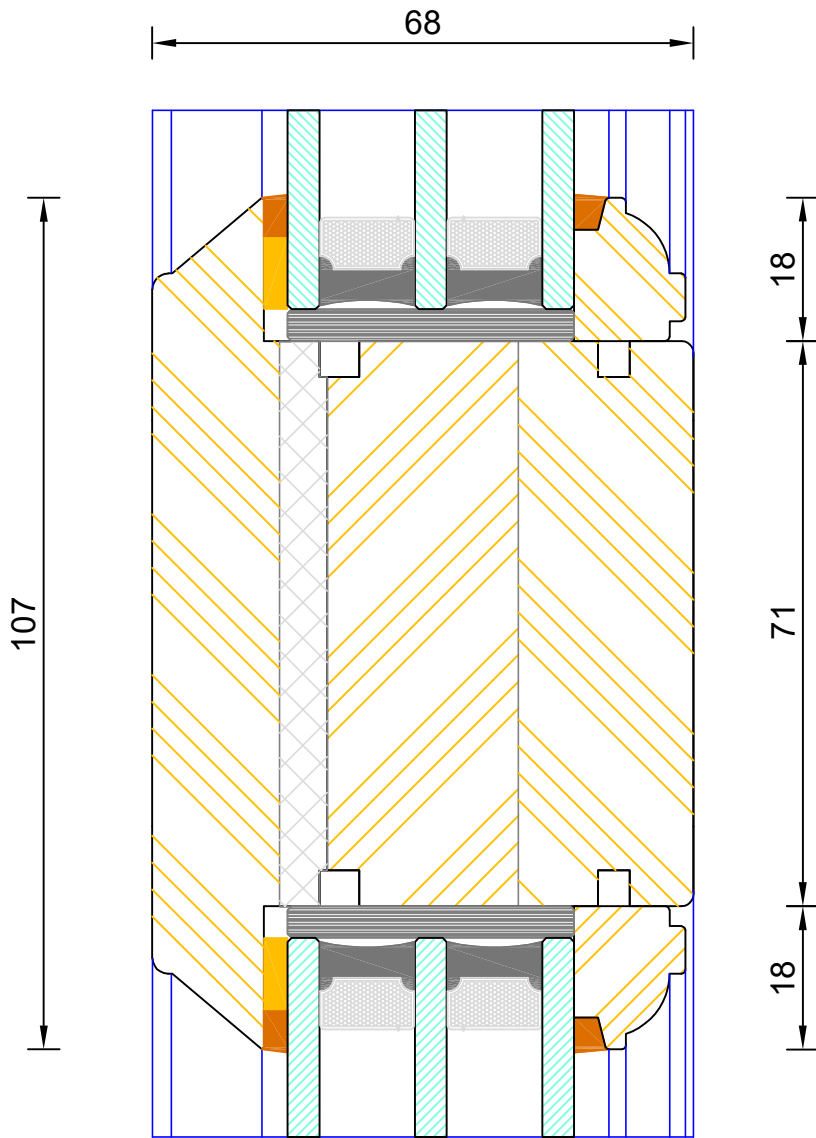

**Traditional Open In Flush Entrance Door**  
**Triple Glazed - Mid Rail (107mm)**

DIMENSIONS	PLOT SIZE	SCALE	DATE	REV	DWG NO.
MM	A4	1:1	10.08.2022	A	<b>2366</b>
Please consider the environment before printing					

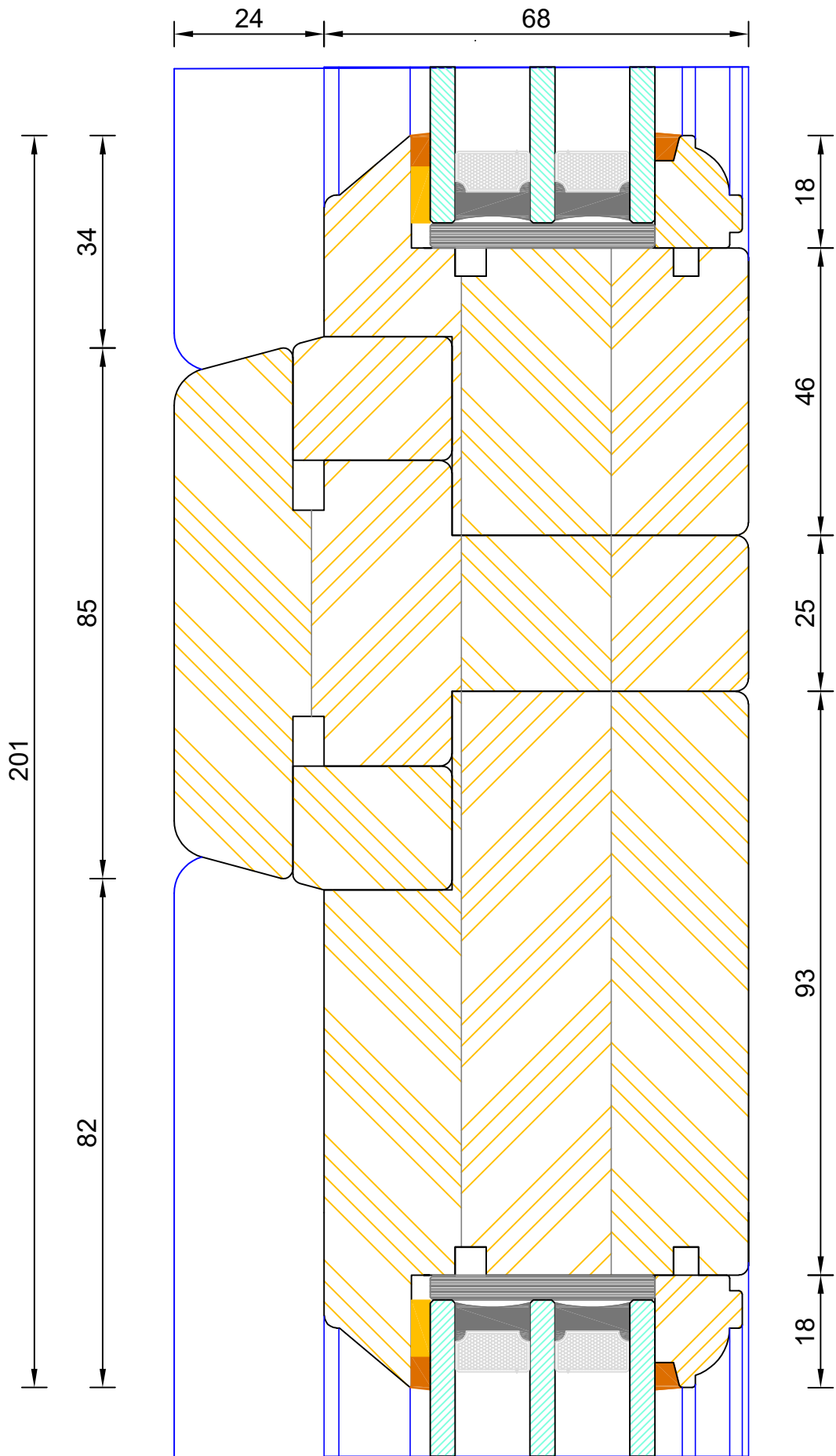
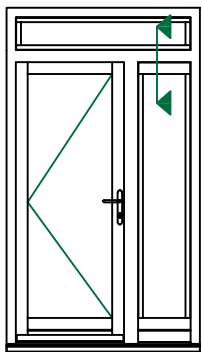

**Traditional Open In Flush Entrance Door**  
**Triple Glazed - Solid Transom (Fanlight / Sidelight)**

DIMENSIONS	PLOT SIZE	SCALE	DATE	REV	DWG NO.
MM	A4	1:1	10.08.2022	A	<b>2367</b>
Please consider the environment before printing					

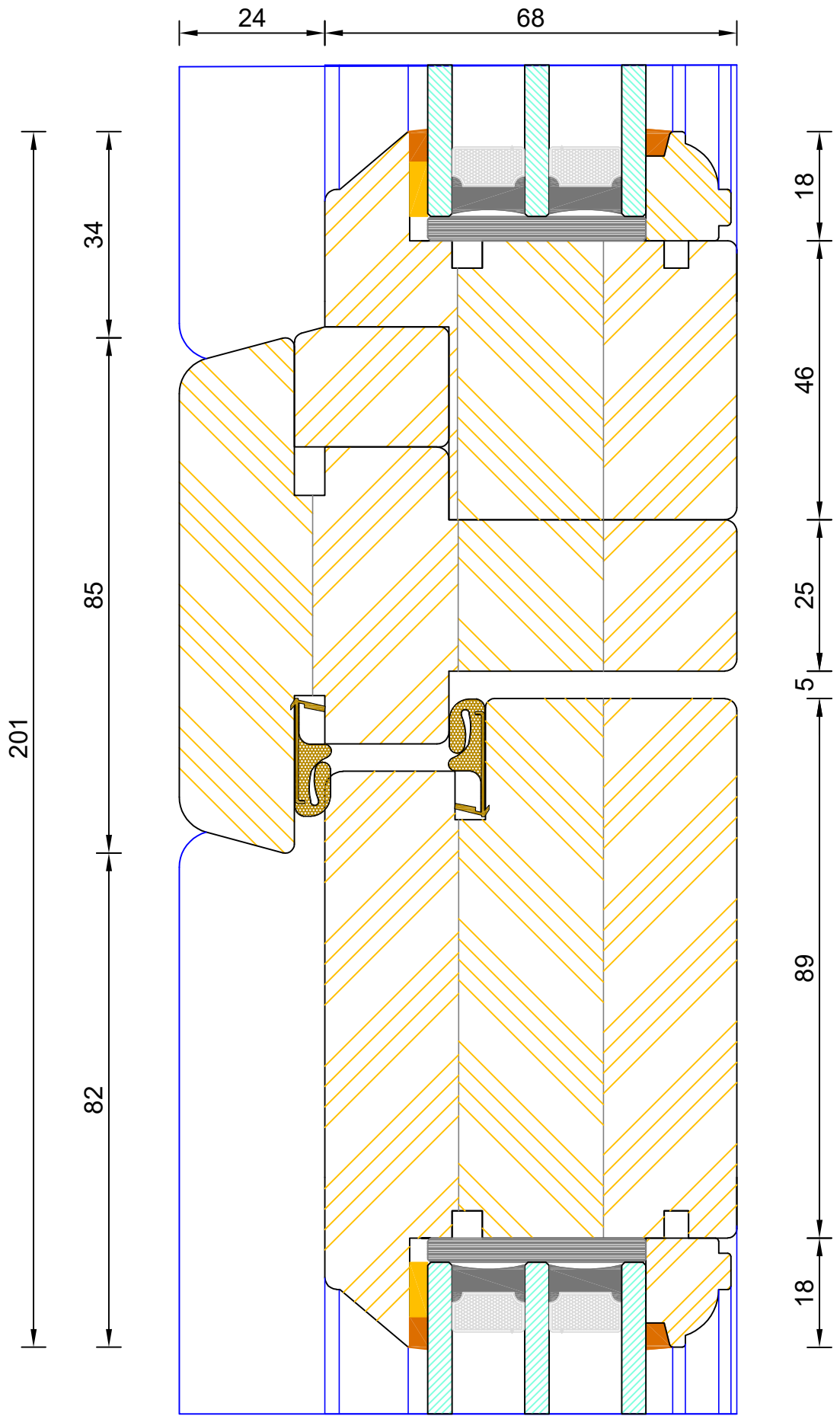
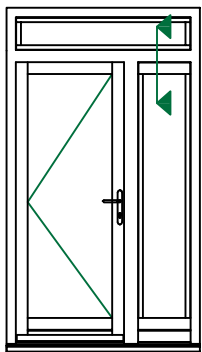

**Traditional Open In Flush Entrance Door**  
 Triple Glazed - Solid Transom (Fanlight / Door Leaf)

DIMENSIONS	PLOT SIZE	SCALE	DATE	REV	DWG NO.
MM	A4	1:1	10.08.2022	A	<b>2368</b>
Please consider the environment before printing					



# Bereco

## Traditional Open In Flush Entrance Door Triple Glazed - Solid Mullion (Fixed Light / Fixed Light)

DIMENSIONS	PLOT SIZE	SCALE	DATE	REV	DWG. NO.
MM	A1	1:1	10.08.2022	A	2369

Please consider the environment before printing

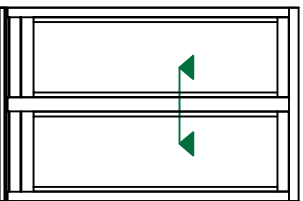
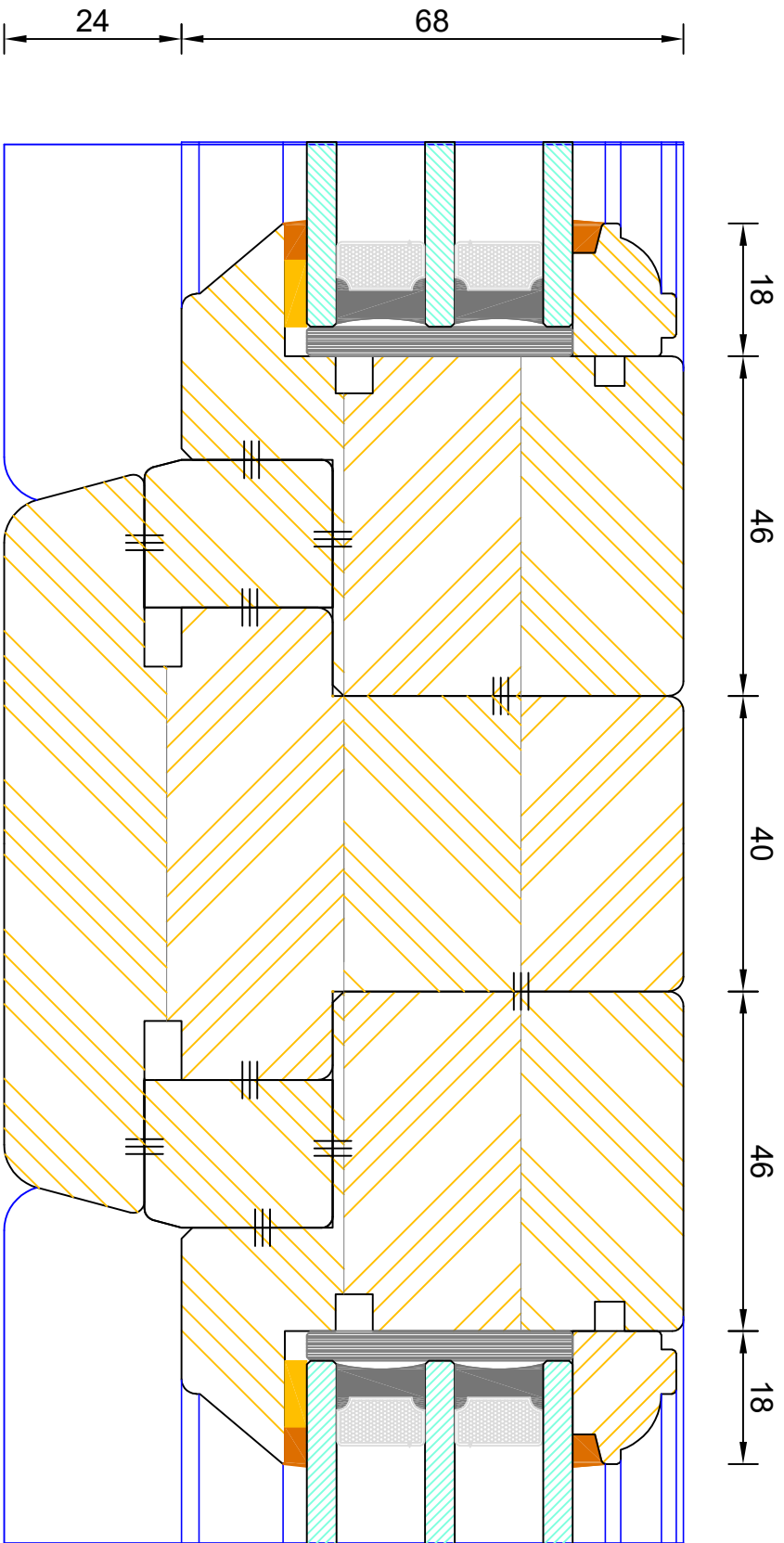



# Berenco

## Traditional Open In Flush Entrance Door Triple Glazed - Solid Mullion (Leaf / Side Light)

DIMENSIONS	PLOT SIZE	SCALE	DATE	REV	DWG. NO.
MM	A1	1:1	10.08.2022	A	2370

Please consider the environment before printing

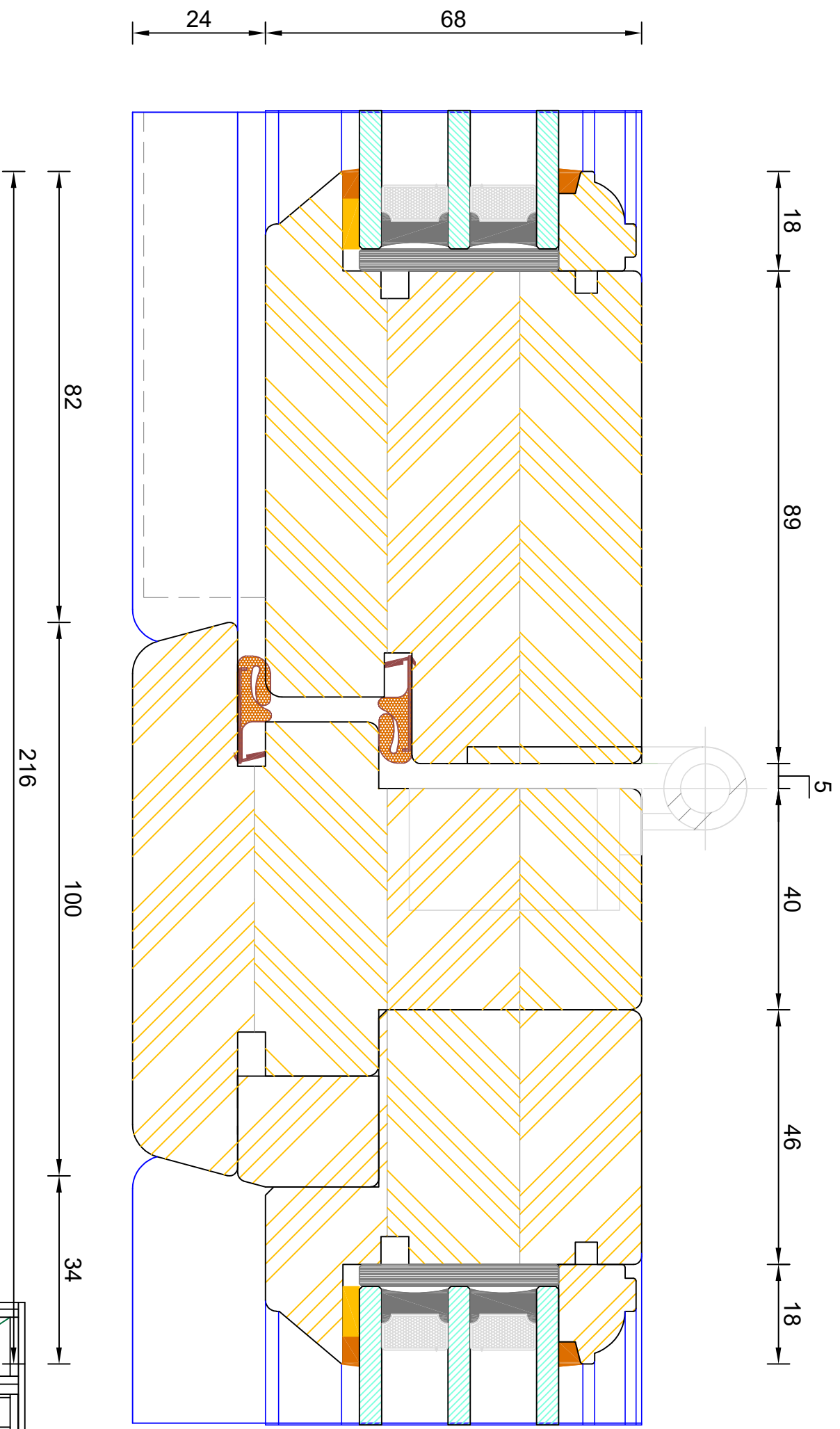
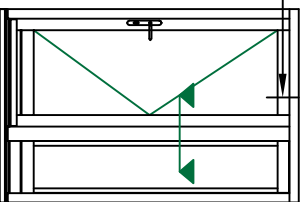



# Berenco

## Traditional Open In Flush Entrance Door Triple Glazed - Solid Mullion (Leaf / Side Light)

DIMENSIONS	PLOT SIZE	SCALE	DATE	REV	DWG NO.
MM	A1	1:1	10.08.2022	A	2371

Please consider the environment before printing

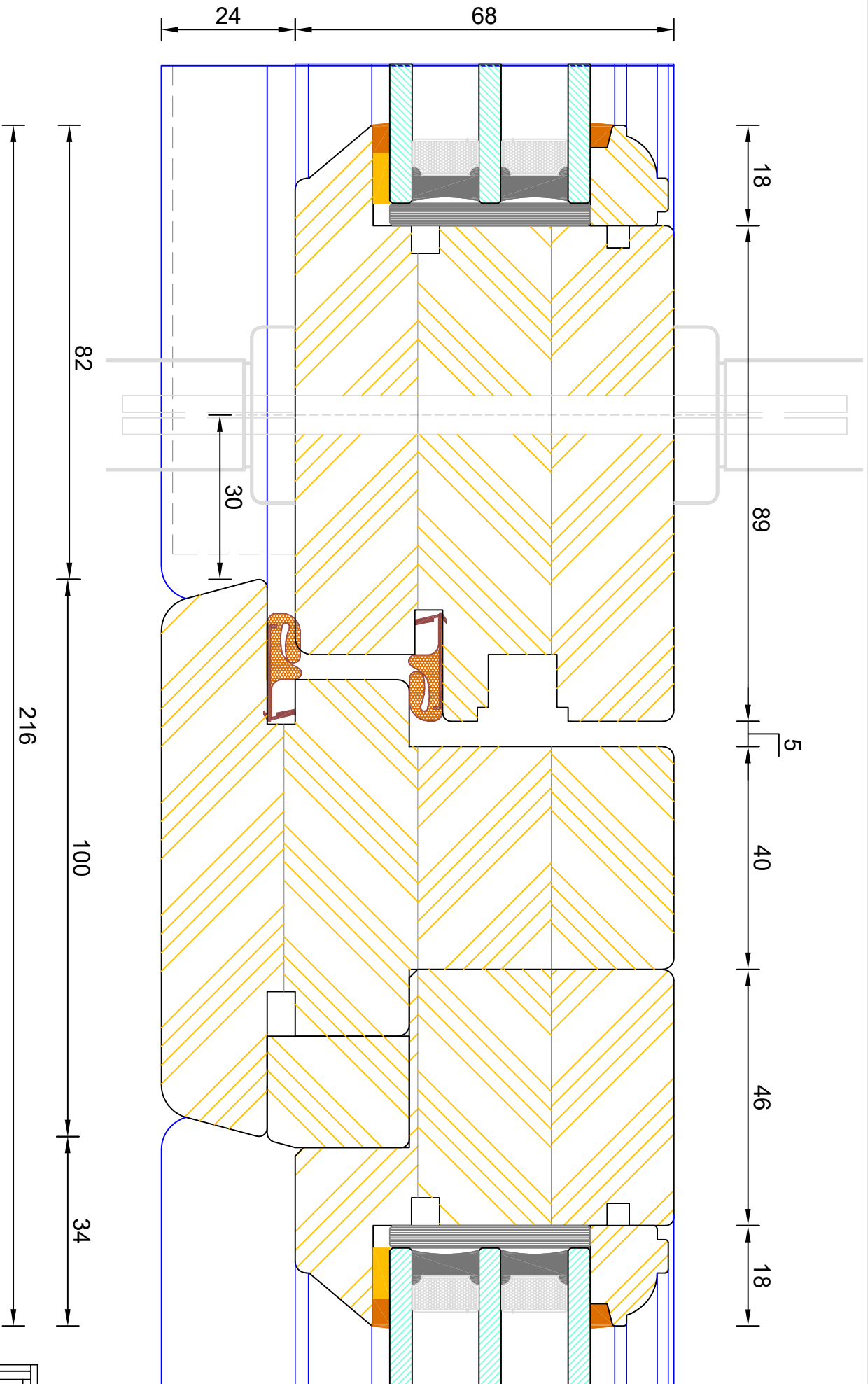
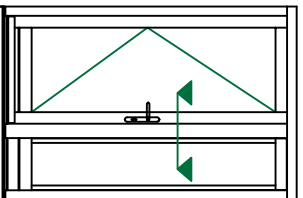

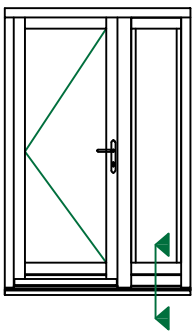
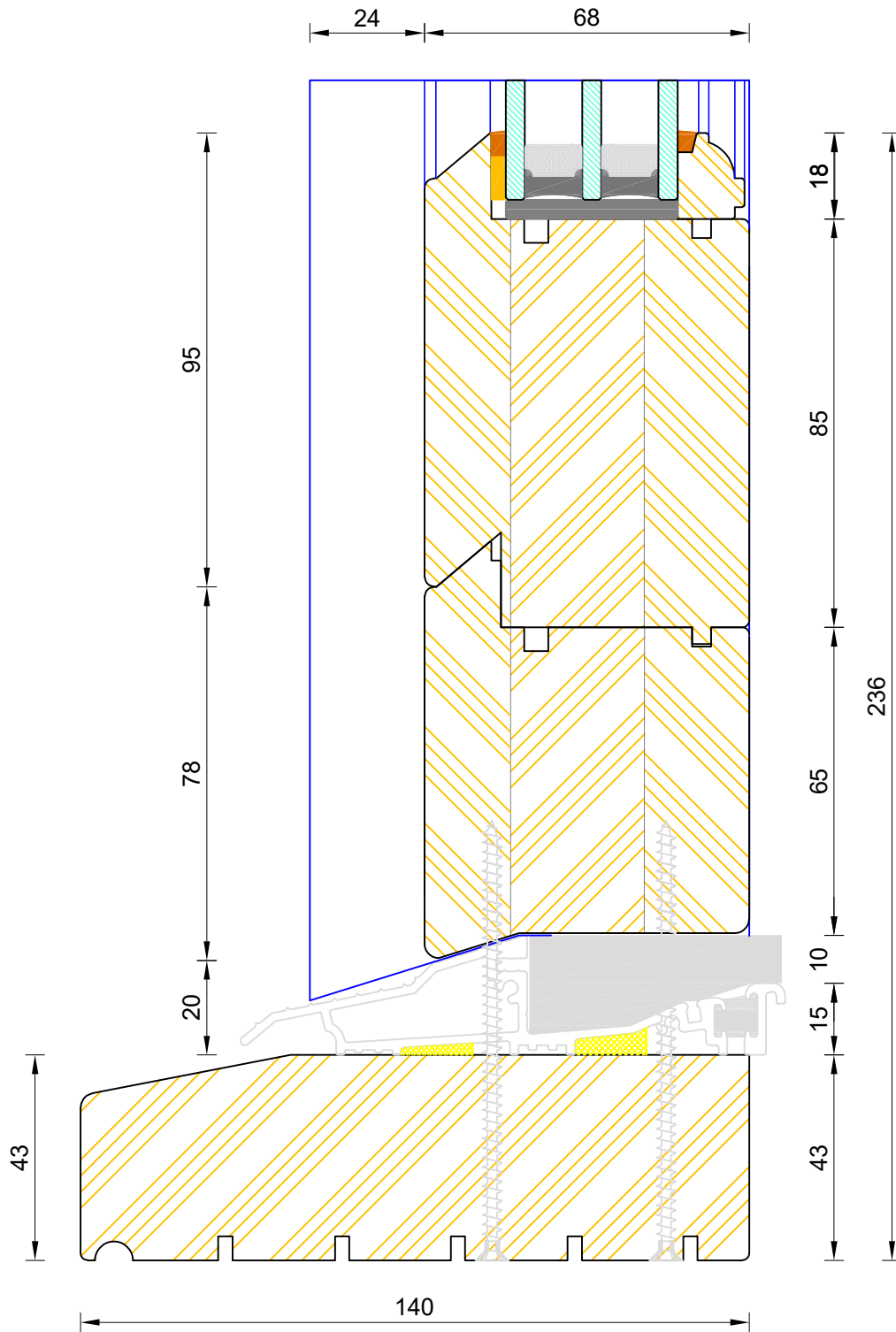

If not otherwise stated, Hardwood Threshold will be stained 5064 Walnut.



**Traditional Open In Flush Entrance Door**  
**Triple Glazed - Standard Thresh (Sidelight)**

DIMENSIONS	PLOT SIZE	SCALE	DATE	REV	DWG NO.
MM	A3	1:1	10.08.2022	A	<b>2356</b>

Please consider the environment before printing



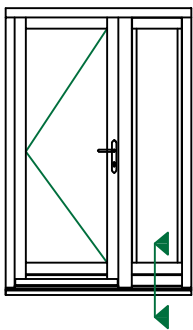
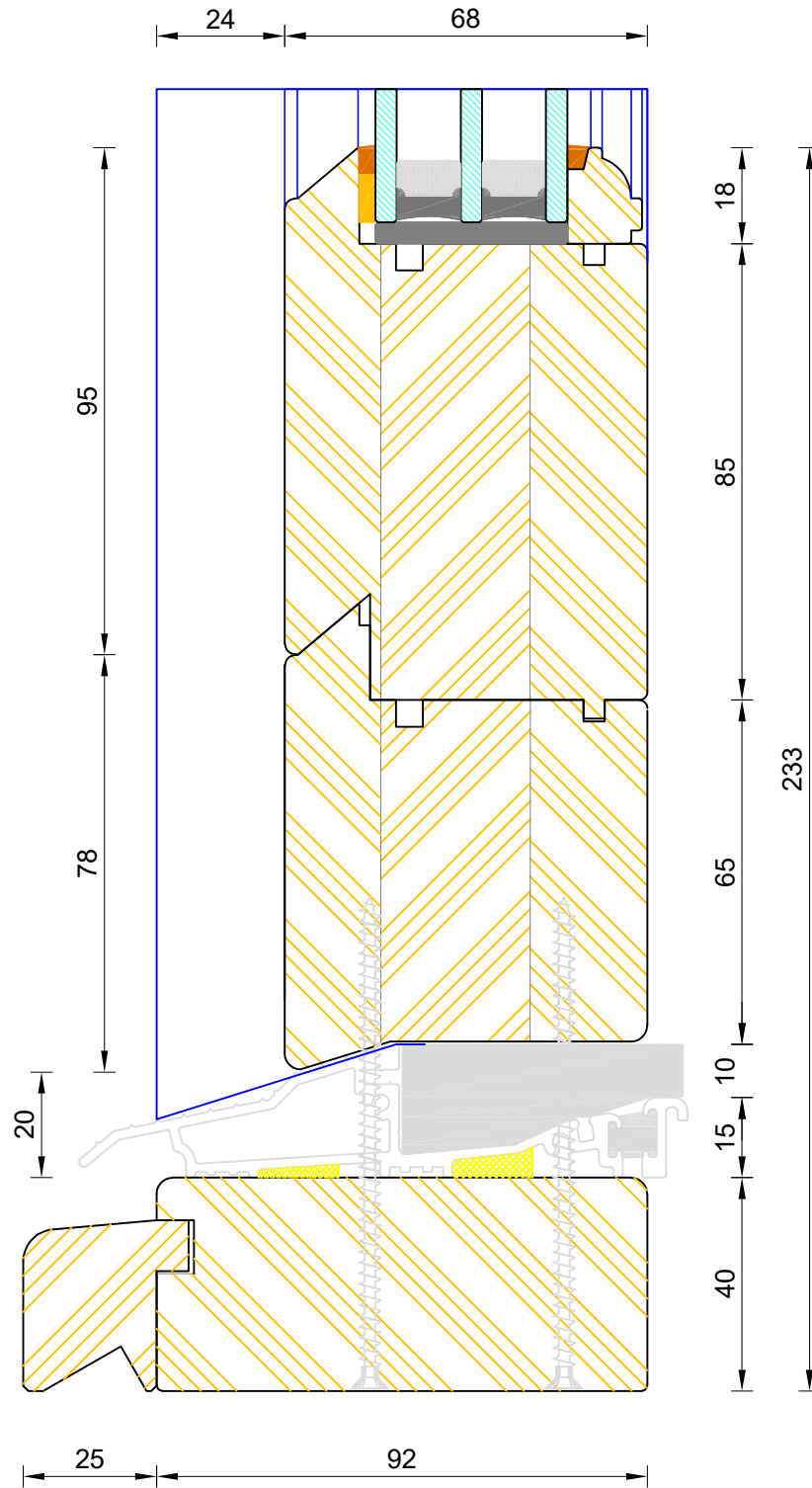

CILL EXTENSION - available options: 25mm (117mm o/a) / 47mm (139mm o/a) / 62mm (154mm o/a) / 87mm (179mm o/a) / 114mm (206mm o/a) / 125mm (217mm o/a) / 140mm (232mm o/a)

NOTE: Cill Extensions should be supported from underneath; the maximum overhang over Brick / Blockwork for cill extension should not exceed 25mm in order to avoid damage when stepped on. Warranties are invalidated when fitted with overhang in excess to that.

If not otherwise stated, Hardwood Threshold will be painted the same colour as Frame.



**Traditional Open In Flush Entrance Door**  
Triple Glazed - Coupling Thresh (Sidelight)

DIMENSIONS	PLOT SIZE	SCALE	DATE	REV	DWG NO.
MM	A3	1:1	10.08.2022	A	<b>2357</b>

Please consider the environment before printing

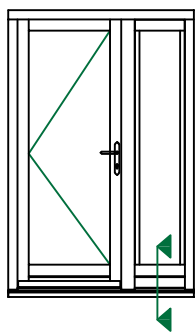
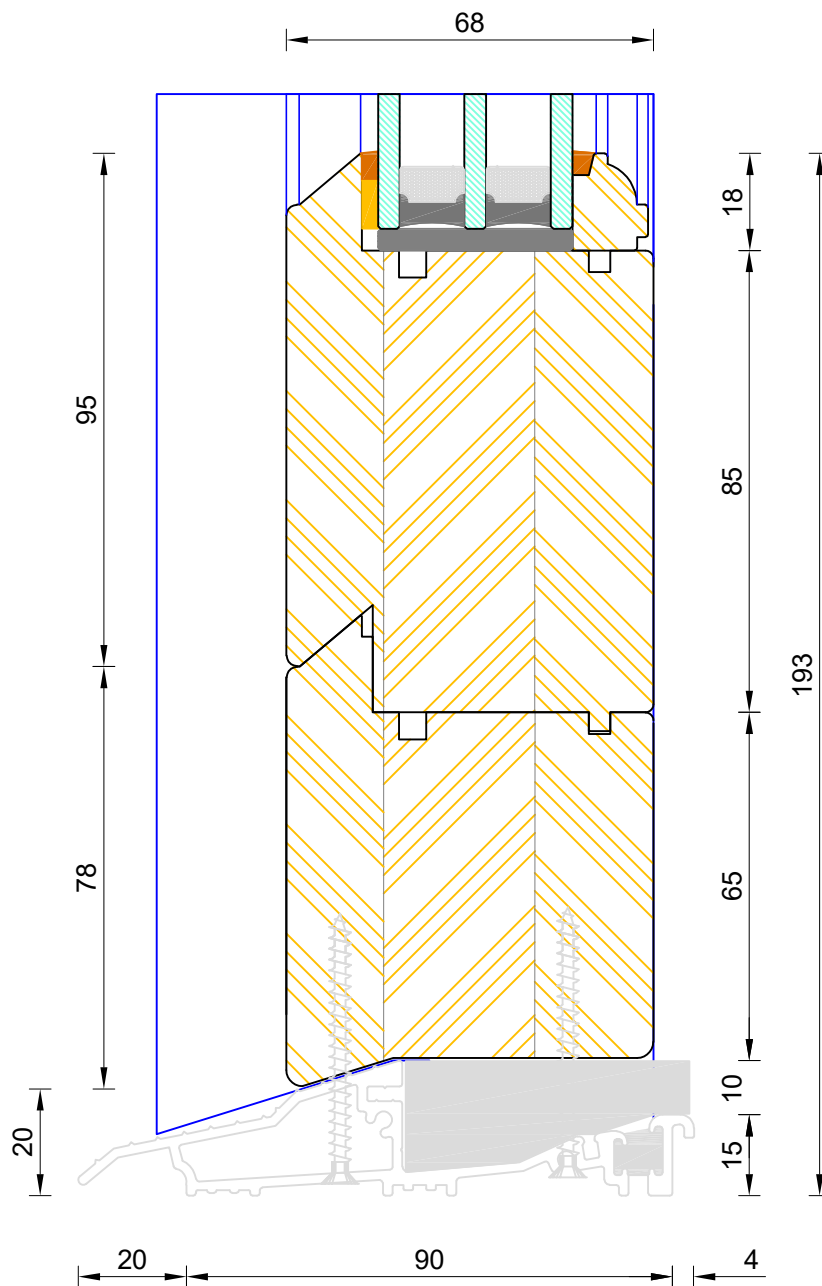

**Traditional Open In Flush Entrance Door**  
Triple Glazed - Mobility Thresh (Sidelight)

DIMENSIONS	PLOT SIZE	SCALE	DATE	REV	DWG NO.
MM	A3	1:1	10.08.2022	A	<b>2358</b>

Please consider the environment before printing

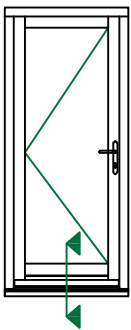
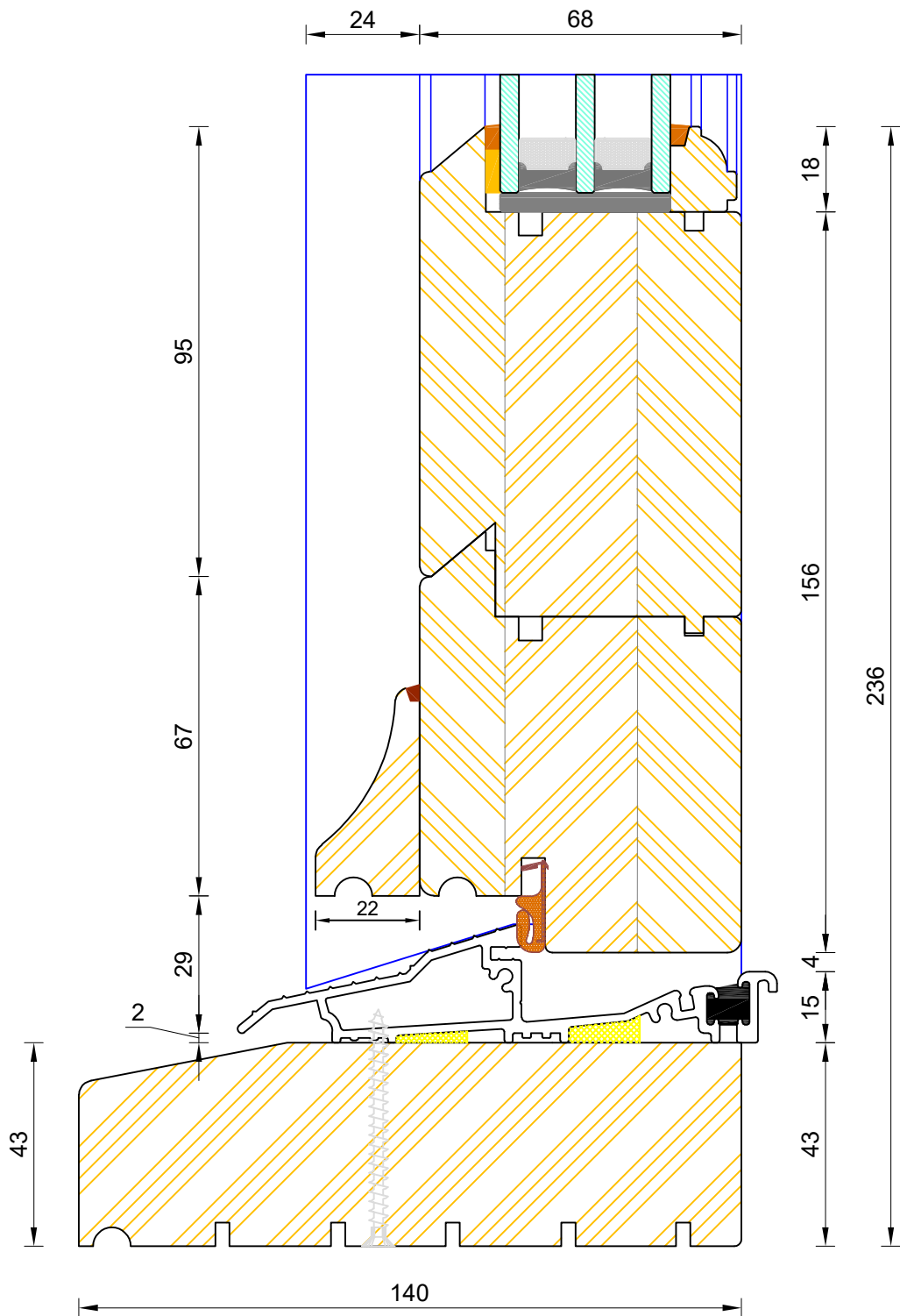

If not otherwise stated, Hardwood Threshold will be stained 5064 Walnut.



**Traditional Open In Flush Entrance Door**  
Triple Glazed - Standard Thresh (140x43mm)

DIMENSIONS	PLOT SIZE	SCALE	DATE	REV	DWG NO.
MM	A3	1:1	10.08.2022	A	<b>2362</b>
Please consider the environment before printing					

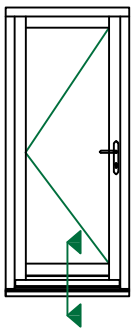
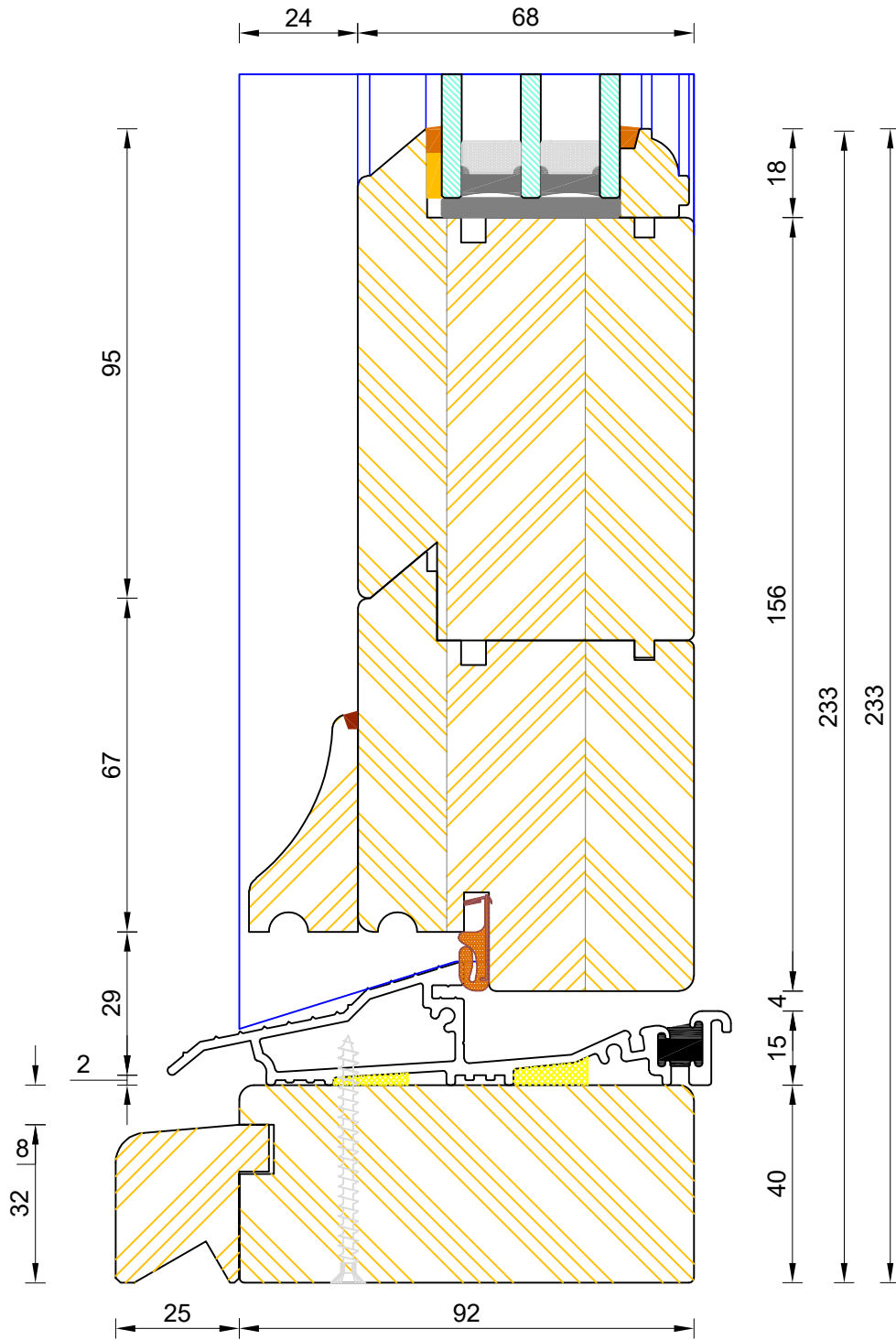

CILL EXTENSION - available options: 25mm (117mm o/a) / 47mm (139mm o/a) / 62mm (154mm o/a) / 87mm (179mm o/a) / 114mm (206mm o/a) / 125mm (217mm o/a) / 140mm (232mm o/a)

NOTE: Cill Extensions should be supported from underneath; the maximum overhang over Brick / Blockwork for cill extension should not exceed 25mm in order to avoid damage when stepped on. Warranties are invalidated when fitted with overhang in excess to that.

If not otherwise stated, Hardwood Threshold will be painted the same colour as Frame.



**Traditional Open In Flush Entrance Door**  
Triple Glazed - Coupling Thresh

DIMENSIONS	PLOT SIZE	SCALE	DATE	REV	DWG NO.
MM	A3	1:1	10.08.2022	A	<b>2363</b>
Please consider the environment before printing					

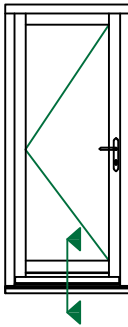
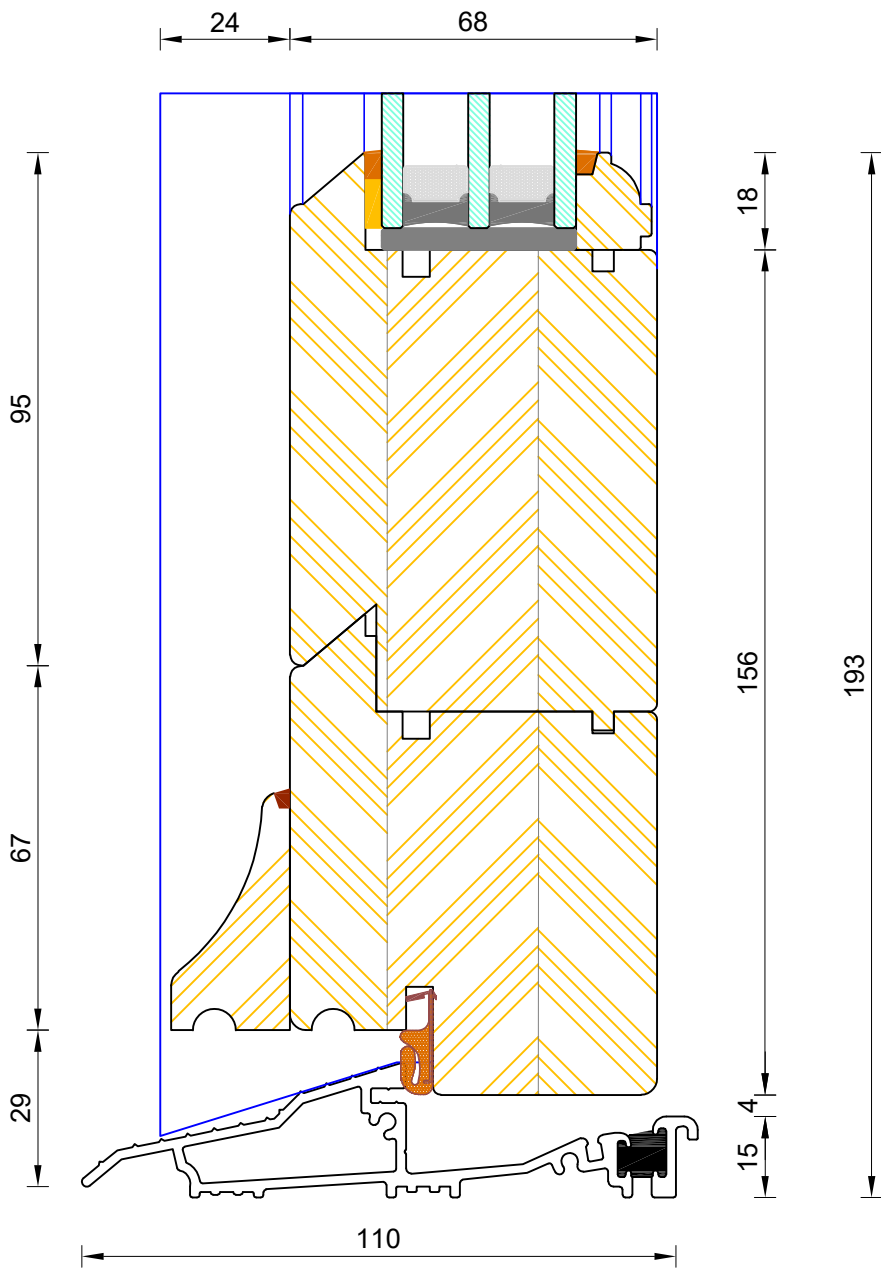

**Traditional Open In Flush Entrance Door**  
**Triple Glazed - Mobility Thresh**

DIMENSIONS	PLOT SIZE	SCALE	DATE	REV	DWG NO.
MM	A3	1:1	10.08.2022	A	<b>2364</b>

Please consider the environment before printing