

**Traditional Open Out Flush Entrance Door
Cill Extension Options**

DIMENSIONS	PLOT SIZE	SCALE	DATE	REV	DWG NO.
MM	A4	1:1	25.09.2019	B	2401

Please consider the environment before printing

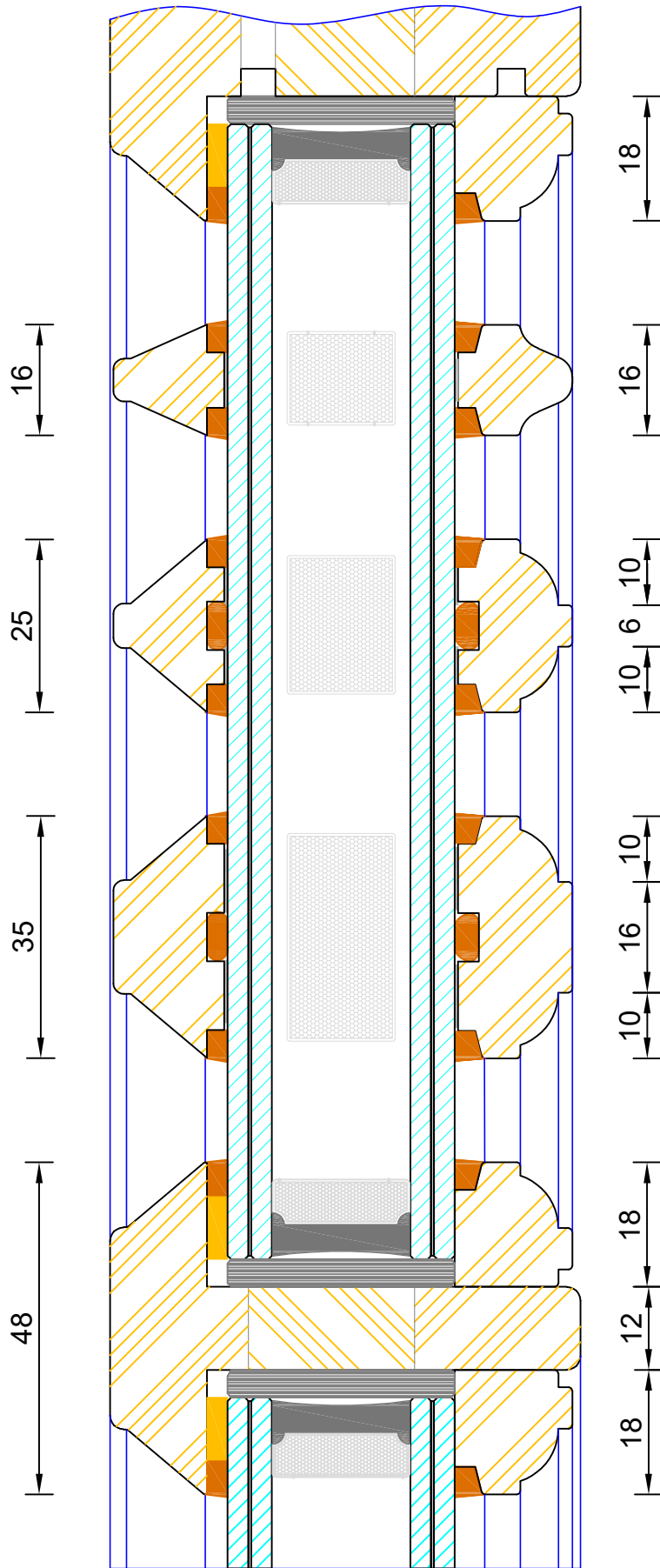

Traditional Open Out Flush Entrance Door Bar Options

DIMENSIONS	PLOT SIZE	SCALE	DATE	REV	DWG NO.
MM	A4	1:1	01.01.2019	B	2402
Please consider the environment before printing					

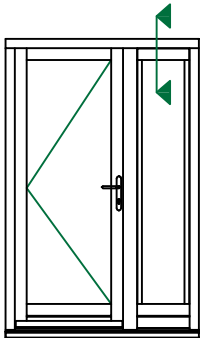
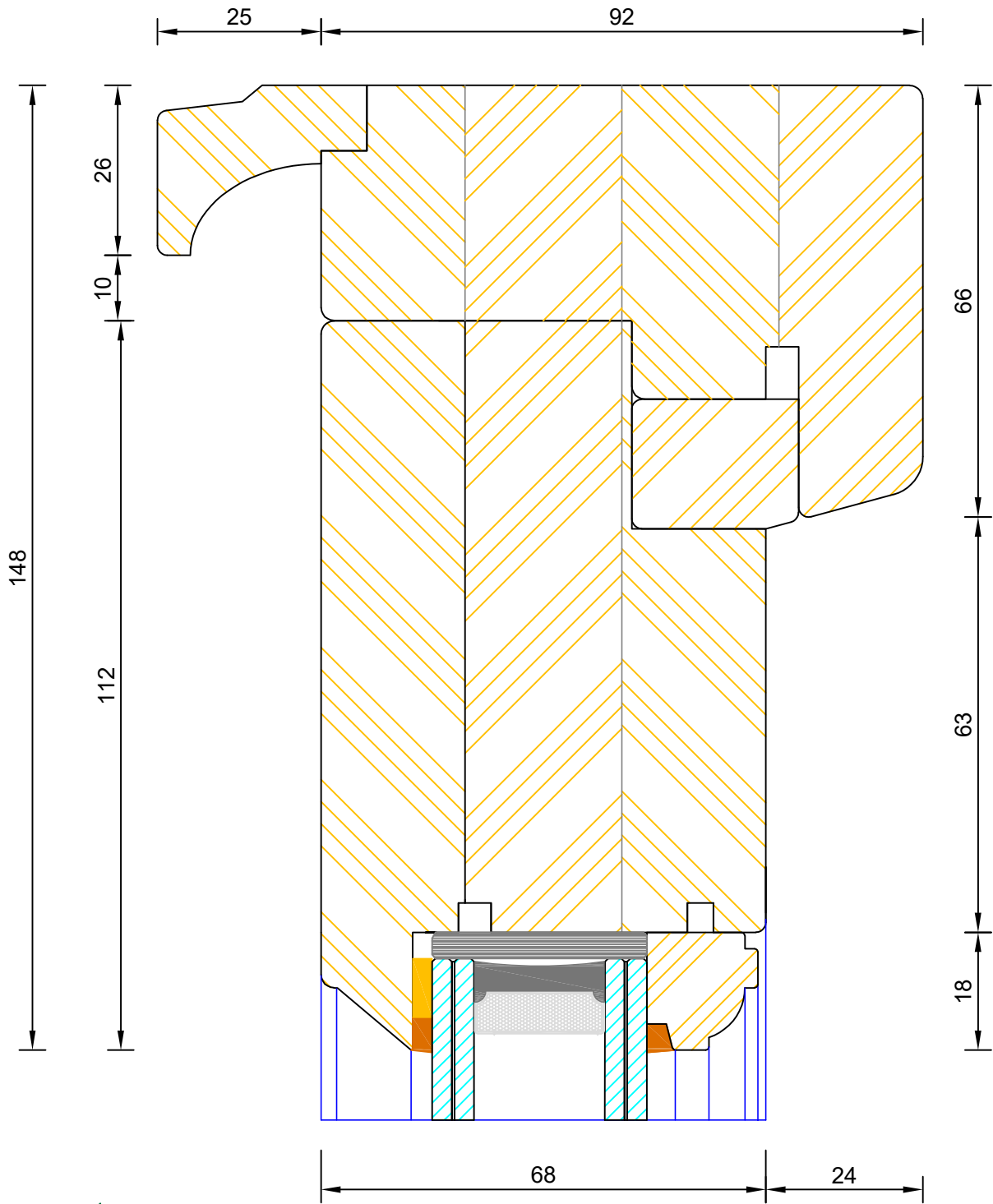

**Traditional Open Out Flush Entrance Door
Sidelight Head**

DIMENSIONS	PLOT SIZE	SCALE	DATE	REV	DWG NO.
MM	A4	1:1	10.08.2022	A	2403
 Please consider the environment before printing					

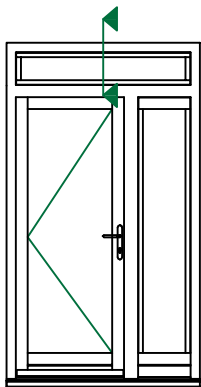
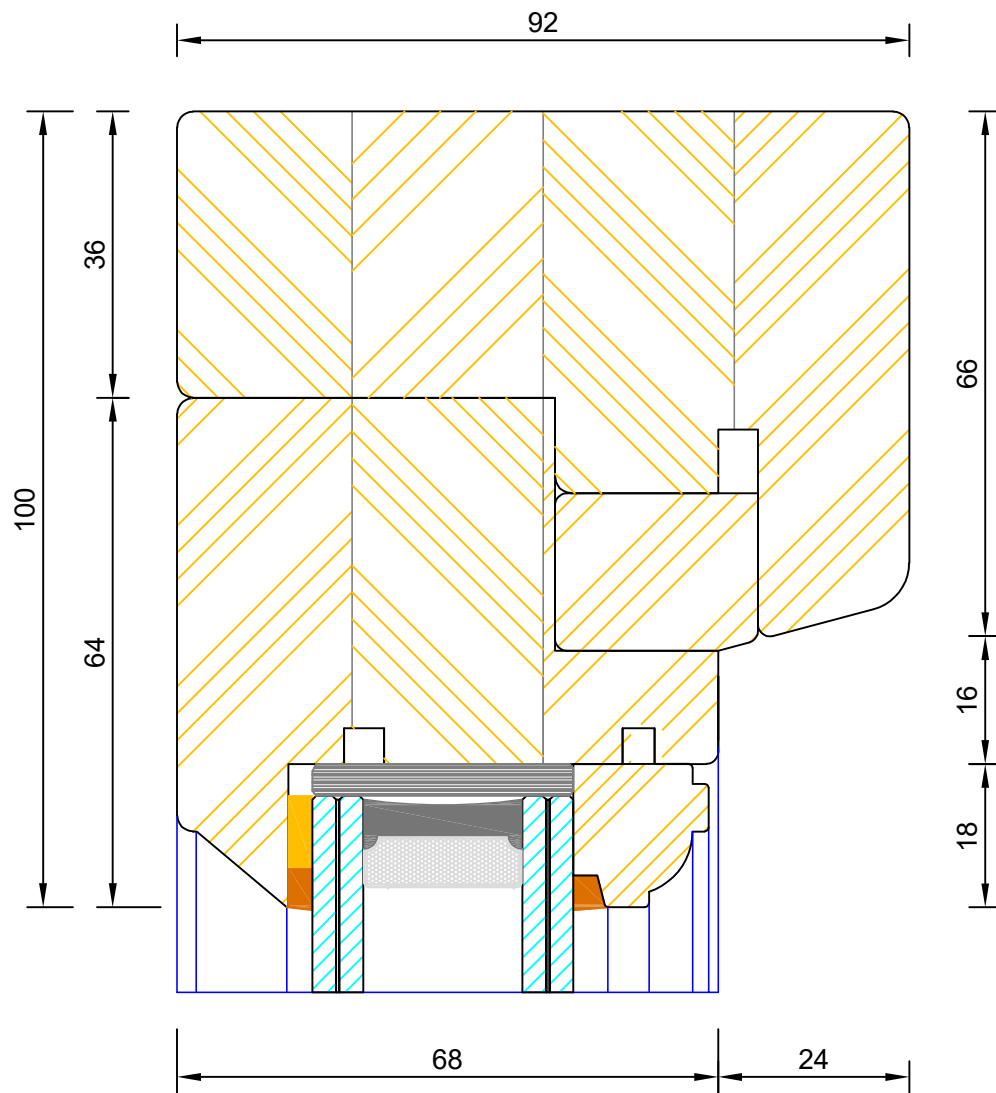

**Traditional Open Out Flush Entrance Door
Fanlight Head**

DIMENSIONS	PLOT SIZE	SCALE	DATE	REV	DWG NO.
MM	A4	1:1	10.08.2022	A	2404
Please consider the environment before printing					

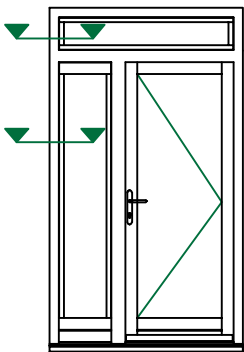
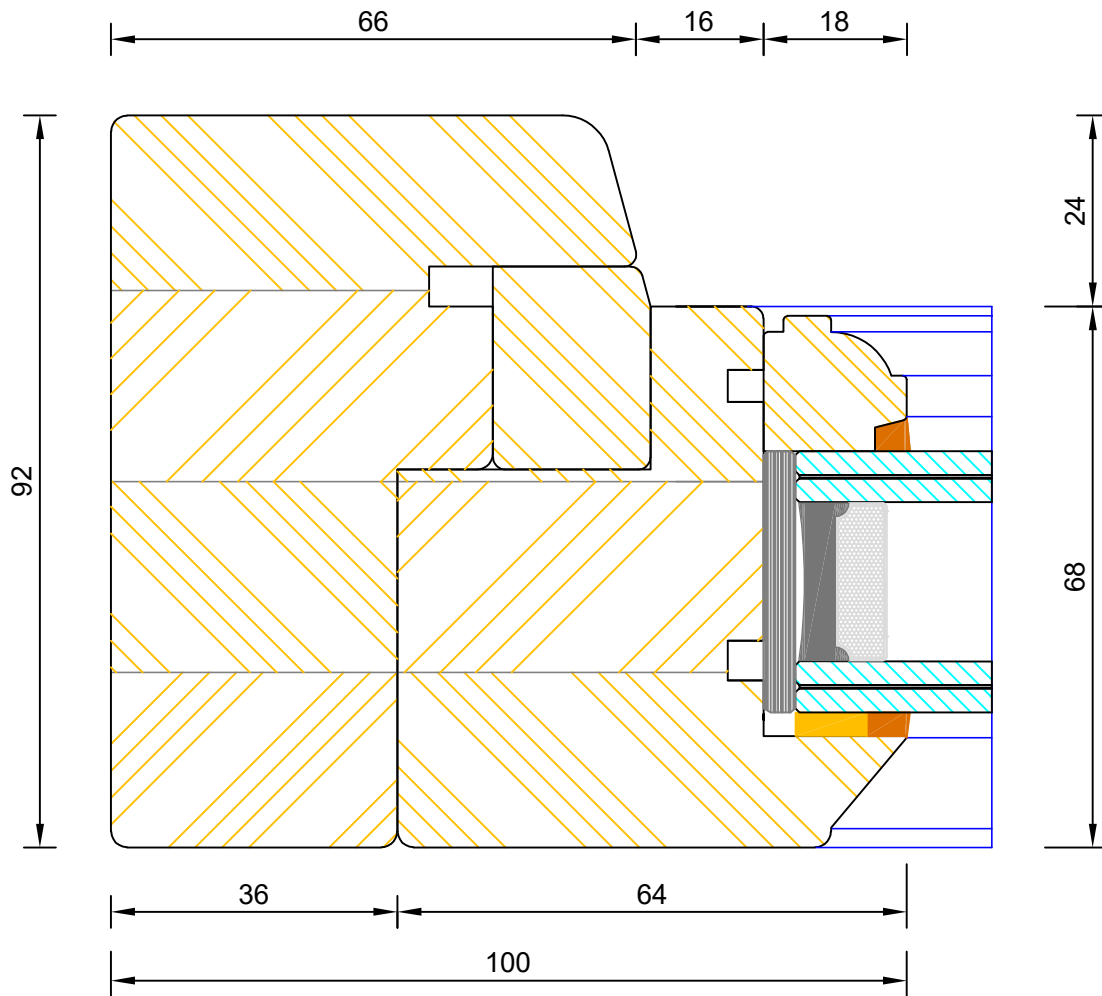

**Traditional Open Out Flush Entrance Door
Sidelight / Fanlight Jamb**

DIMENSIONS	PLOT SIZE	SCALE	DATE	REV	DWG NO.
MM	A4	1:1	10.08.2022	A	2405
Please consider the environment before printing					

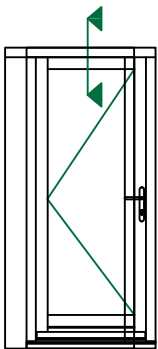
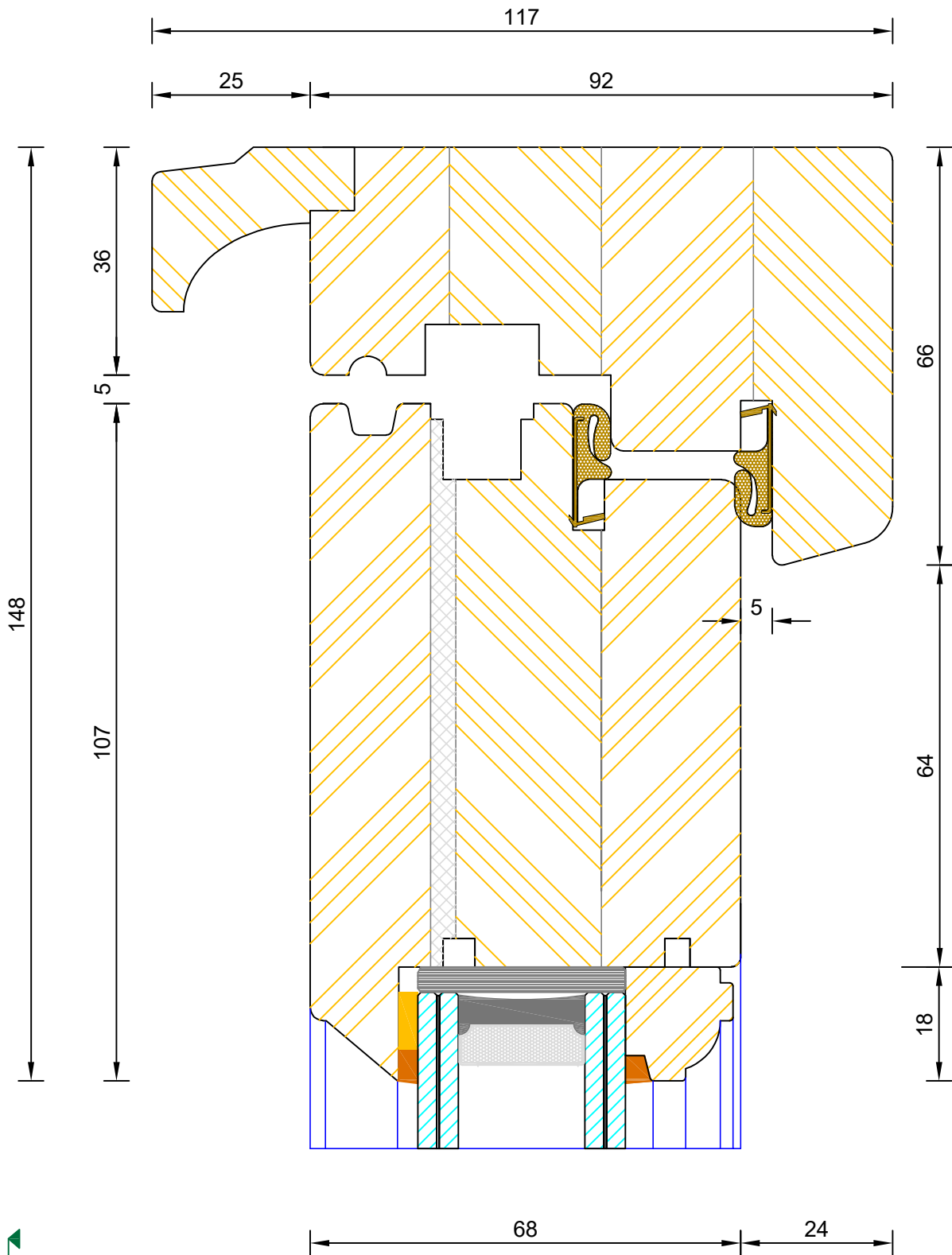

**Traditional Open Out Flush Entrance Door
Frame & Leaf Head**

DIMENSIONS	PLOT SIZE	SCALE	DATE	REV	DWG NO.
MM	A4	1:1	10.08.2022	A	2409
Please consider the environment before printing					

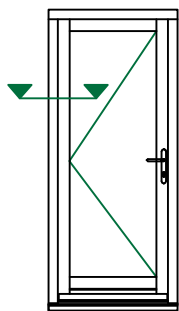
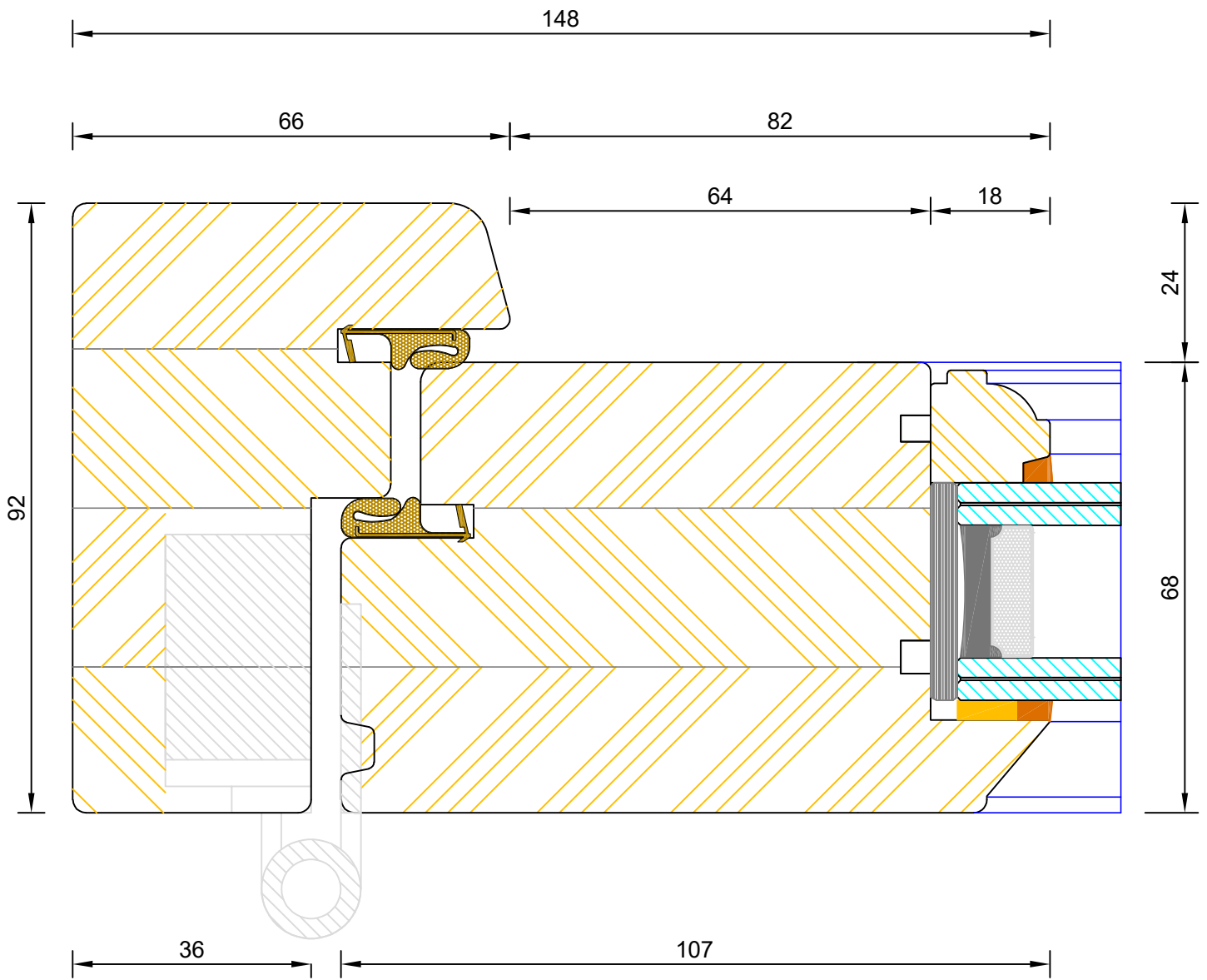

**Traditional Open Out Flush Entrance Door
Frame & Leaf Jamb (Hinge Side)**

DIMENSIONS	PLOT SIZE	SCALE	DATE	REV	DWG NO.
MM	A4	1:1	10.08.2022	A	2410

Please consider the environment before printing

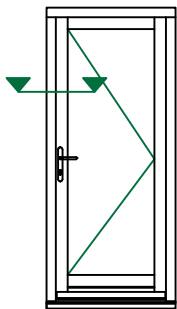
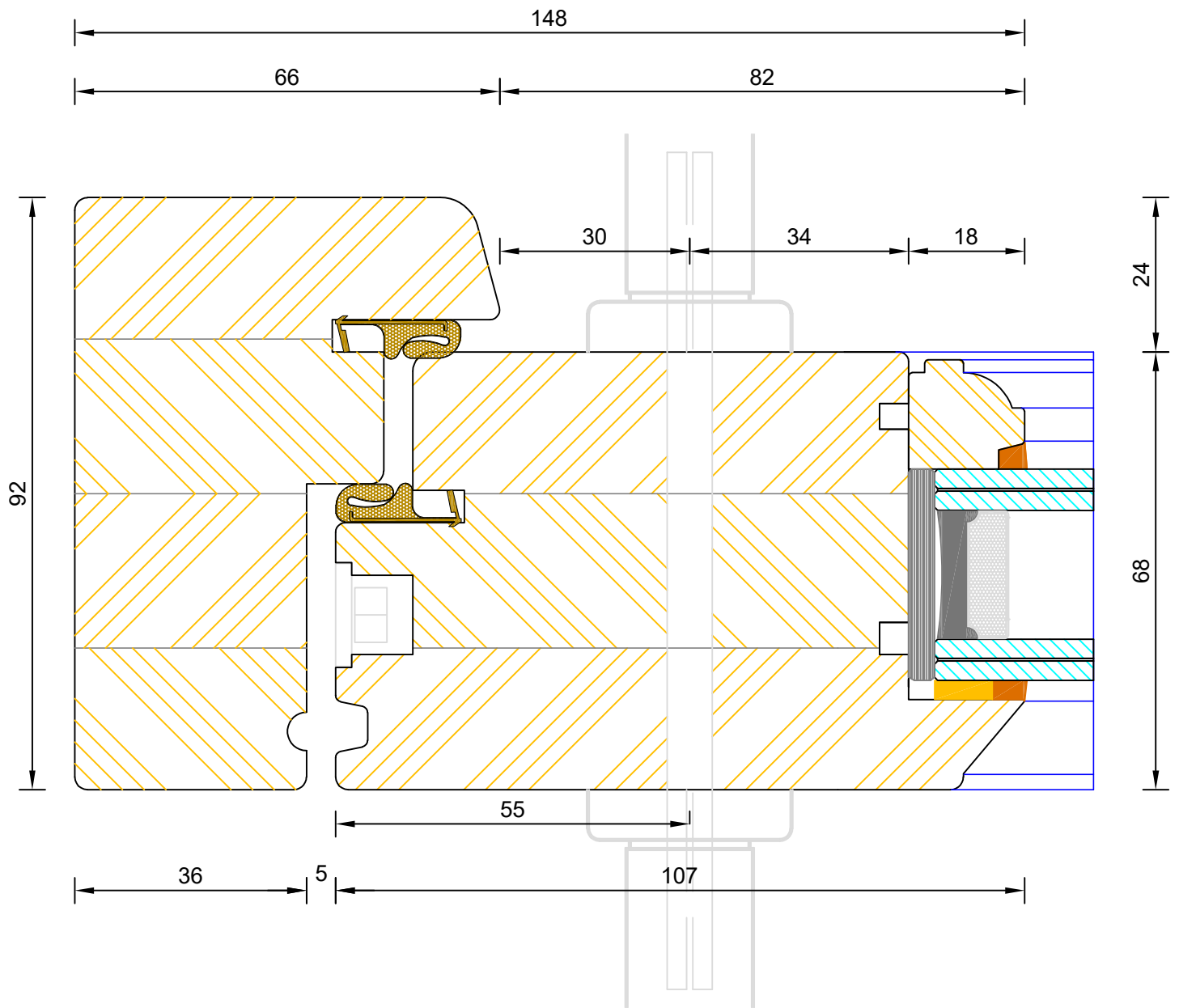

**Traditional Open Out Flush Entrance Door
Frame & Leaf Jamb (Handle Side)**

DIMENSIONS	PLOT SIZE	SCALE	DATE	REV	DWG NO.
MM	A4	1:1	10.08.2022	A	2411
Please consider the environment before printing					

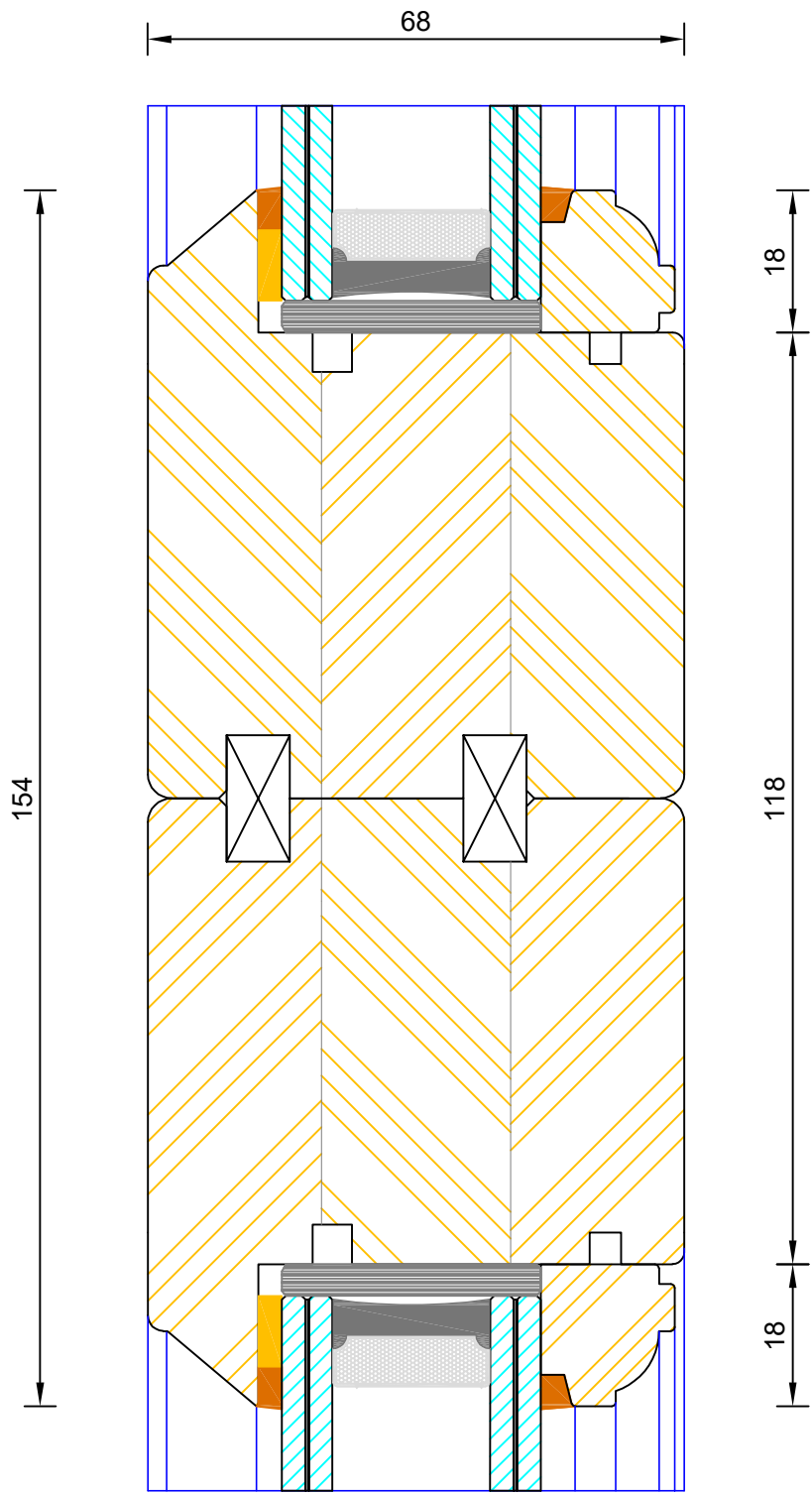
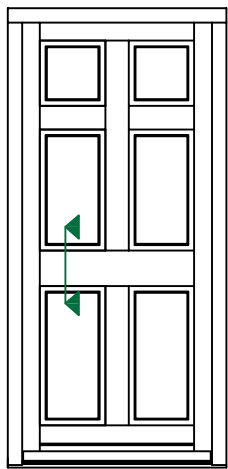

**Traditional Open Out Flush Entrance Door
Mid Rail (Optional 154mm)**

DIMENSIONS	PLOT SIZE	SCALE	DATE	REV	DWG NO.
MM	A4	1:1	10.08.2022	A	2416
Please consider the environment before printing					

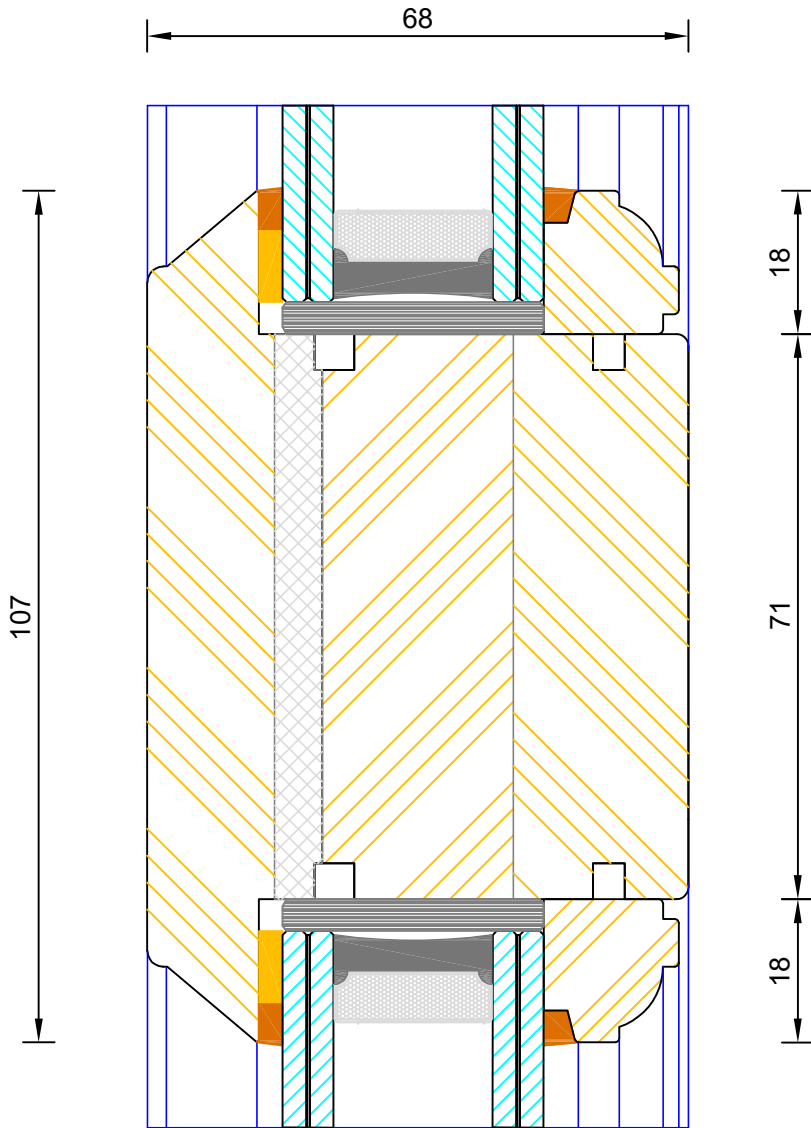
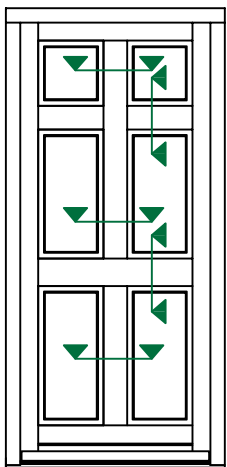

**Traditional Open Out Flush Entrance Door
Mid Rail (107mm)**

DIMENSIONS	PLOT SIZE	SCALE	DATE	REV	DWG NO.
MM	A4	1:1	10.08.2022	A	2417
Please consider the environment before printing					

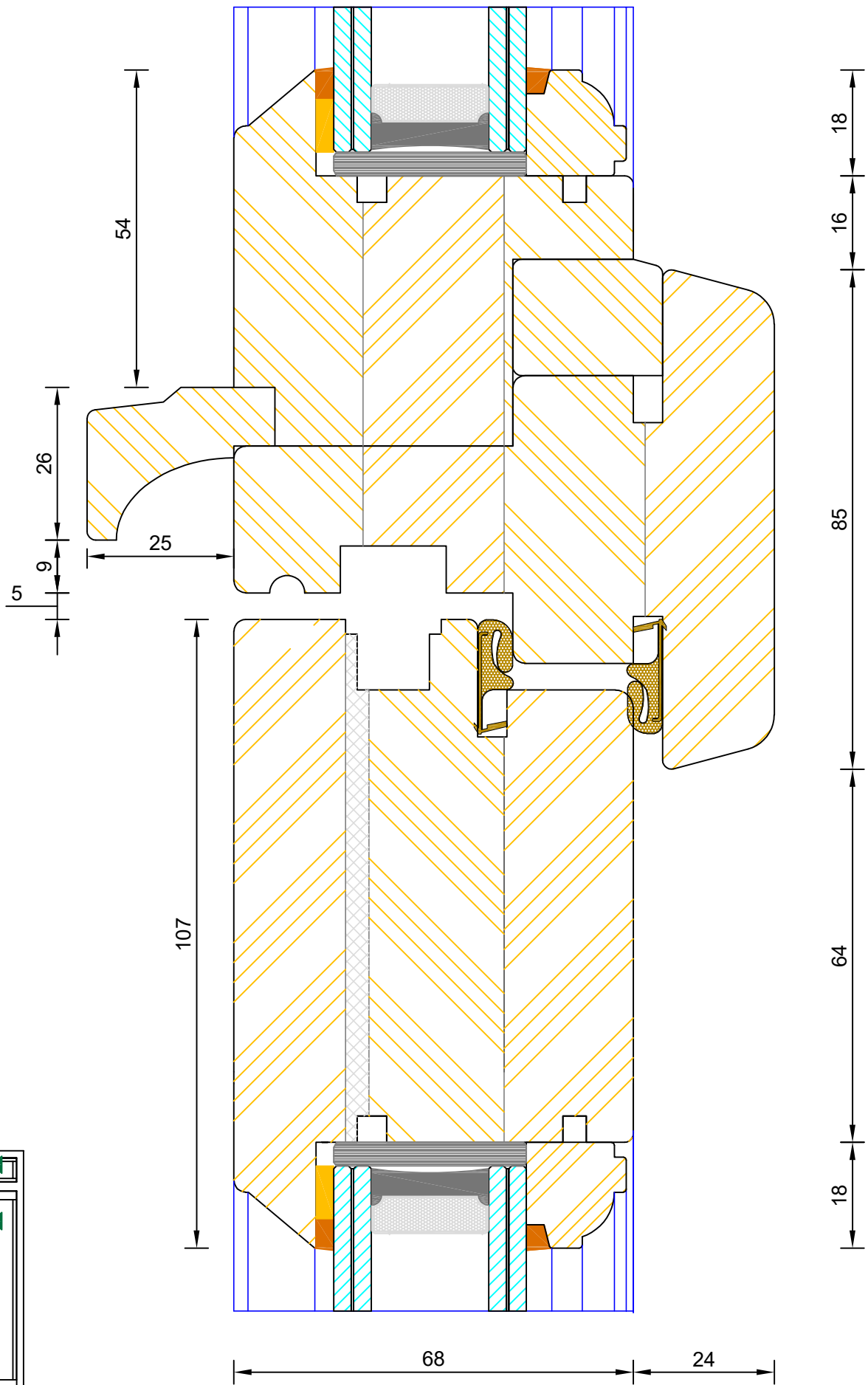
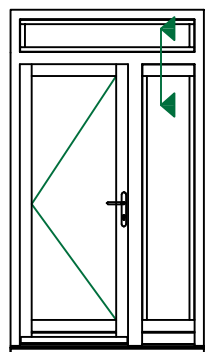

**Traditional Open Out Flush Entrance Door
Solid Transom (Fanlight / Door Leaf)**

DIMENSIONS	PLOT SIZE	SCALE	DATE	REV	DWG NO.
MM	A4	1:1	10.08.2022	A	2412
Please consider the environment before printing					

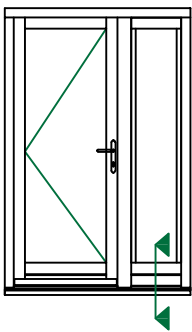
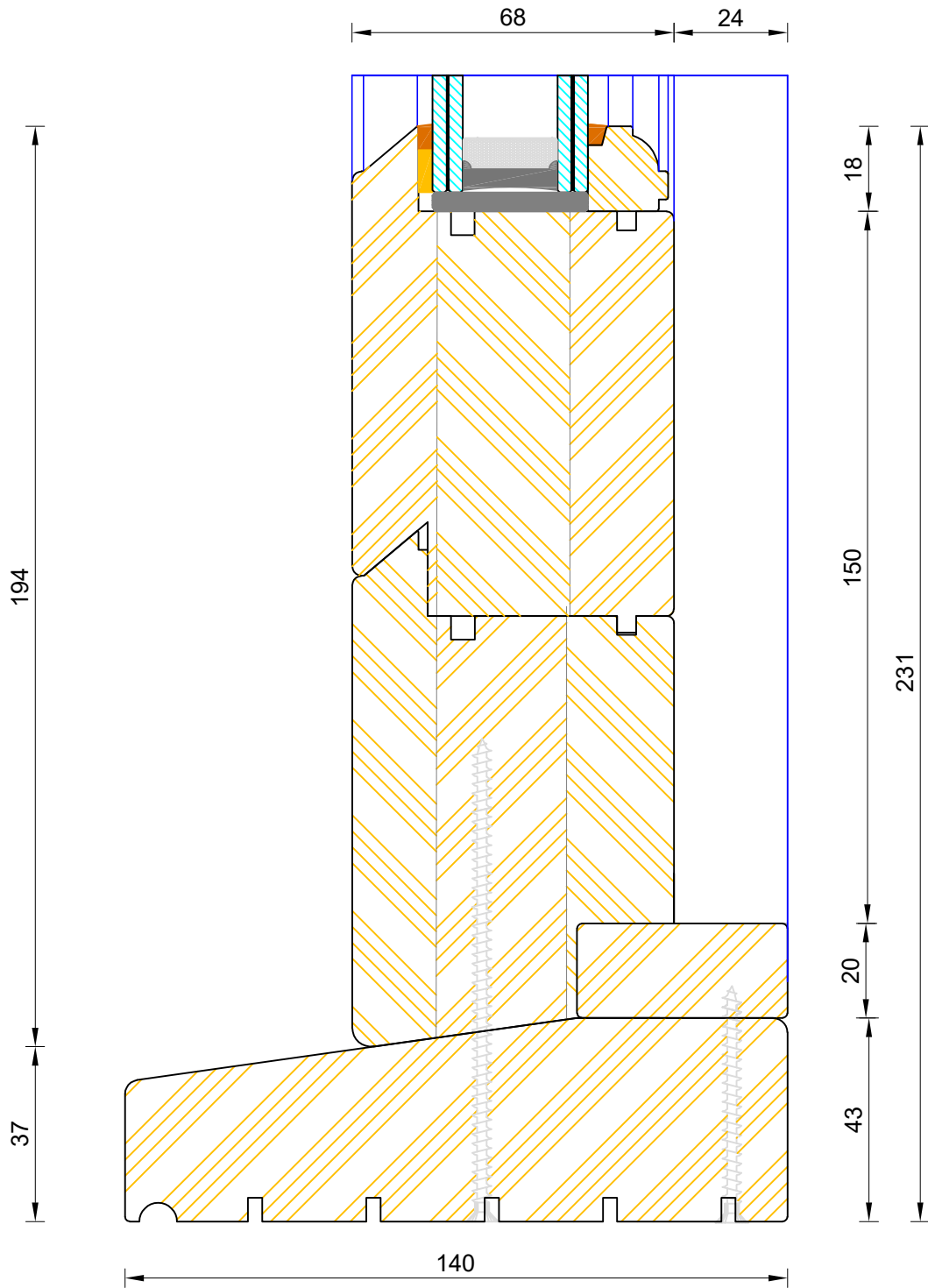

If not otherwise stated, Hardwood Threshold will be stained 5064 Walnut.



**Traditional Open Out Flush Entrance Door
Standard Thresh (Sidelight)**

DIMENSIONS	PLOT SIZE	SCALE	DATE	REV	DWG NO.
MM	A3	1:1	10.08.2022	A	2406
Please consider the environment before printing					

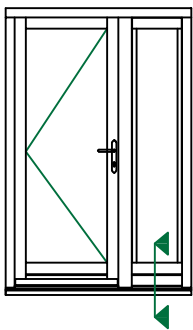
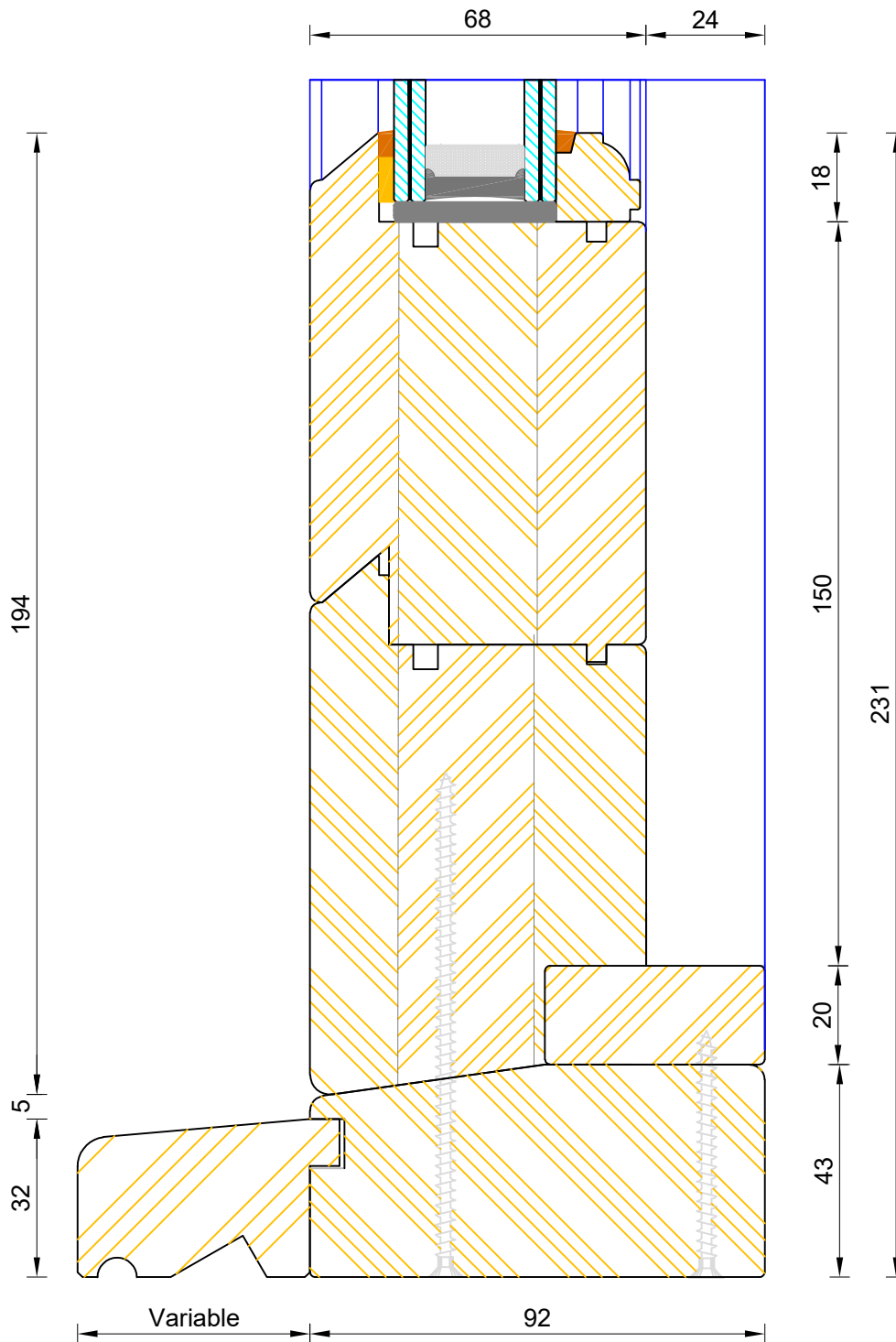

CILL EXTENSION - available options: 25mm (117mm o/a) / 47mm (139mm o/a) / 62mm (154mm o/a) / 87mm (179mm o/a) / 114mm (206mm o/a) / 125mm (217mm o/a) / 140mm (232mm o/a)

NOTE: Cill Extensions should be supported from underneath; the maximum overhang over Brick / Blockwork for cill extension should not exceed 25mm in order to avoid damage when stepped on. Warranties are invalidated when fitted with overhang in excess to that.

If not otherwise stated, Hardwood Threshold will be painted the same colour as Frame.



Traditional Open Out Flush Entrance Door Coupling Thresh (Sidelight)

DIMENSIONS	PLOT SIZE	SCALE	DATE	REV	DWG NO.
MM	A3	1:1	10.08.2022	A	2407
Please consider the environment before printing					

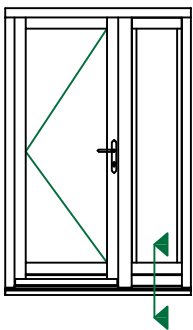
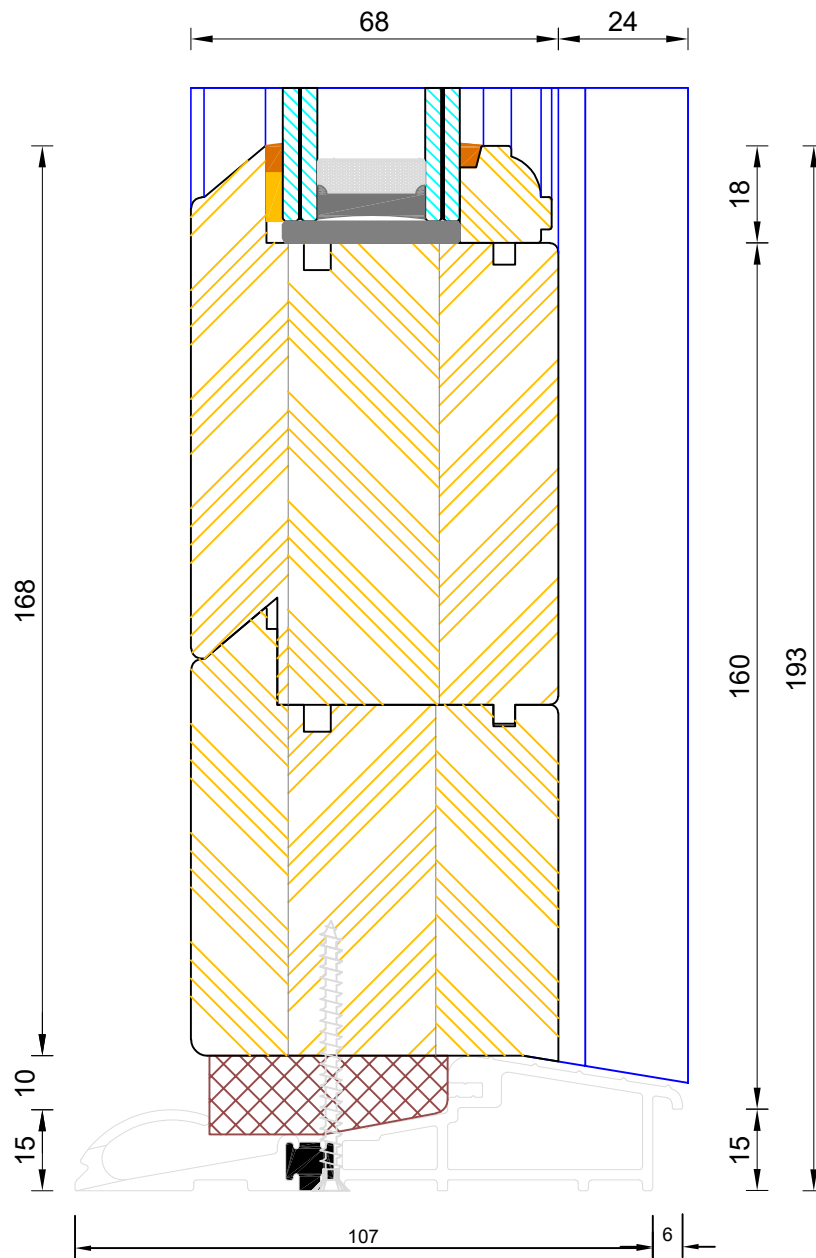

**Traditional Open Out Flush Entrance Door
Mobility Threshold (Sidelight)**

DIMENSIONS	PLOT SIZE	SCALE	DATE	REV	DWG NO.
MM	A3	1:1	10.08.2022	A	2408
Please consider the environment before printing					

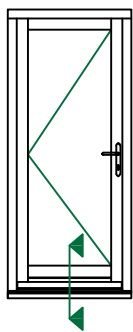
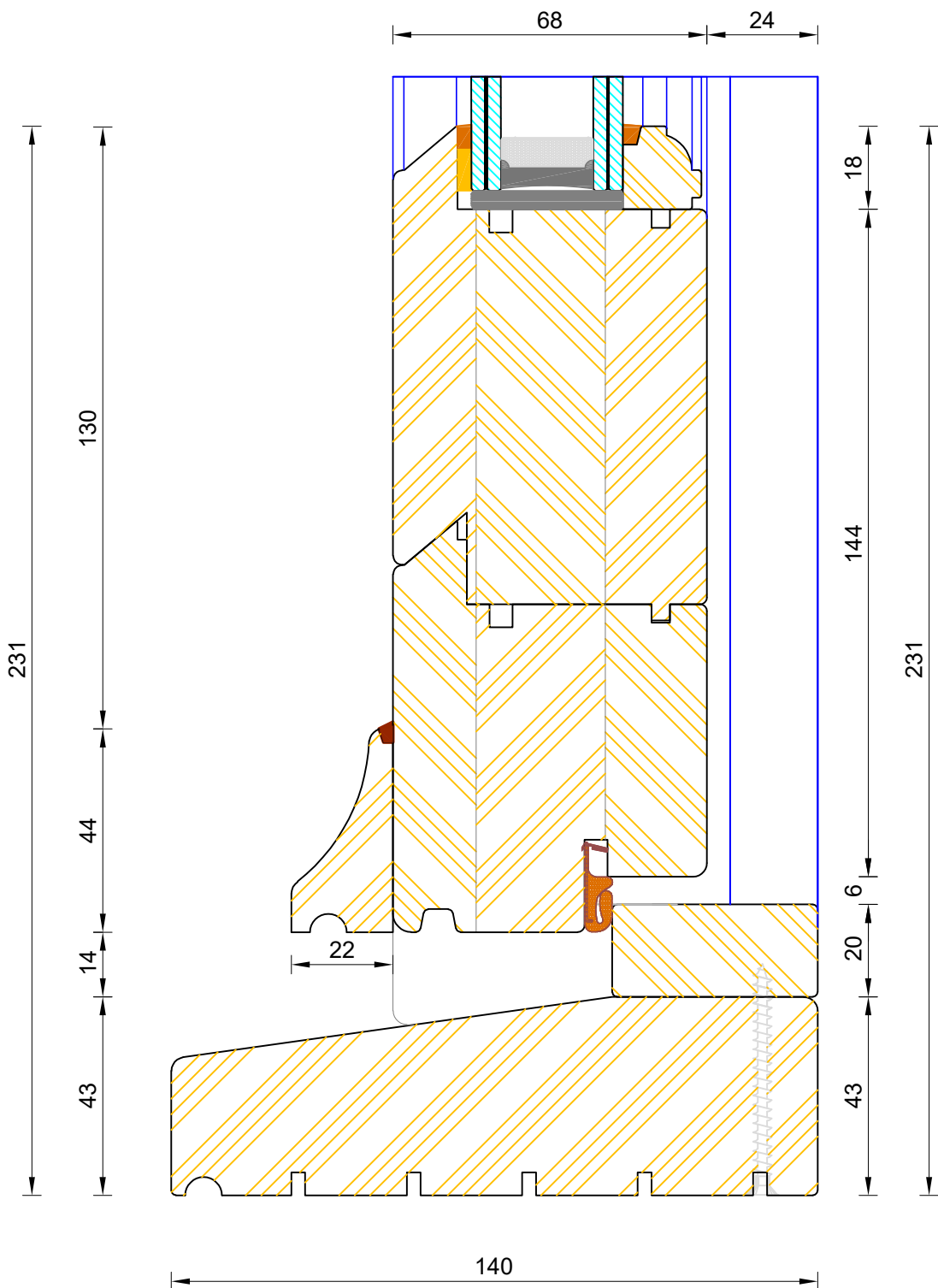

If not otherwise stated, Hardwood Threshold will be stained 5064 Walnut.



**Traditional Open Out Flush Entrance Door
Standard Thresh (140x43mm)**

DIMENSIONS	PLOT SIZE	SCALE	DATE	REV	DWG NO.
MM	A3	1:1	10.08.2022	A	2413

Please consider the environment before printing

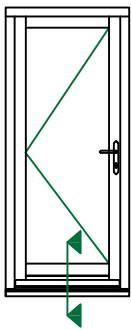
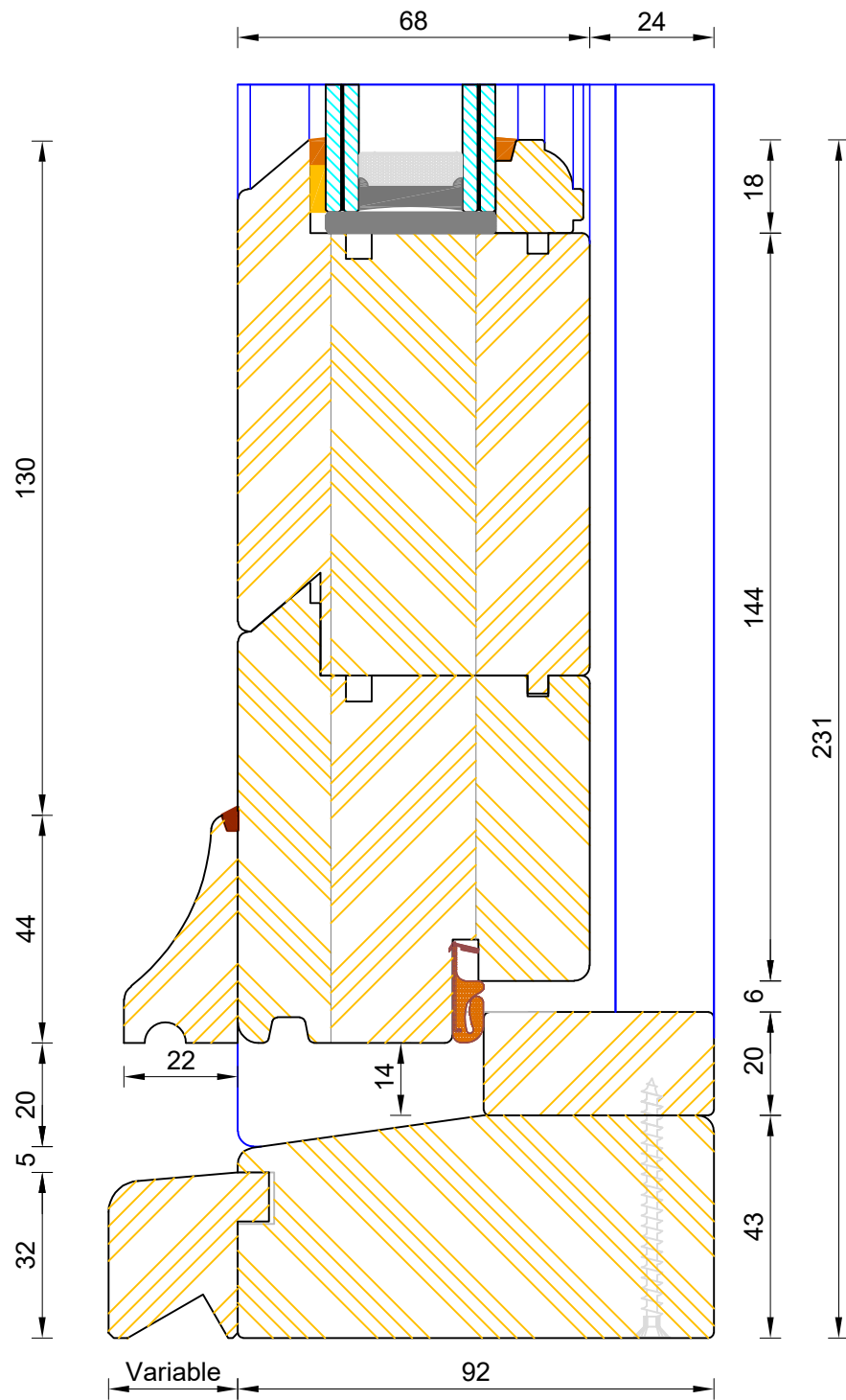

CILL EXTENSION - available options: 25mm (117mm o/a) / 47mm (139mm o/a) / 62mm (154mm o/a) / 87mm (179mm o/a) / 114mm (206mm o/a) / 125mm (217mm o/a) / 140mm (232mm o/a)

NOTE: Cill Extensions should be supported from underneath; the maximum overhang over Brick / Blockwork for cill extension should not exceed 25mm in order to avoid damage when stepped on. Warranties are invalidated when fitted with overhang in excess to that.

If not otherwise stated, Hardwood Threshold will be painted the same colour as Frame.



Traditional Open Out Flush Entrance Door Coupling Thresh

DIMENSIONS	PLOT SIZE	SCALE	DATE	REV	DWG NO.
MM	A3	1:1	10.08.2022	A	2414
Please consider the environment before printing					

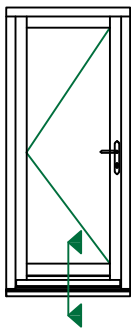
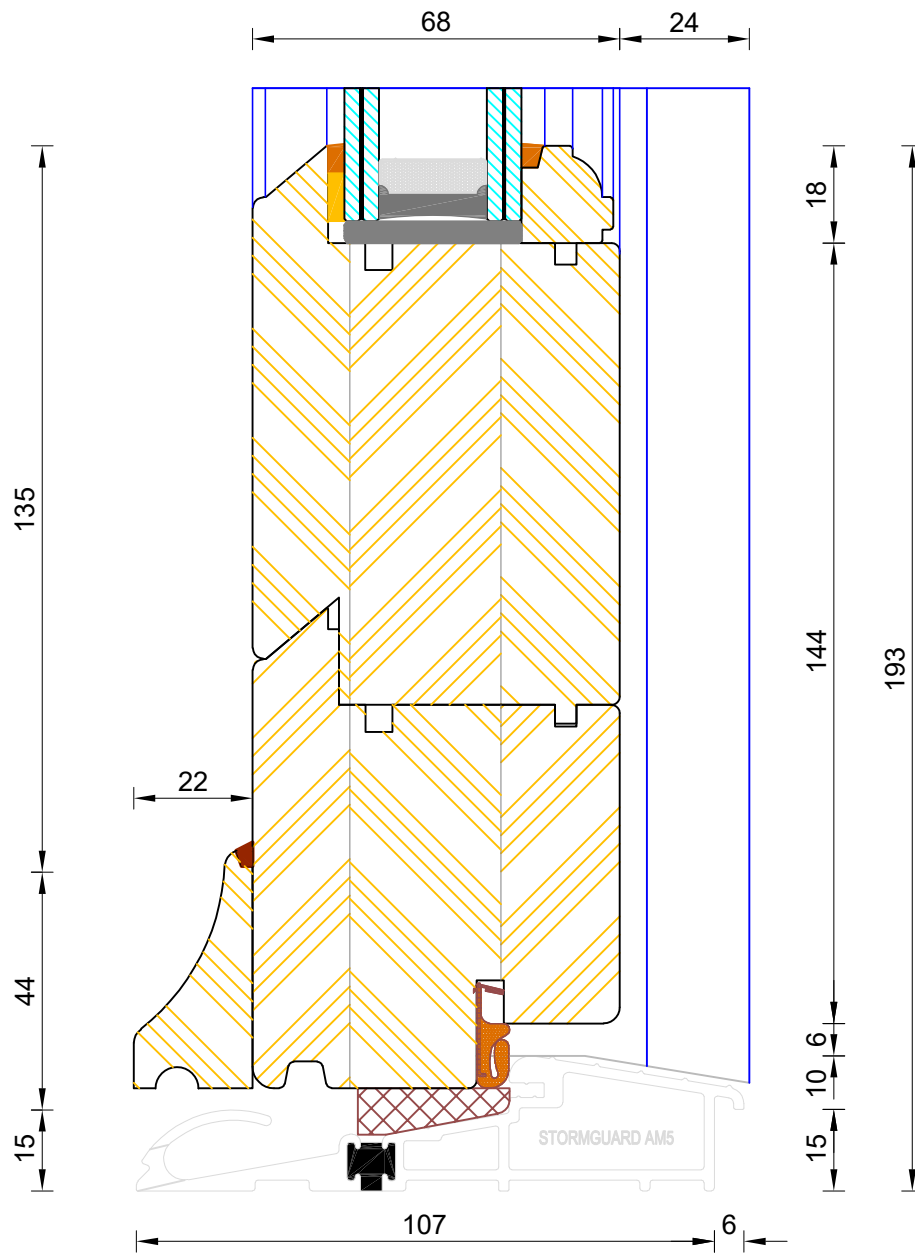

**Traditional Open Out Flush Entrance Door
Mobility Threshold**

DIMENSIONS	PLOT SIZE	SCALE	DATE	REV	DWG NO.
MM	A3	1:1	10.08.2022	A	2415
Please consider the environment before printing					

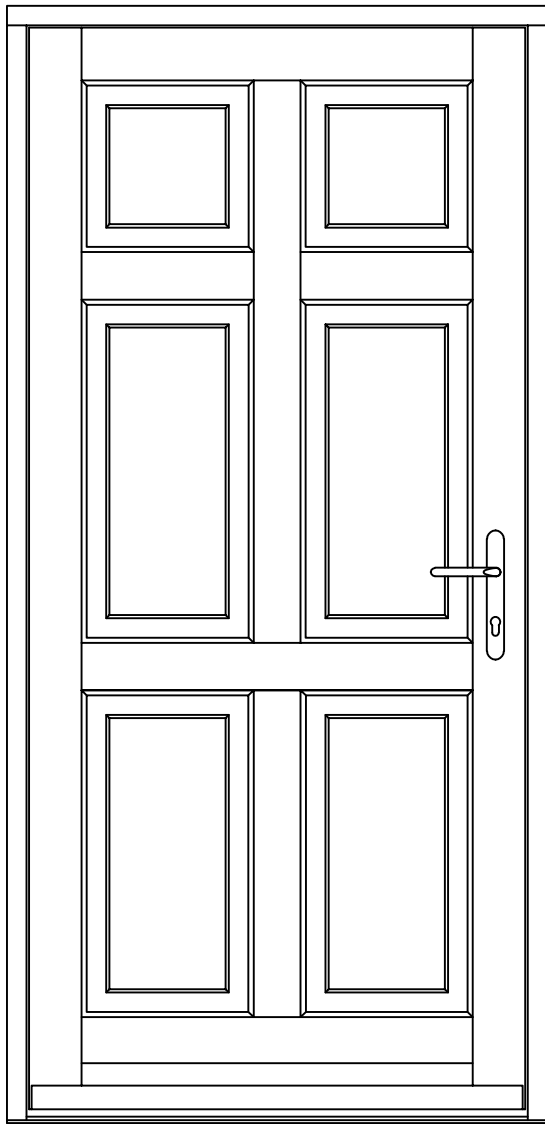

OUTSIDE

INSIDE

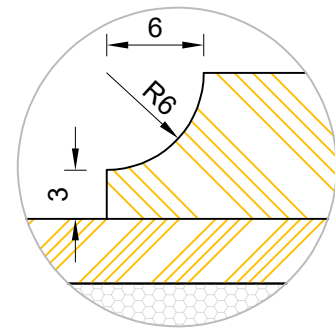
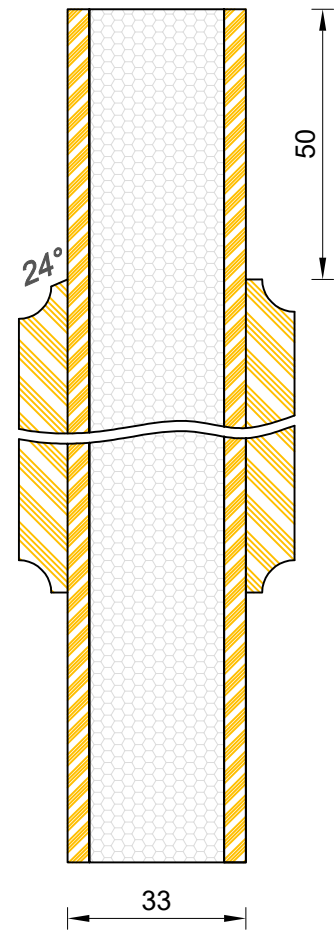

OUTSIDE

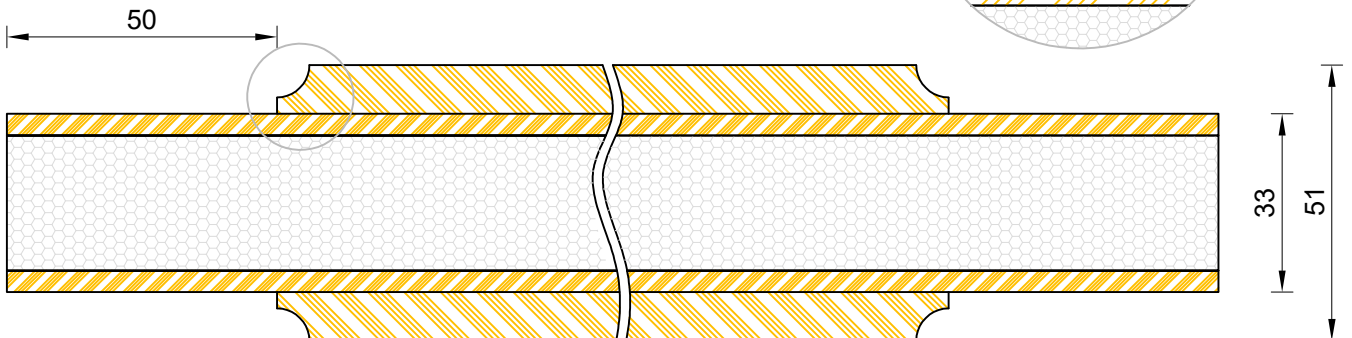

INSIDE



Traditional Open Out Flush Entrance Door
Standard Raised and Fielded Panel (RFA wo 33)

DIMENSIONS	PLOT SIZE	SCALE	DATE	REV	DWG NO.
MM	A3	1:1	21.05.2019	A	2421.1

Please consider the environment before printing

BP wo 33 without letter plate/ BP I wo 33 with letter plate

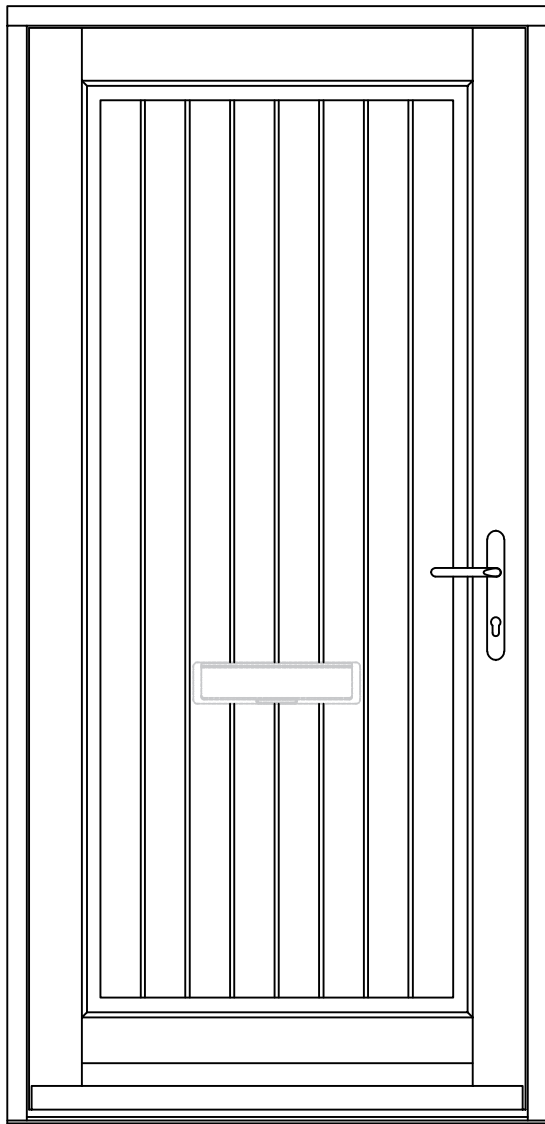

OUTSIDE

INSIDE

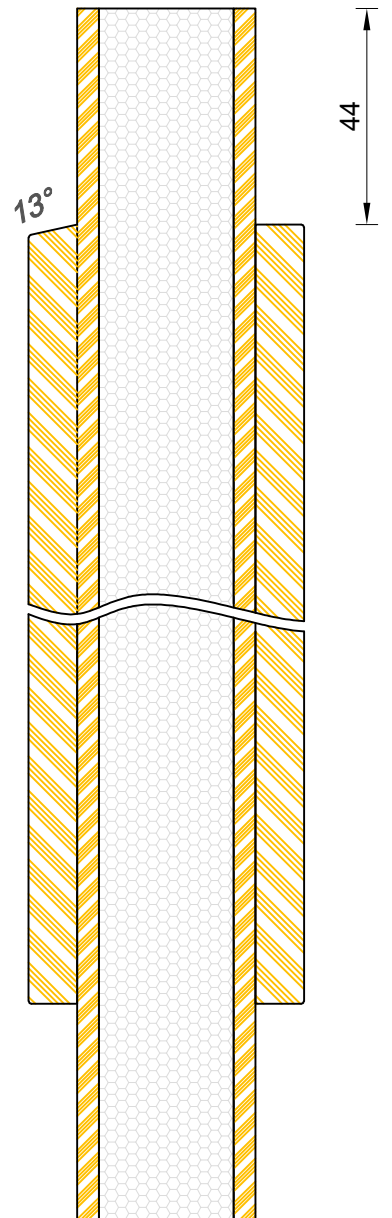

H = 9mm on painted finishes (51mm o/a)
 H = 7mm on stained finishes (47mm o/a)
 W = varies depending on door leaf width

OUTSIDE

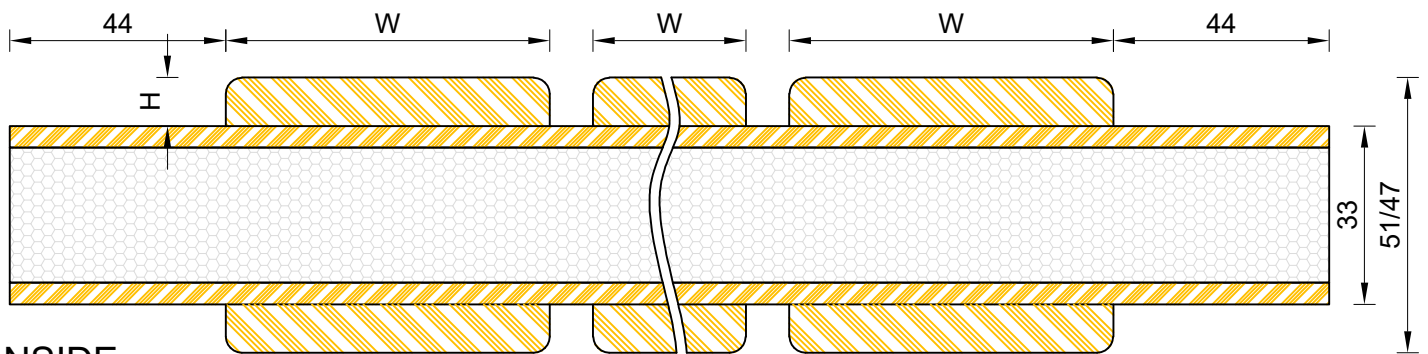

INSIDE



Traditional Open Out Flush Entrance Door
 Standard Boarded Panel

DIMENSIONS	PLOT SIZE	SCALE	DATE	REV	DWG NO.
MM	A3	1:1	21.05.2019	A	2421.2

Please consider the environment before printing

BP g wo 33 without letter plate/ BP gl wo 33 with letter plate

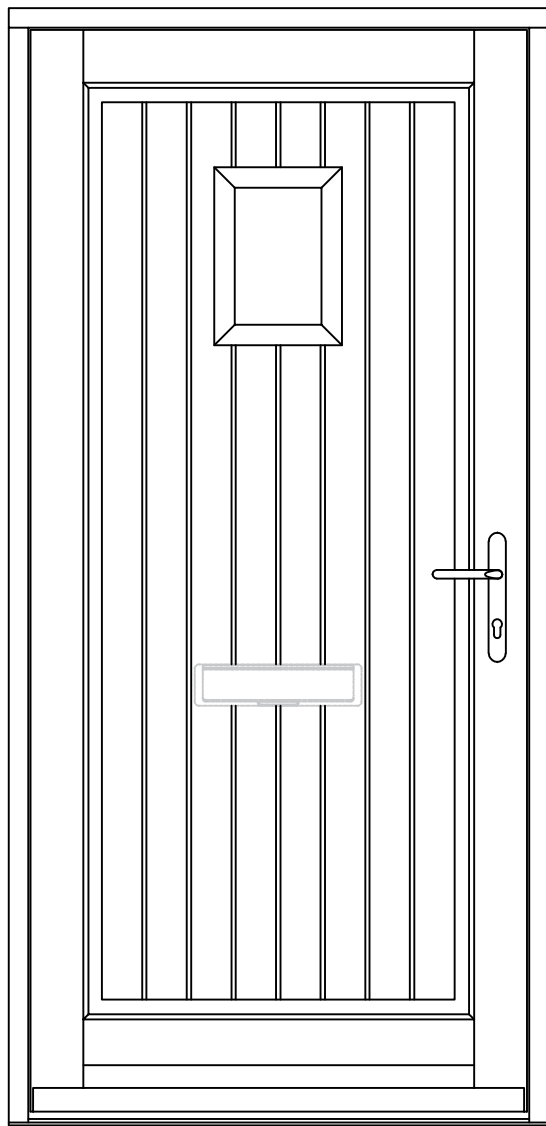

OUTSIDE

INSIDE

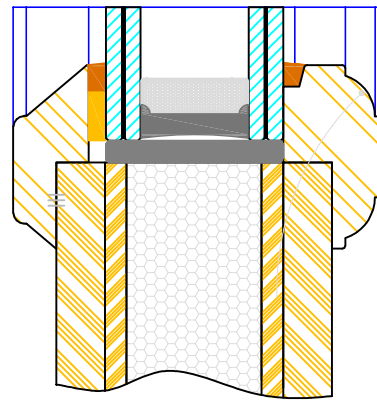

51

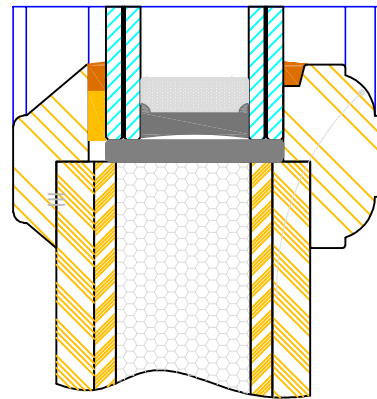

47

13°

44

H = 9mm on painted finishes (51mm o/a)

H = 7mm on stained finishes (47mm o/a)

W = varies depending on door leaf width

OUTSIDE

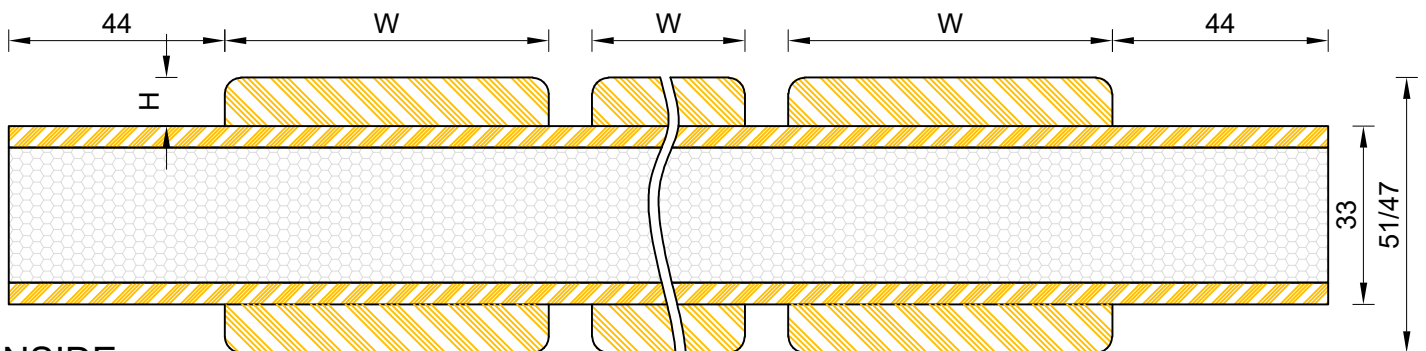

INSIDE



Traditional Open Out Flush Entrance Door
Standard Boarded Panel with Glass

DIMENSIONS	PLOT SIZE	SCALE	DATE	REV	DWG NO.
MM	A3	1:1	21.05.2019	A	2421.3

Please consider the environment before printing