

Traditional Open Out Flush Entrance Door
Triple Glazed - Cill Extension Options

DIMENSIONS	PLOT SIZE	SCALE	DATE	REV	DWG NO.
MM	A4	1:1	25.09.2019	B	2451
Please consider the environment before printing					

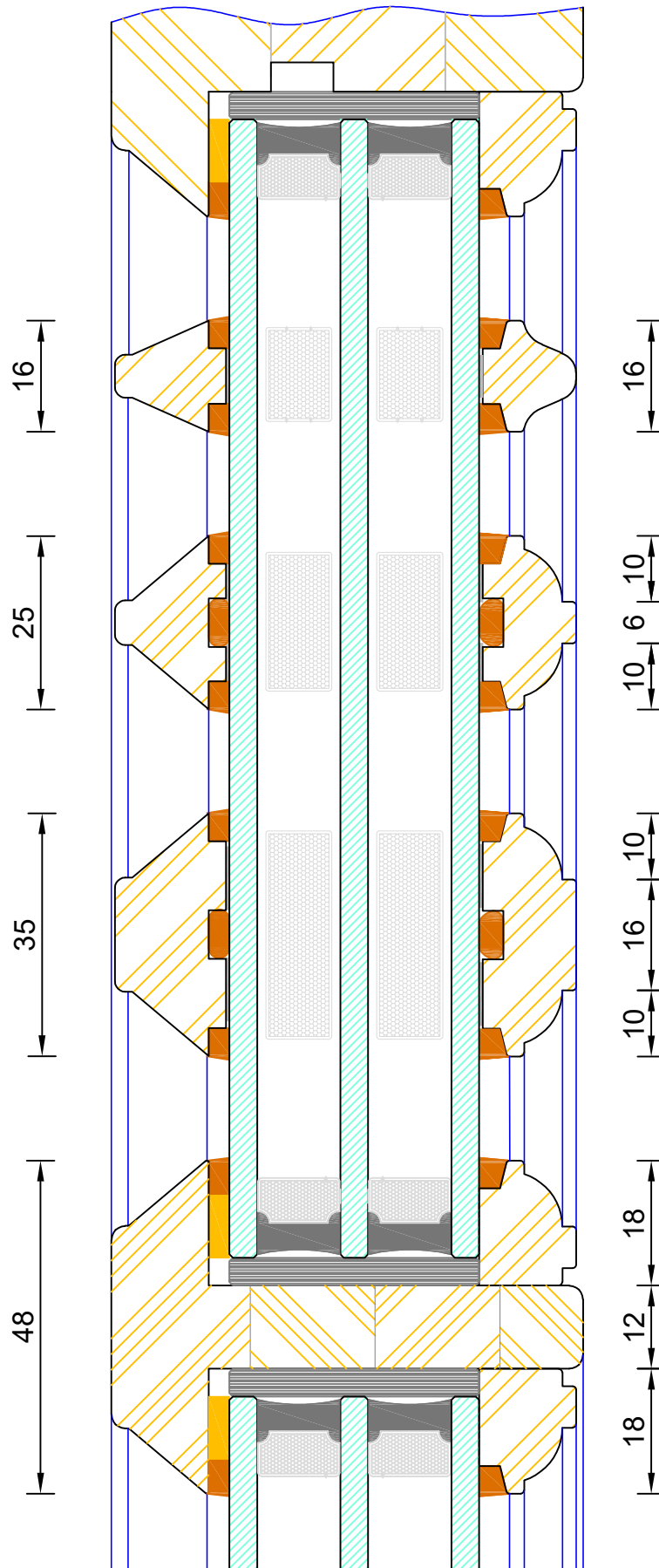

Traditional Open Out Flush Entrance Door
Triple Glazed - Bar Options

DIMENSIONS	PLOT SIZE	SCALE	DATE	REV	DWG NO.
MM	A4	1:1	01.01.2019	B	2452
Please consider the environment before printing					

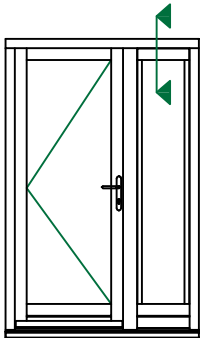
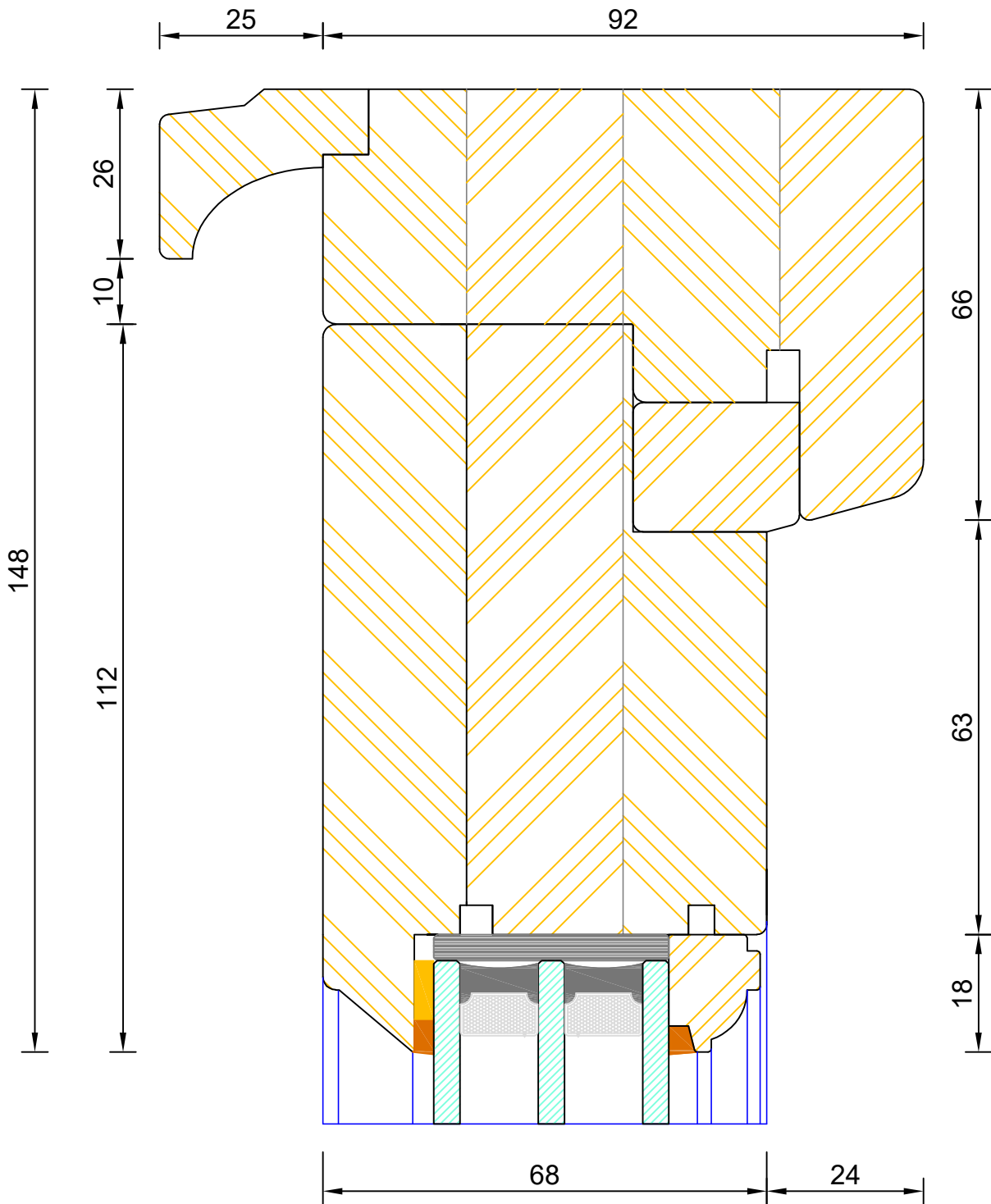

DIMENSIONS	PLOT SIZE	SCALE	DATE	REV	DWG NO.
MM	A4	1:1	10.08.2022	A	2453
Please consider the environment before printing					

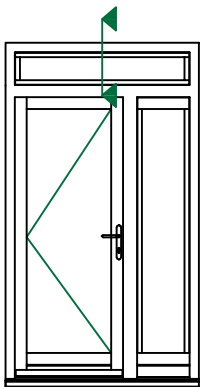
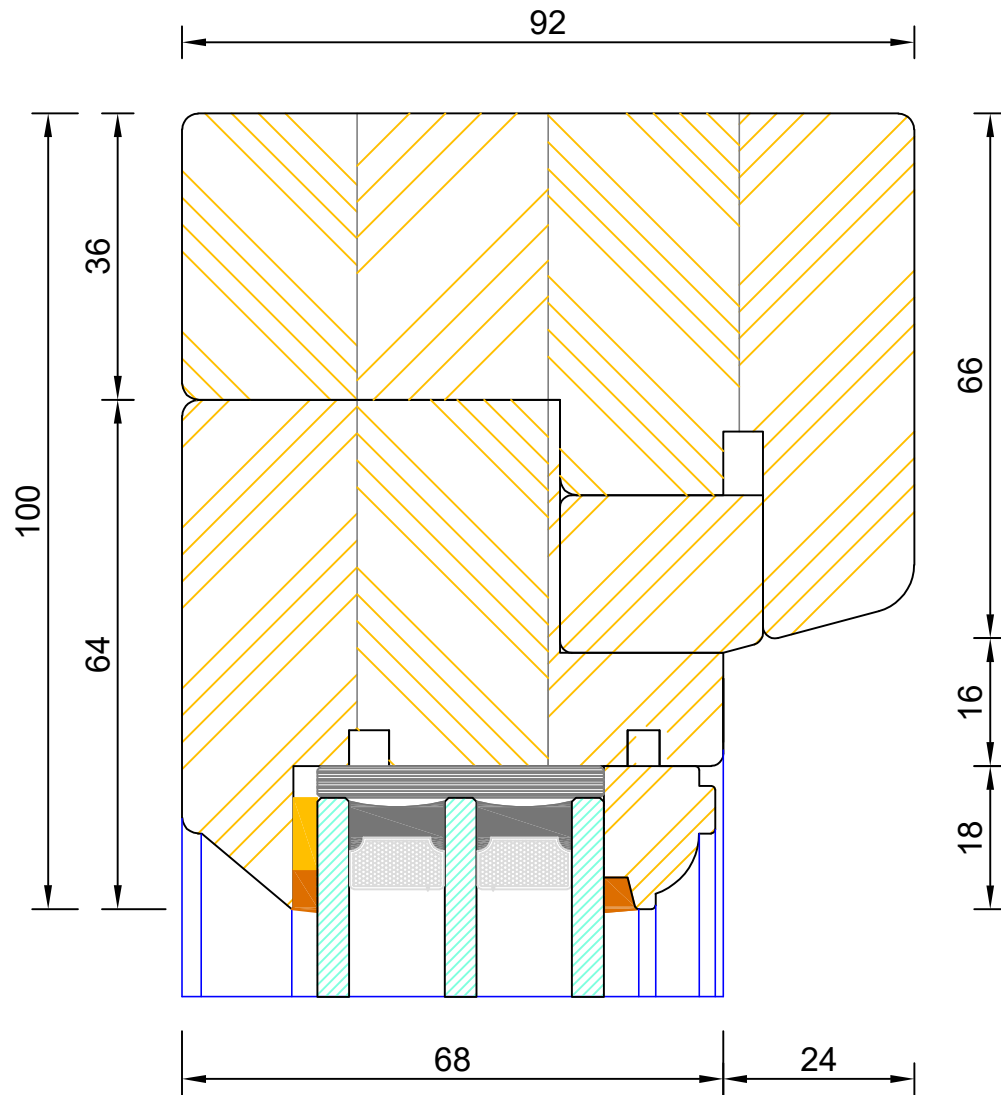

**Traditional Open Out Flush Entrance Door
Triple Glazed - Fanlight Head**

DIMENSIONS	PLOT SIZE	SCALE	DATE	REV	DWG NO.
MM	A4	1:1	10.08.2022	A	2454
Please consider the environment before printing					

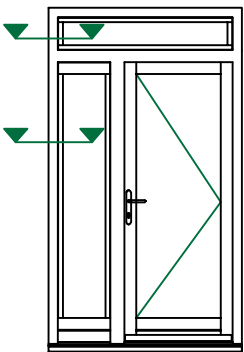
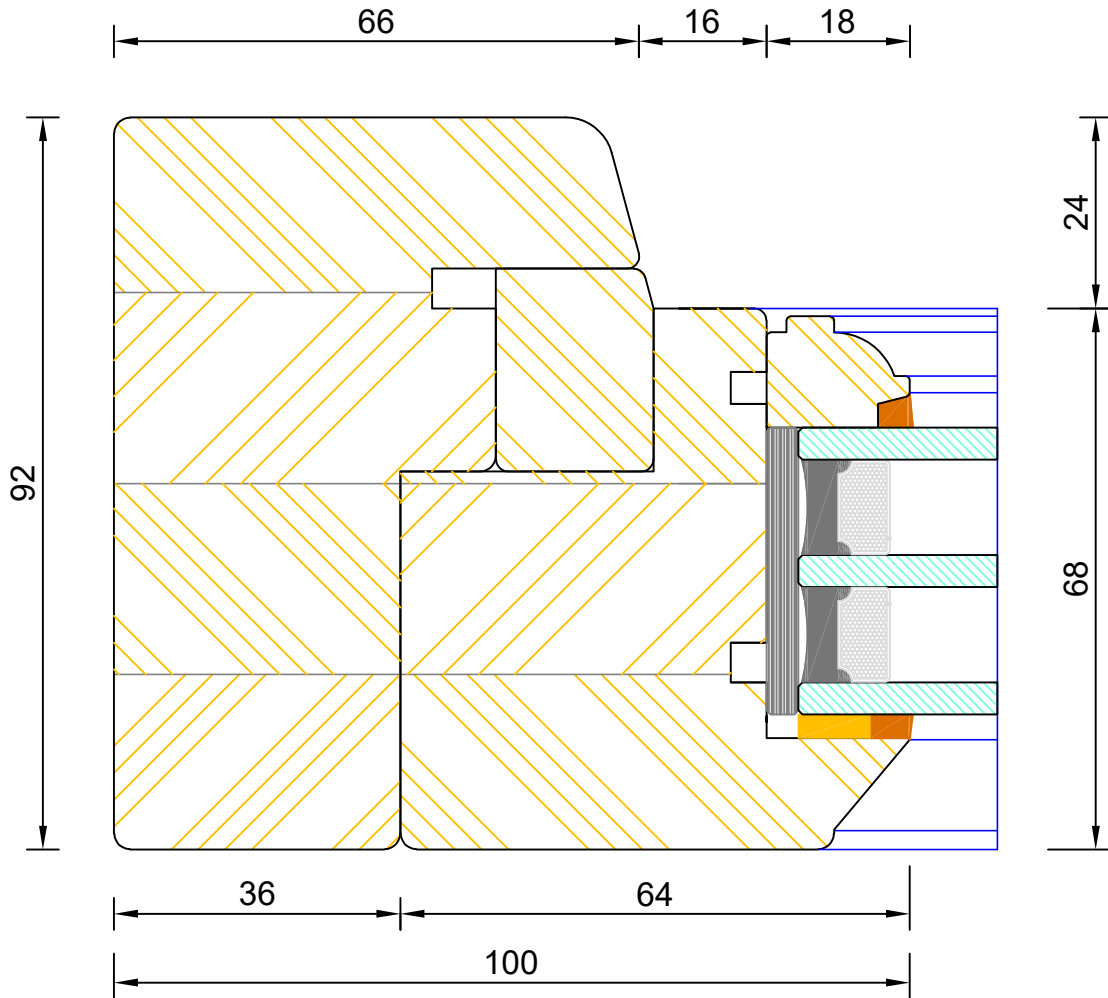

Traditional Open Out Flush Entrance Door
Triple Glazed - Sidelight / Fanlight Jamb

DIMENSIONS	PLOT SIZE	SCALE	DATE	REV	DWG NO.
MM	A4	1:1	10.08.2022	A	2455

Please consider the environment before printing

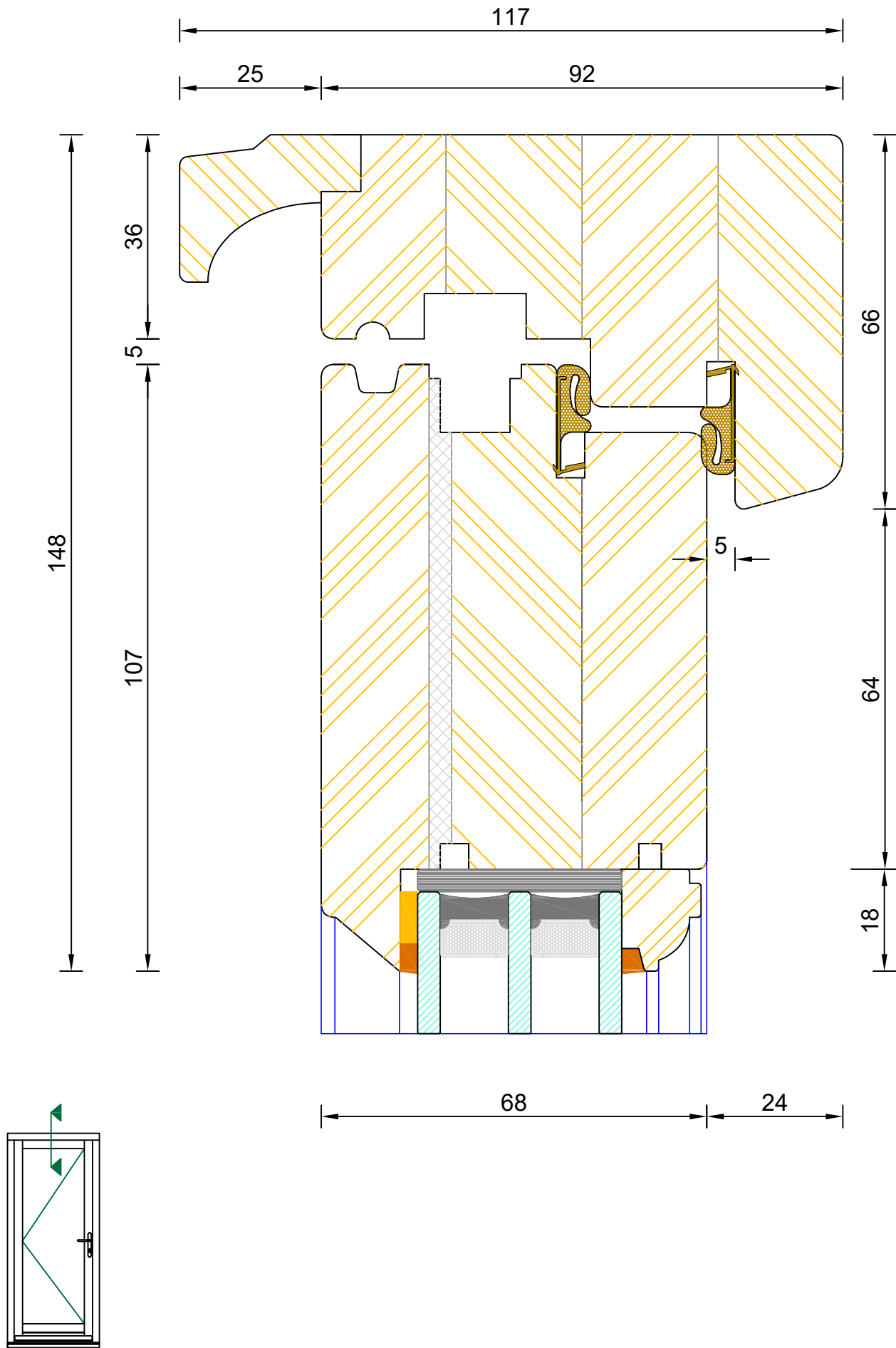

Traditional Open Out Flush Entrance Door Triple Glazed - Frame & Leaf Head

DIMENSIONS	PLOT SIZE	SCALE	DATE	REV	DWG NO.
MM	A4	1:1	10.08.2022	A	2459
Please consider the environment before printing					

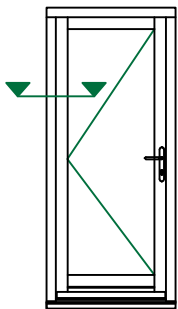
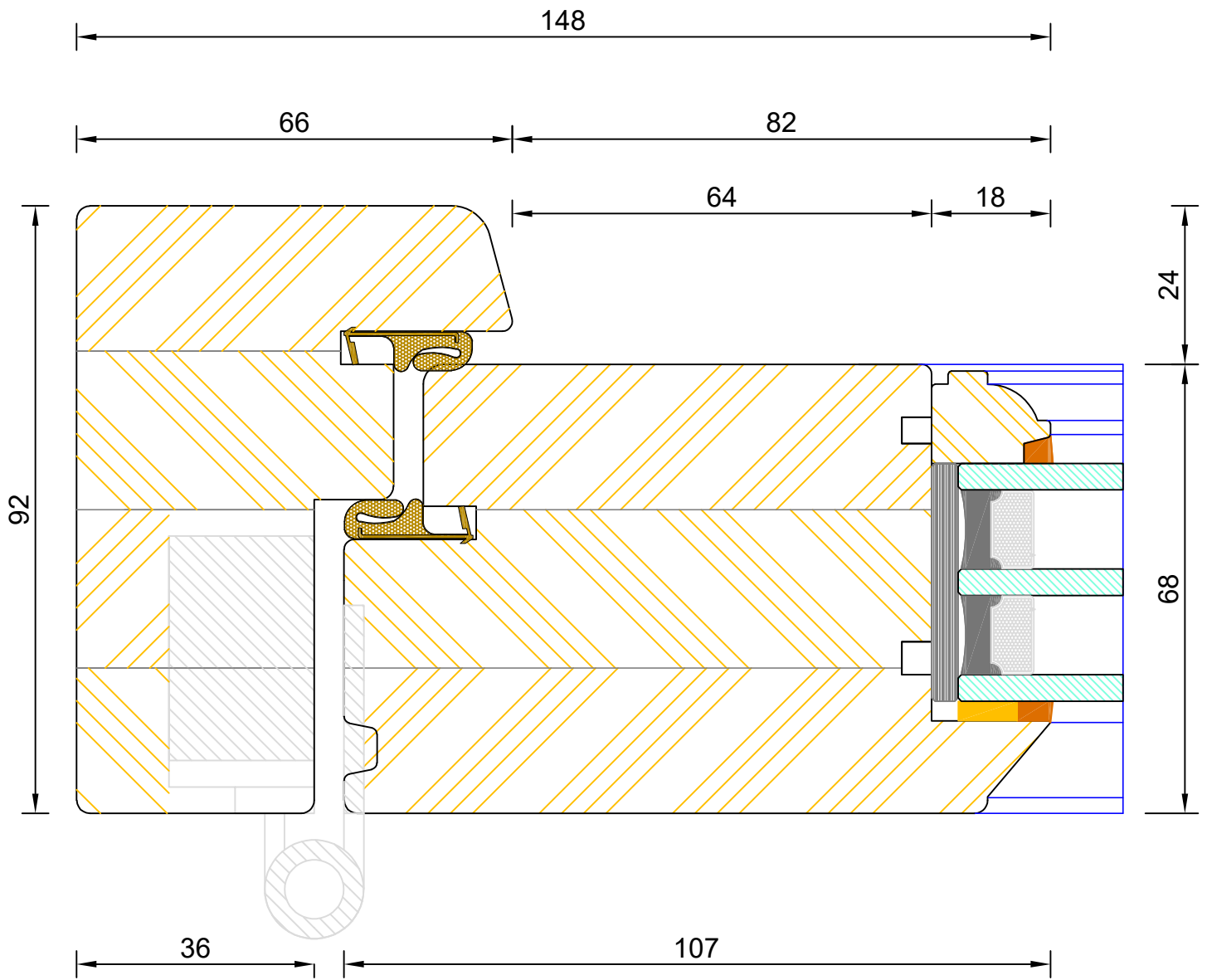

Traditional Open Out Flush Entrance Door
Triple Glazed - Frame & Leaf Jamb (Hinge Side)

DIMENSIONS	PLOT SIZE	SCALE	DATE	REV	DWG NO.
MM	A4	1:1	10.08.2022	A	2460
Please consider the environment before printing					

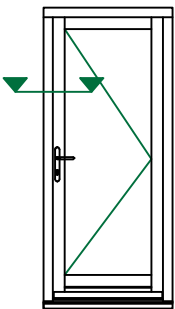
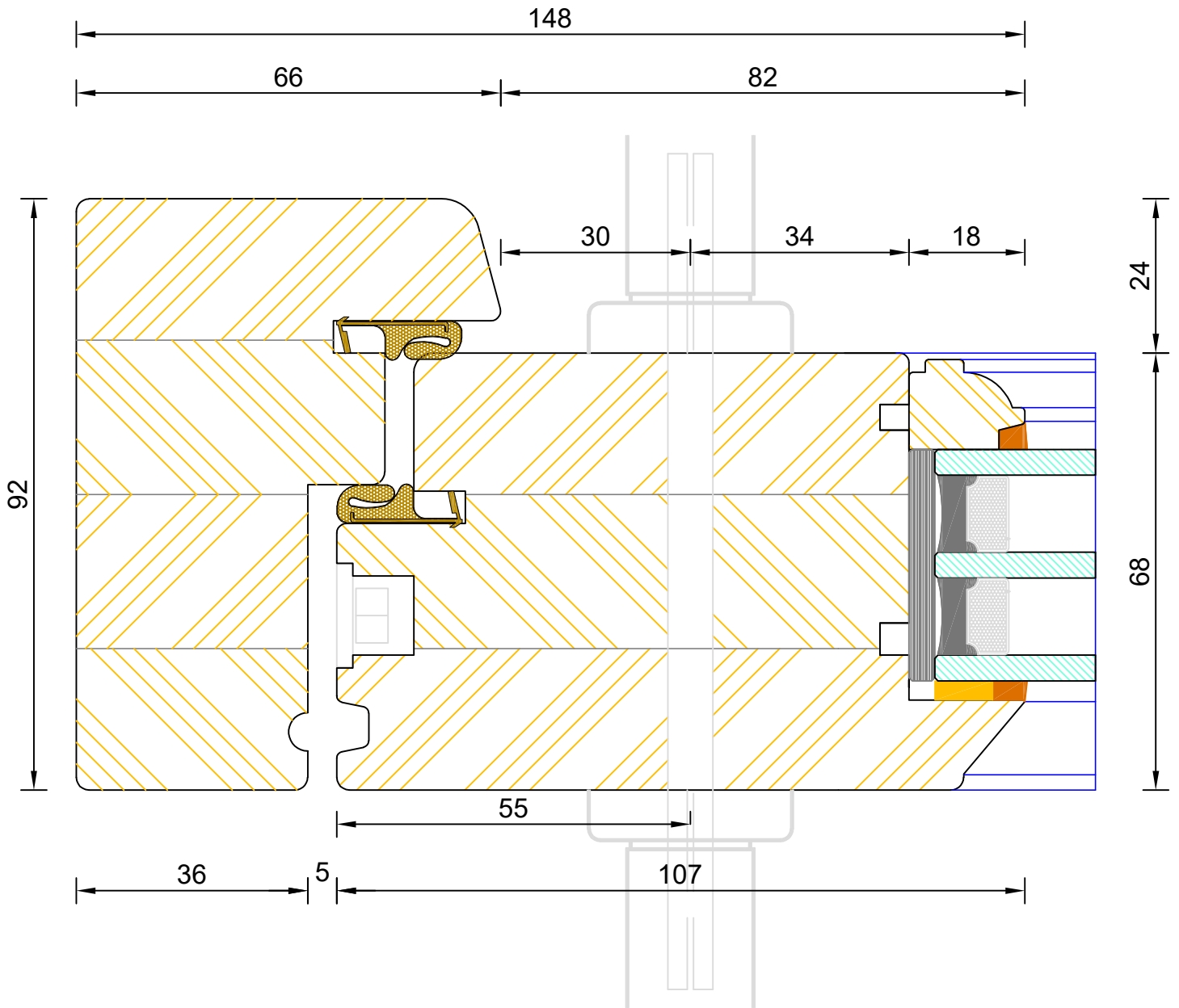

Traditional Open Out Flush Entrance Door
Triple Glazed - Frame & Leaf Jamb (Handle Side)

DIMENSIONS	PLOT SIZE	SCALE	DATE	REV	DWG NO.
MM	A4	1:1	10.08.2022	A	2461
Please consider the environment before printing					

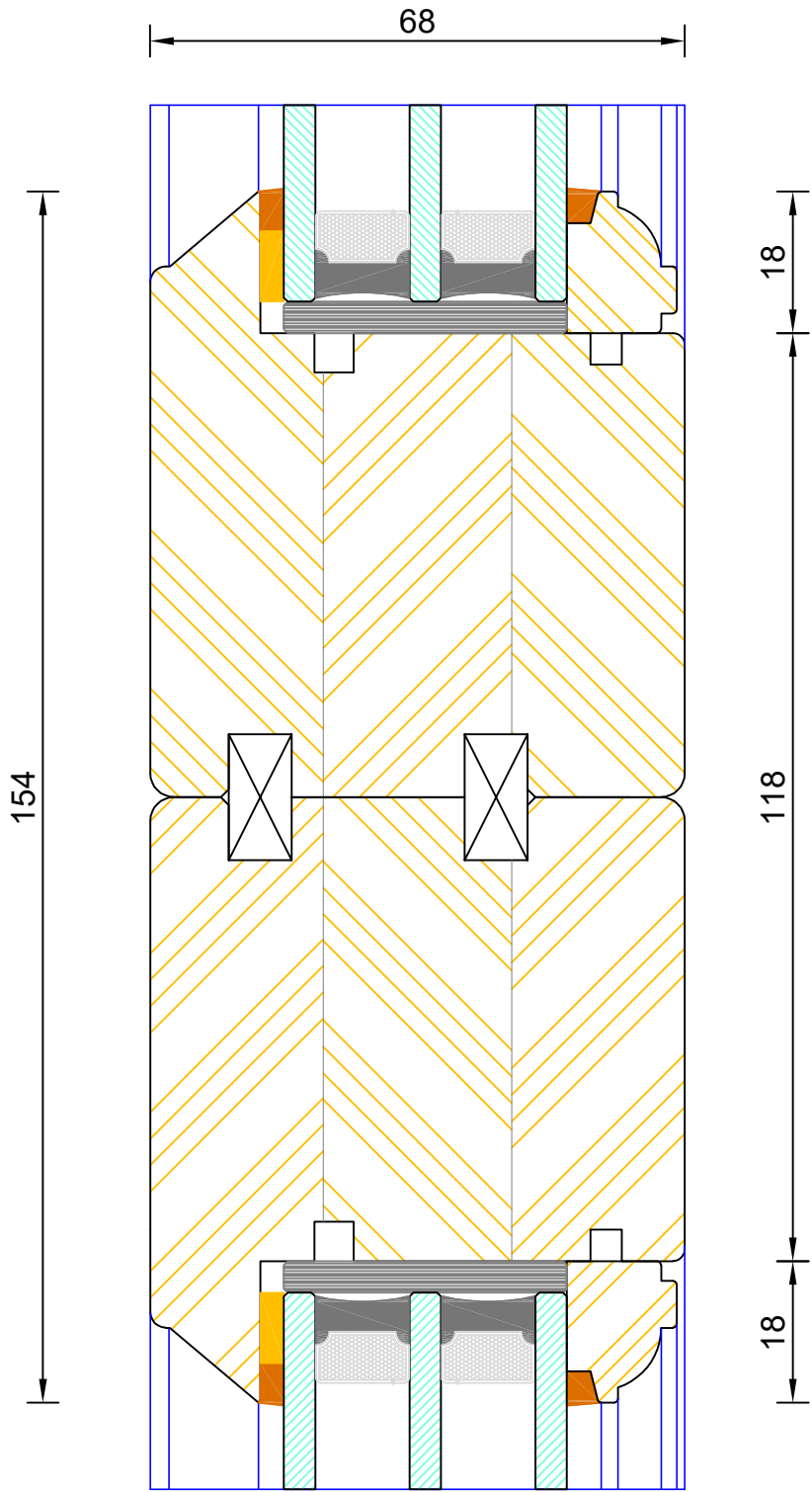
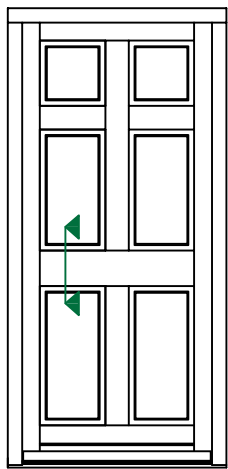

Traditional Open Out Flush Entrance Door
 Triple Glazed - Mid Rail (Optional 154mm)

DIMENSIONS	PLOT SIZE	SCALE	DATE	REV	DWG NO.
MM	A4	1:1	10.08.2022	A	2466
Please consider the environment before printing					

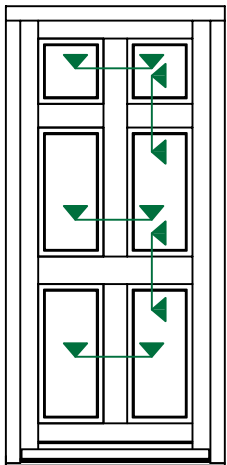
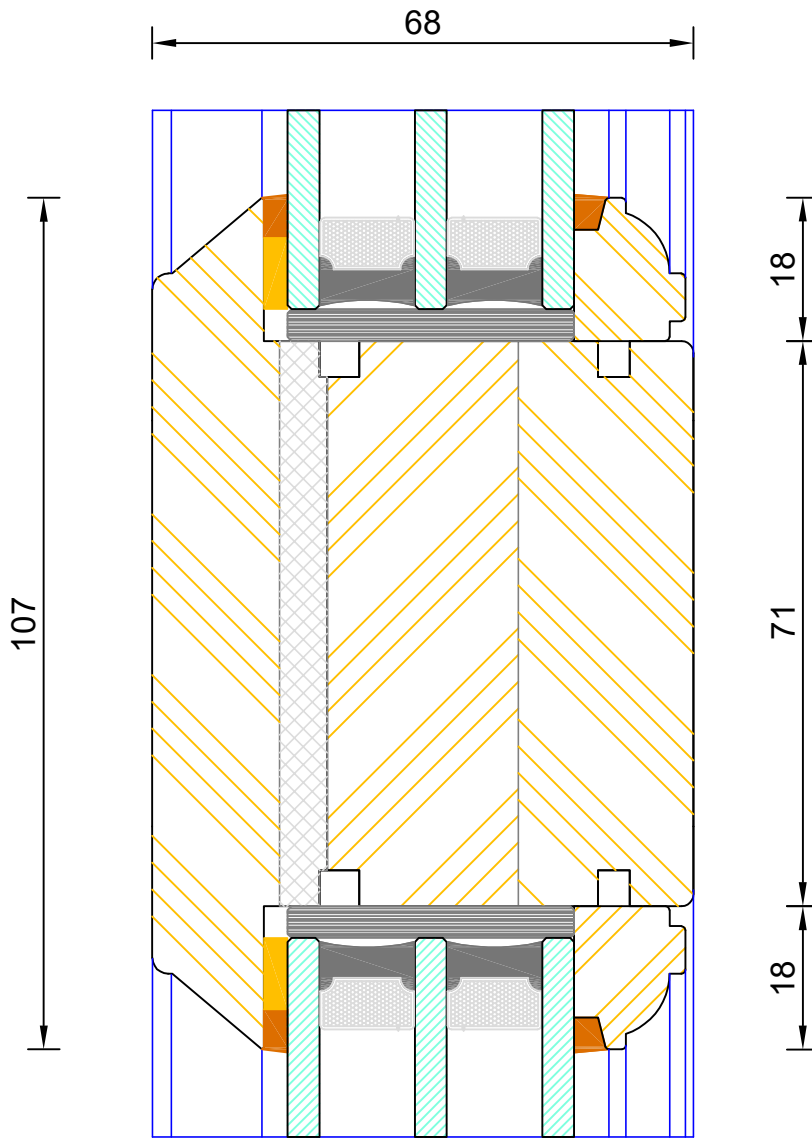

Traditional Open Out Flush Entrance Door
Triple Glazed - Mid Rail (107mm)

DIMENSIONS	PLOT SIZE	SCALE	DATE	REV	DWG NO.
MM	A4	1:1	10.08.2022	A	2467
Please consider the environment before printing					

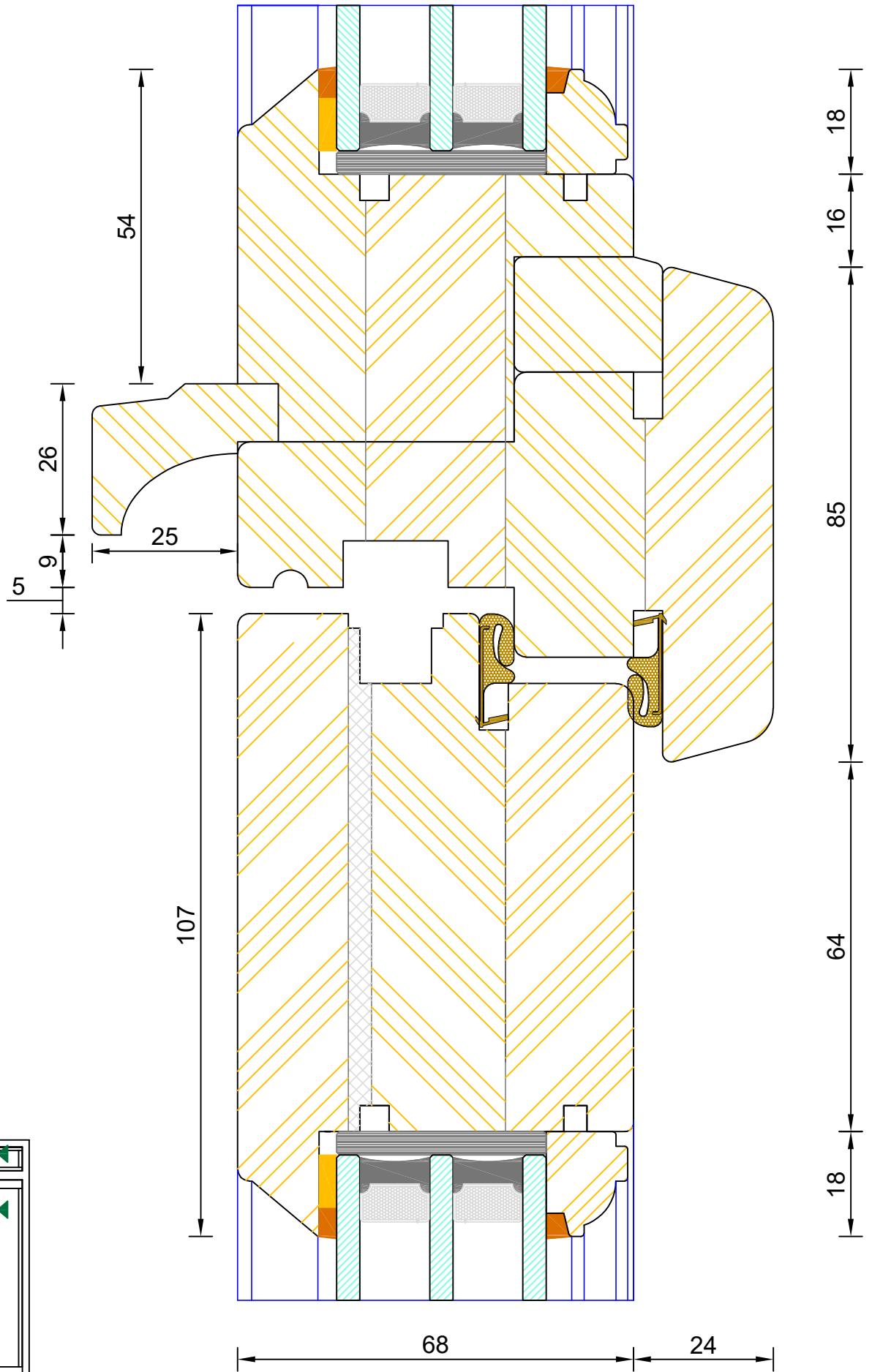
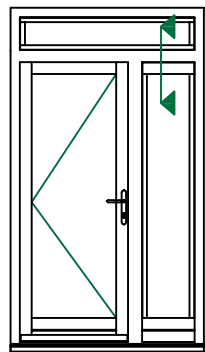

Traditional Open Out Flush Entrance Door
 Triple Glazed - Solid Transom (Fanlight / Door Leaf)

DIMENSIONS	PLOT SIZE	SCALE	DATE	REV	DWG NO.
MM	A4	1:1	10.08.2022	A	2462
Please consider the environment before printing					

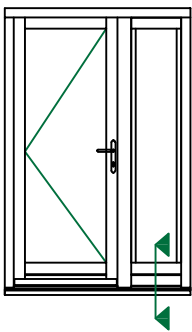
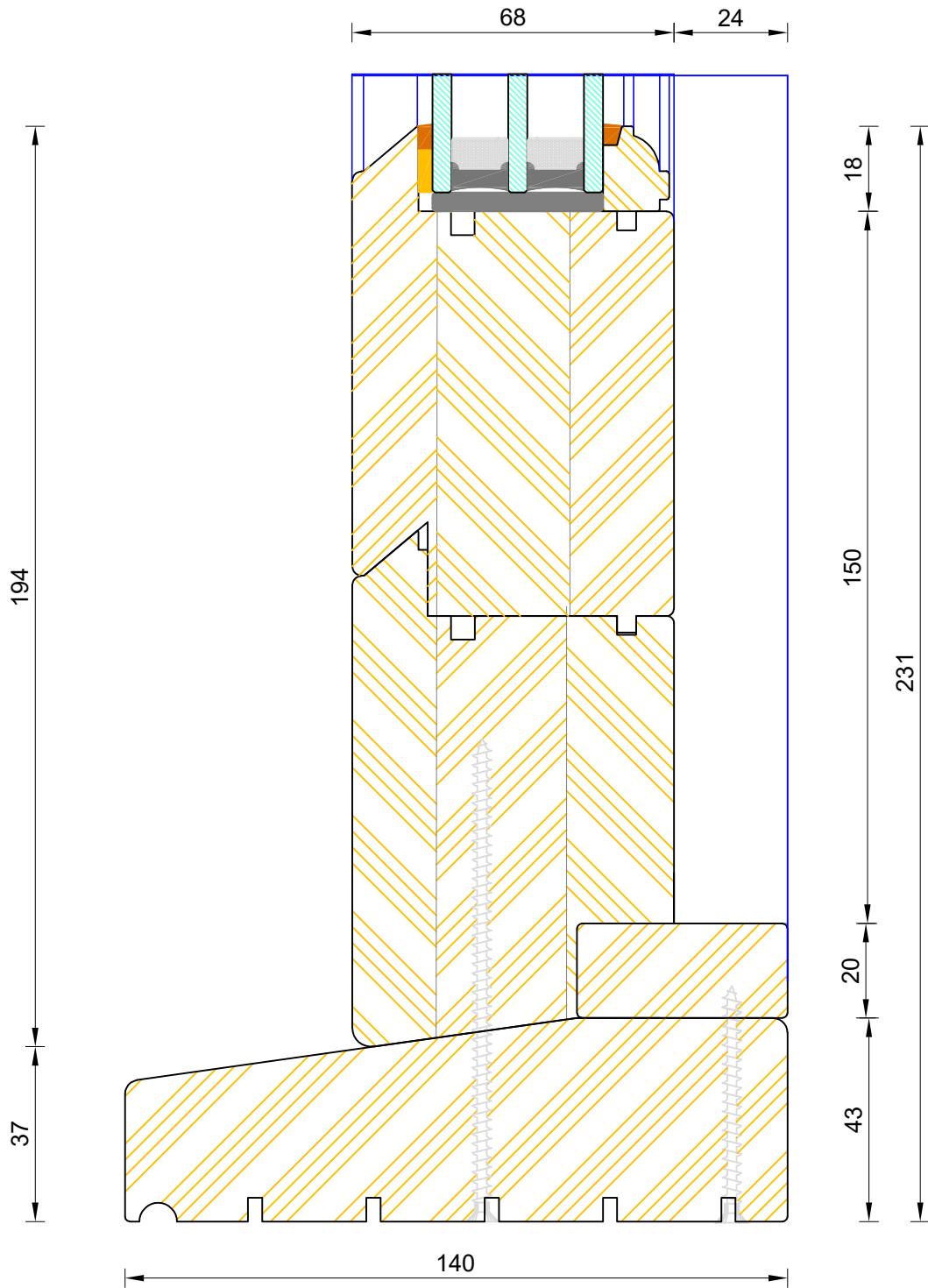

If not otherwise stated, Hardwood Threshold will be stained 5064 Walnut.



Traditional Open Out Flush Entrance Door
Triple Glazed - Standard Thresh (Sidelight)

DIMENSIONS	PLOT SIZE	SCALE	DATE	REV	DWG NO.
MM	A3	1:1	10.08.2022	A	2456
Please consider the environment before printing					

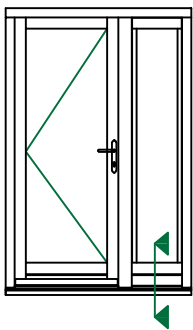
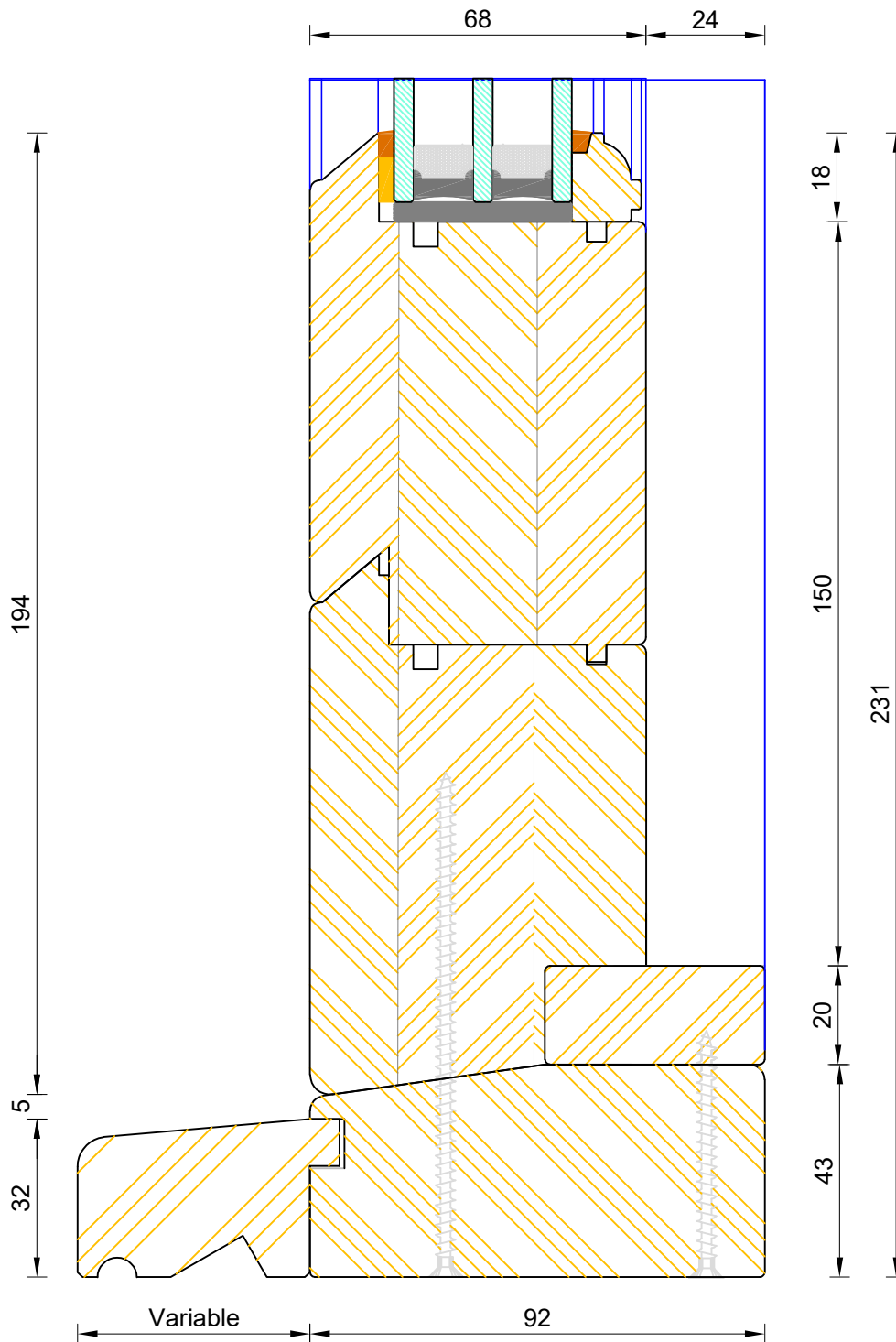

CILL EXTENSION - available options: 25mm (117mm o/a) / 47mm (139mm o/a) / 62mm (154mm o/a) / 87mm (179mm o/a) / 114mm (206mm o/a) / 125mm (217mm o/a) / 140mm (232mm o/a)

NOTE: Cill Extensions should be supported from underneath; the maximum overhang over Brick / Blockwork for cill extension should not exceed 25mm in order to avoid damage when stepped on. Warranties are invalidated when fitted with overhang in excess to that.

If not otherwise stated, Hardwood Threshold will be painted the same colour as Frame.



Traditional Open Out Flush Entrance Door
Triple Glazed - Coupling Thresh (Sidelight)

DIMENSIONS	PLOT SIZE	SCALE	DATE	REV	DWG NO.
MM	A3	1:1	10.08.2022	A	2457

Please consider the environment before printing

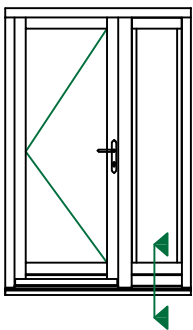
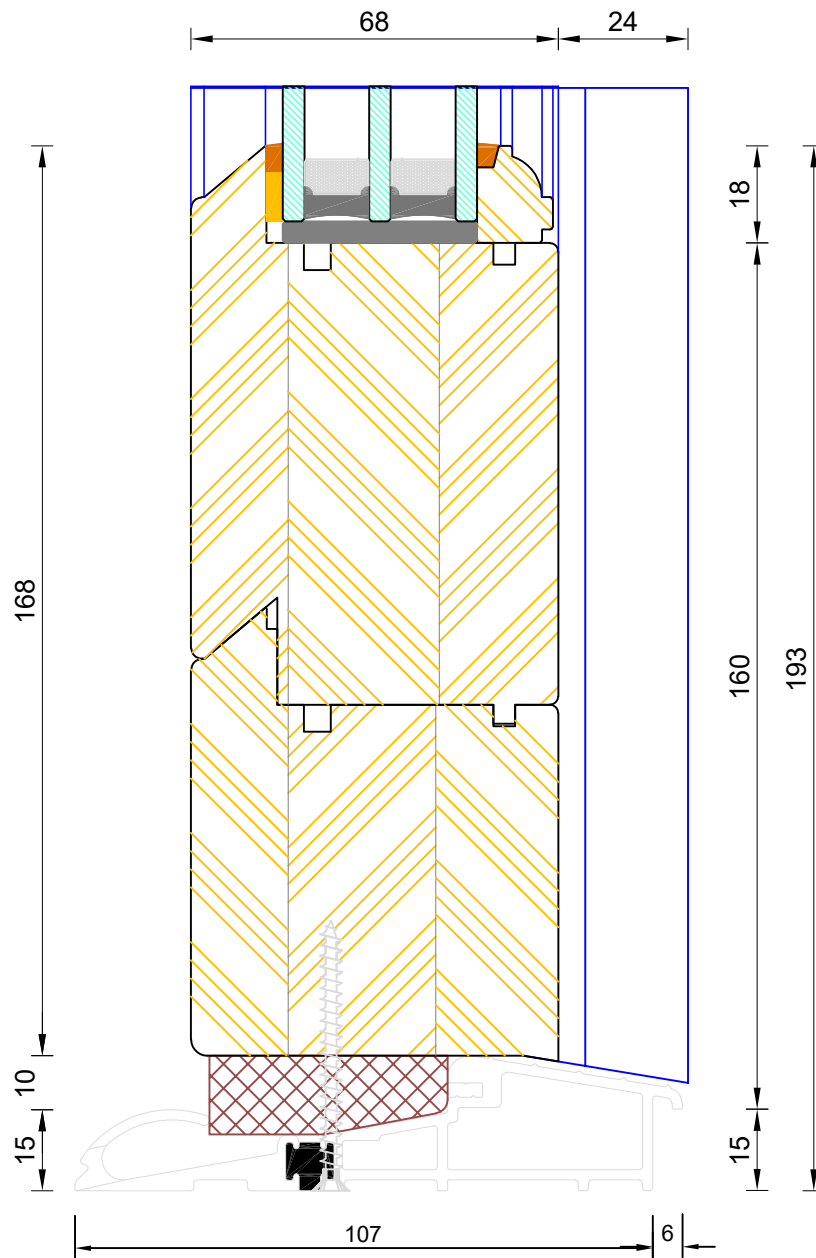

Traditional Open Out Flush Entrance Door
Triple Glazed - Mobility Thresh (Sidelight)

DIMENSIONS	PLOT SIZE	SCALE	DATE	REV	DWG NO.
MM	A3	1:1	10.08.2022	A	2458
Please consider the environment before printing					

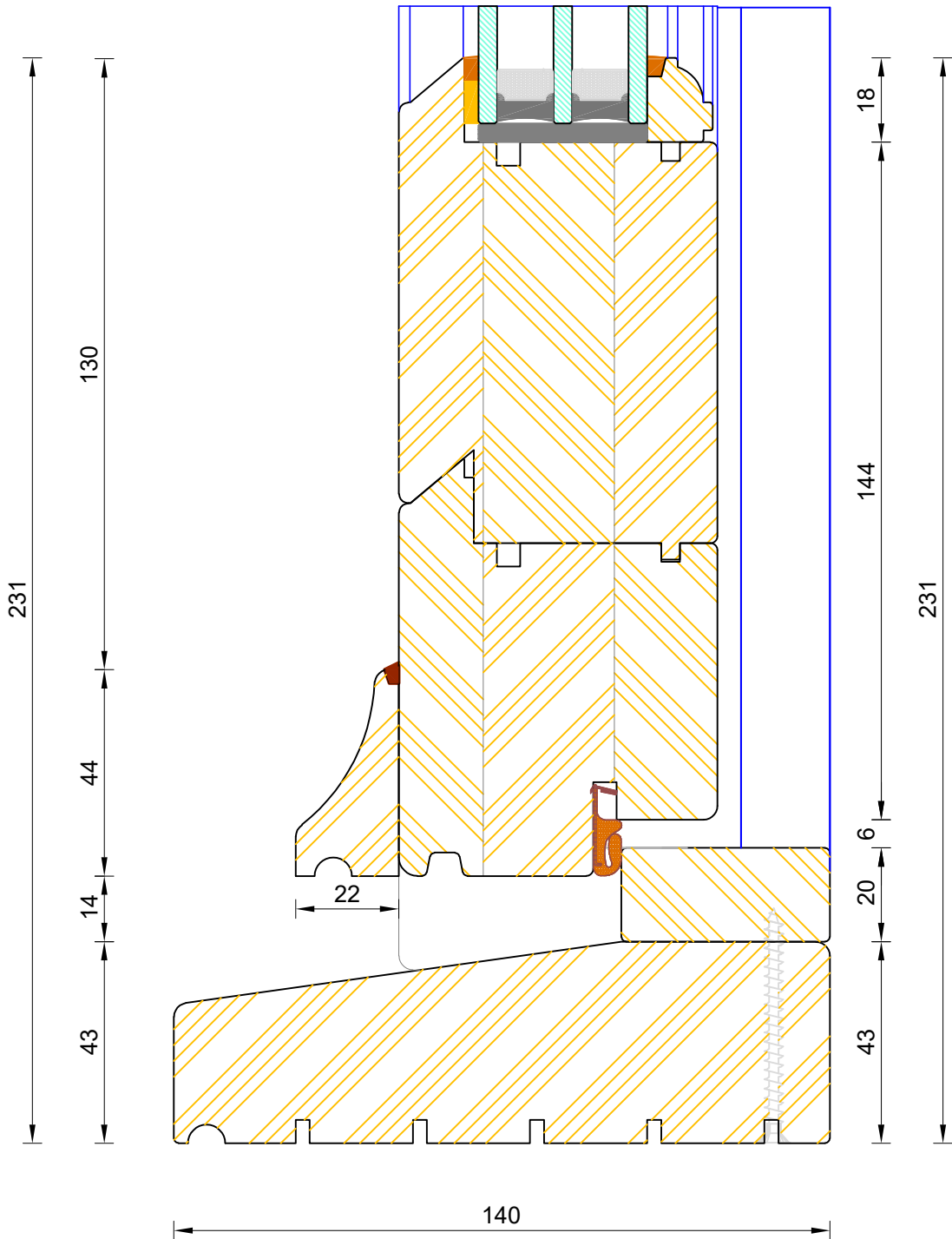
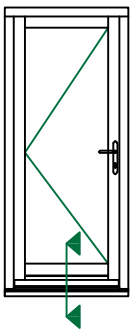

If not otherwise stated, Hardwood Threshold will be stained 5064 Walnut.



Bereco

Traditional Open Out Flush Entrance Door
Triple Glazed - Standard Thresh (140x43mm)

DIMENSIONS	PLOT SIZE	SCALE	DATE	REV	DWG NO.
MM	A3	1:1	10.08.2022	A	2463
Please consider the environment before printing					

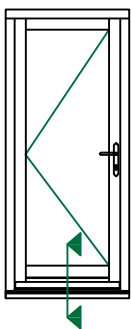
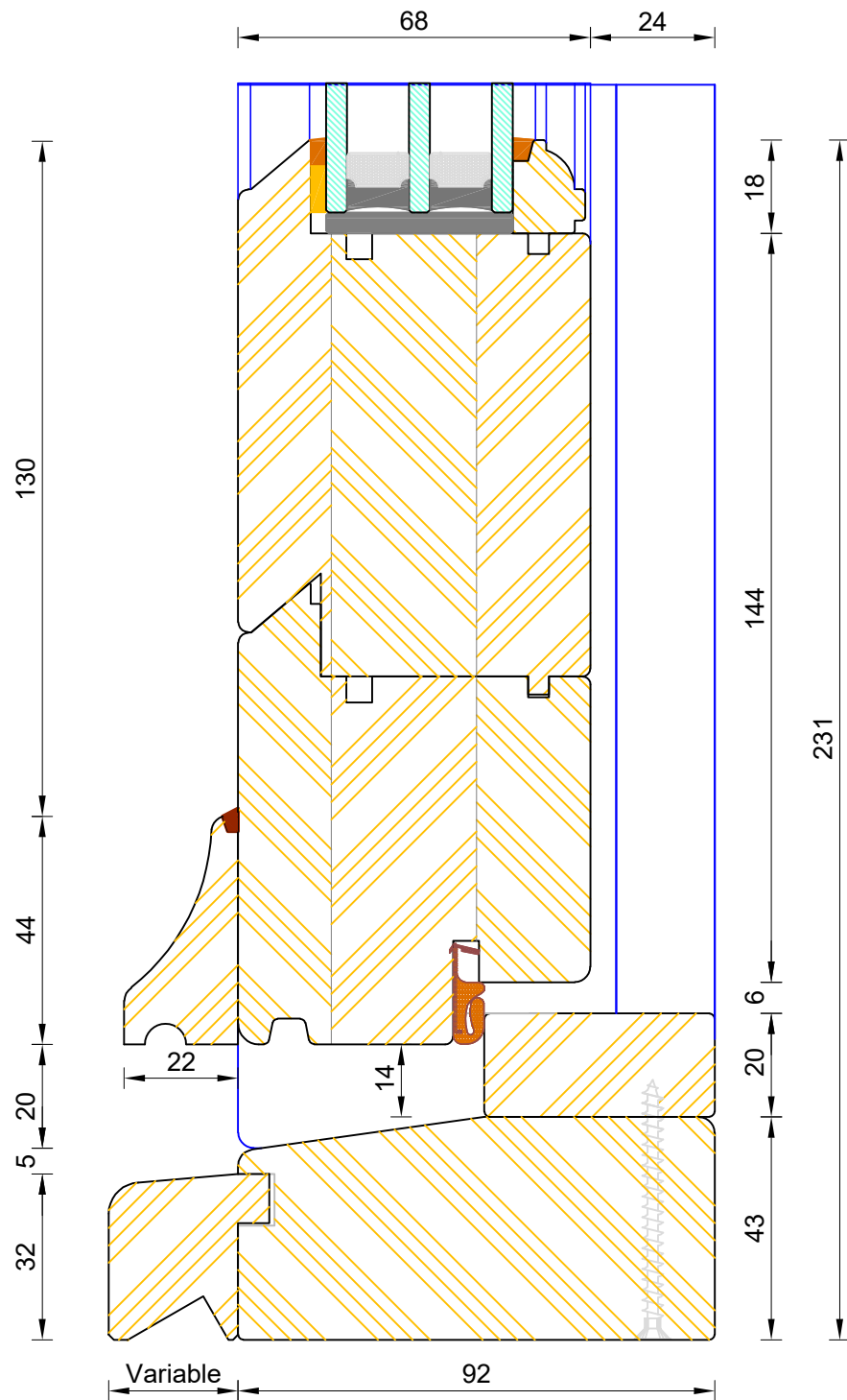

CILL EXTENSION - available options: 25mm (117mm o/a) / 47mm (139mm o/a) / 62mm (154mm o/a) / 87mm (179mm o/a) / 114mm (206mm o/a) / 125mm (217mm o/a) / 140mm (232mm o/a)

NOTE: Cill Extensions should be supported from underneath; the maximum overhang over Brick / Blockwork for cill extension should not exceed 25mm in order to avoid damage when stepped on. Warranties are invalidated when fitted with overhang in excess to that.

If not otherwise stated, Hardwood Threshold will be painted the same colour as Frame.



Traditional Open Out Flush Entrance Door Triple Glazed - Coupling Thresh

DIMENSIONS	PLOT SIZE	SCALE	DATE	REV	DWG NO.
MM	A3	1:1	10.08.2022	A	2464
Please consider the environment before printing					

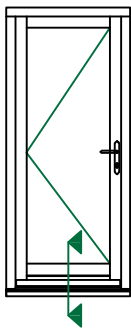
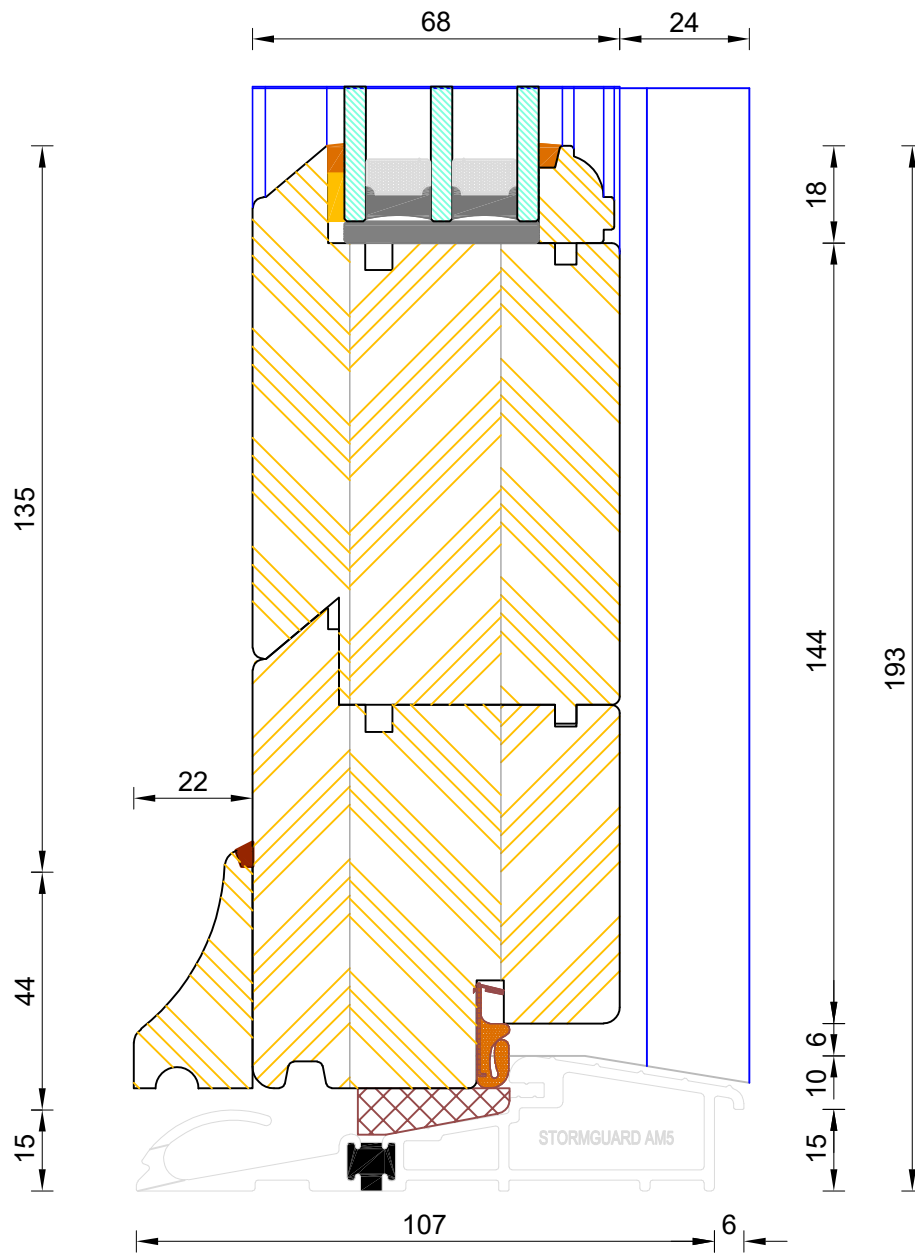

Traditional Open Out Flush Entrance Door
Triple Glazed - Mobility Thresh

DIMENSIONS	PLOT SIZE	SCALE	DATE	REV	DWG NO.
MM	A3	1:1	10.08.2022	A	2465

Please consider the environment before printing