

16

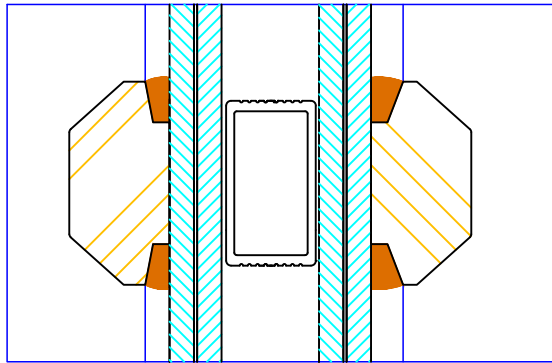

25

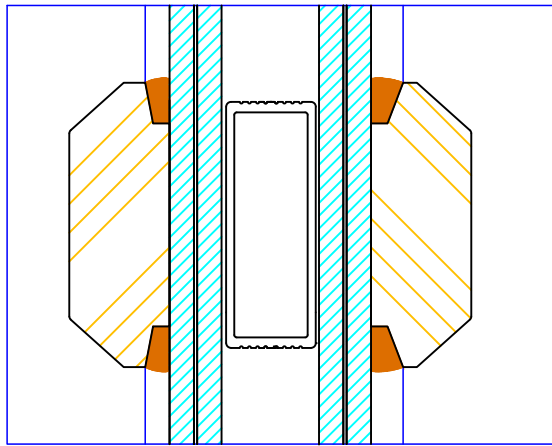

35

60 (varies min 60/ max 137mm)

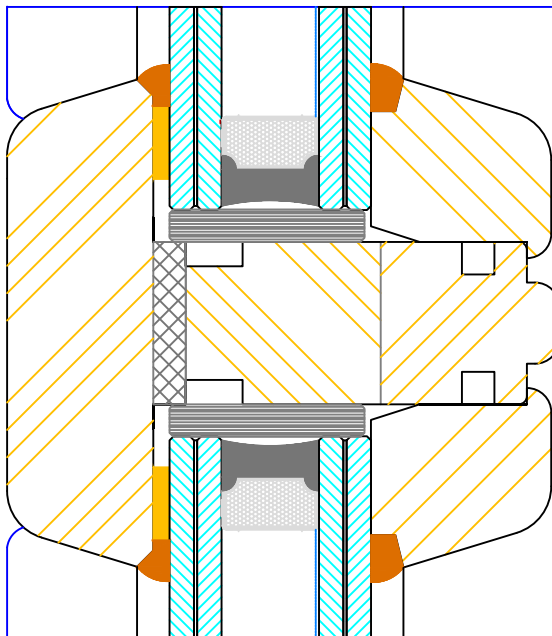

22
16
22

68



Bereco

**Creative Open In Flush Entrance Door
Bar Options**

DIMENSIONS	PLOT SIZE	SCALE	DATE	REV	DWG NO.
MM	A4	1:1	19.04.2012	A	3402

Please consider the environment before printing

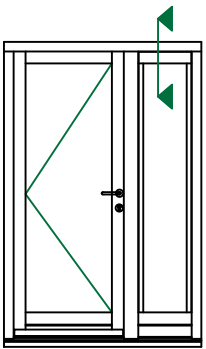
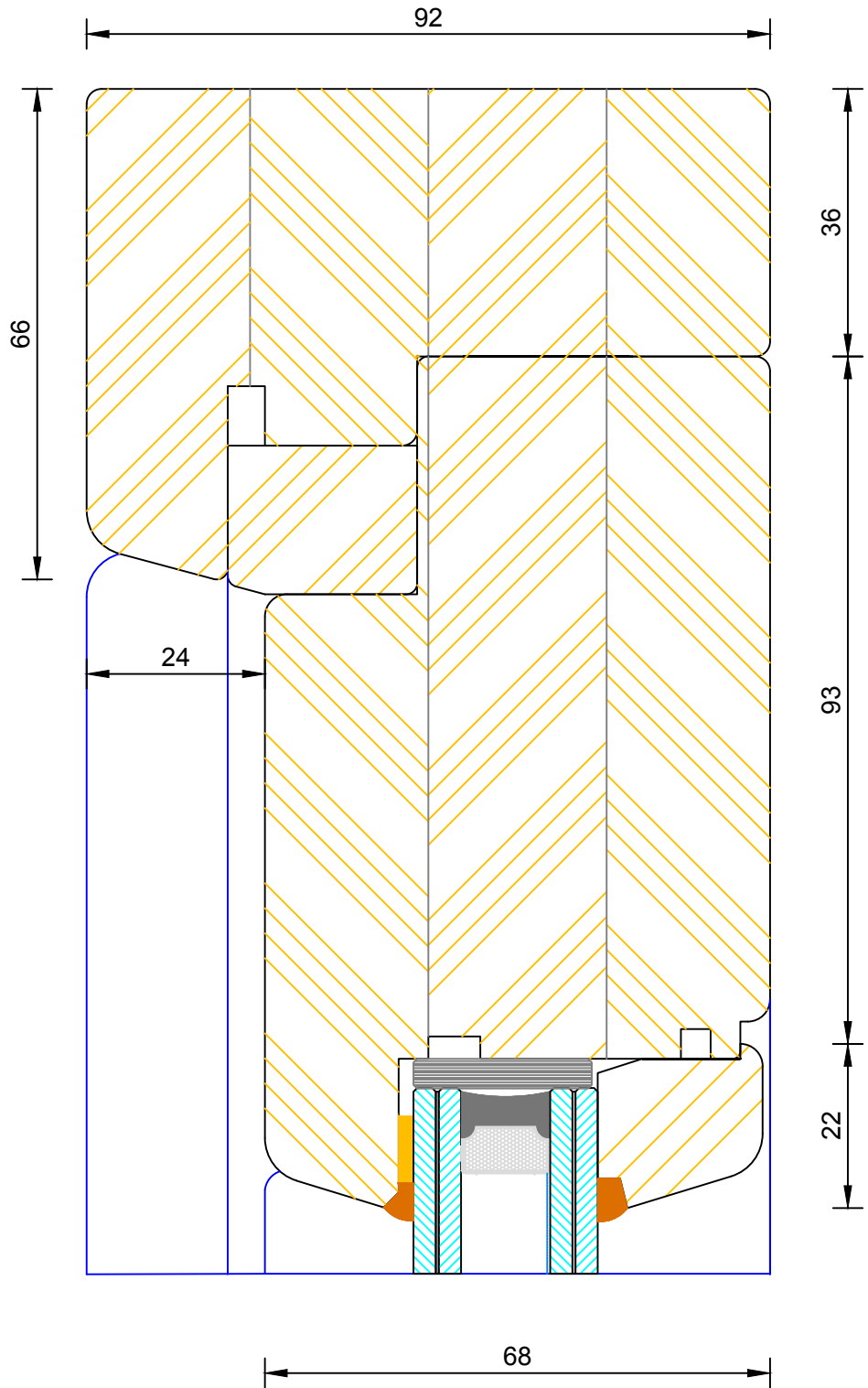

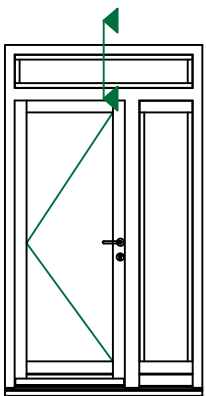
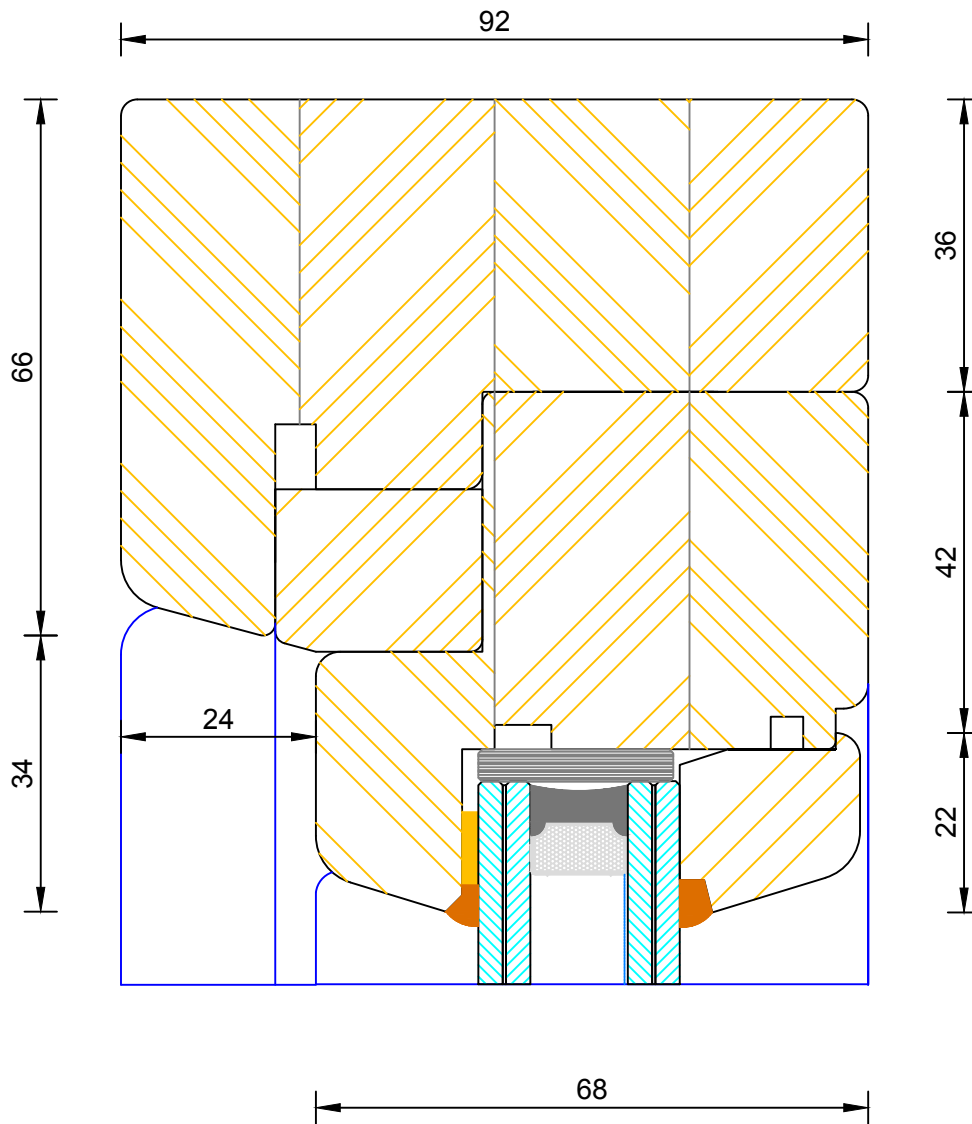

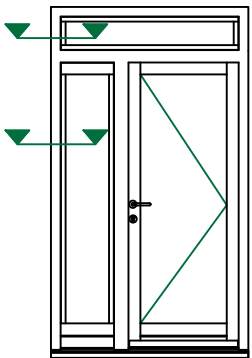
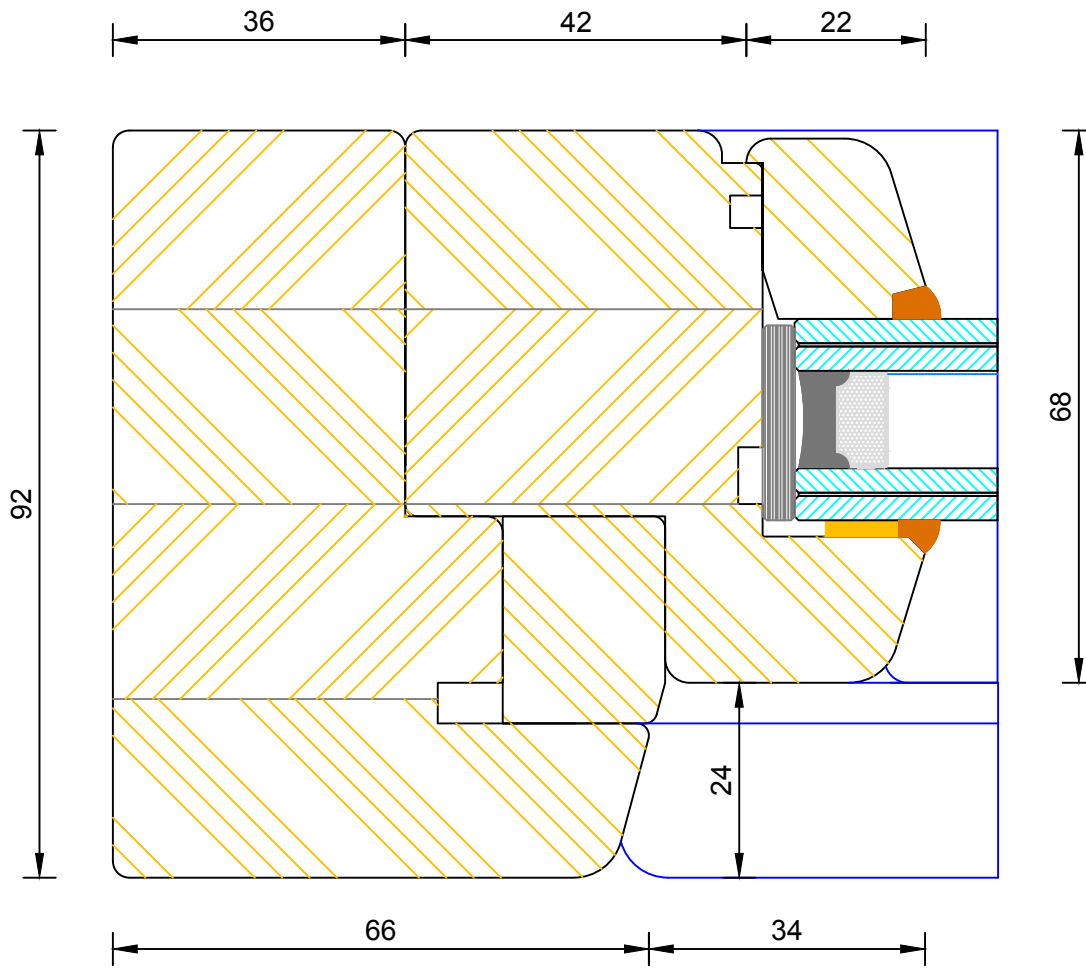

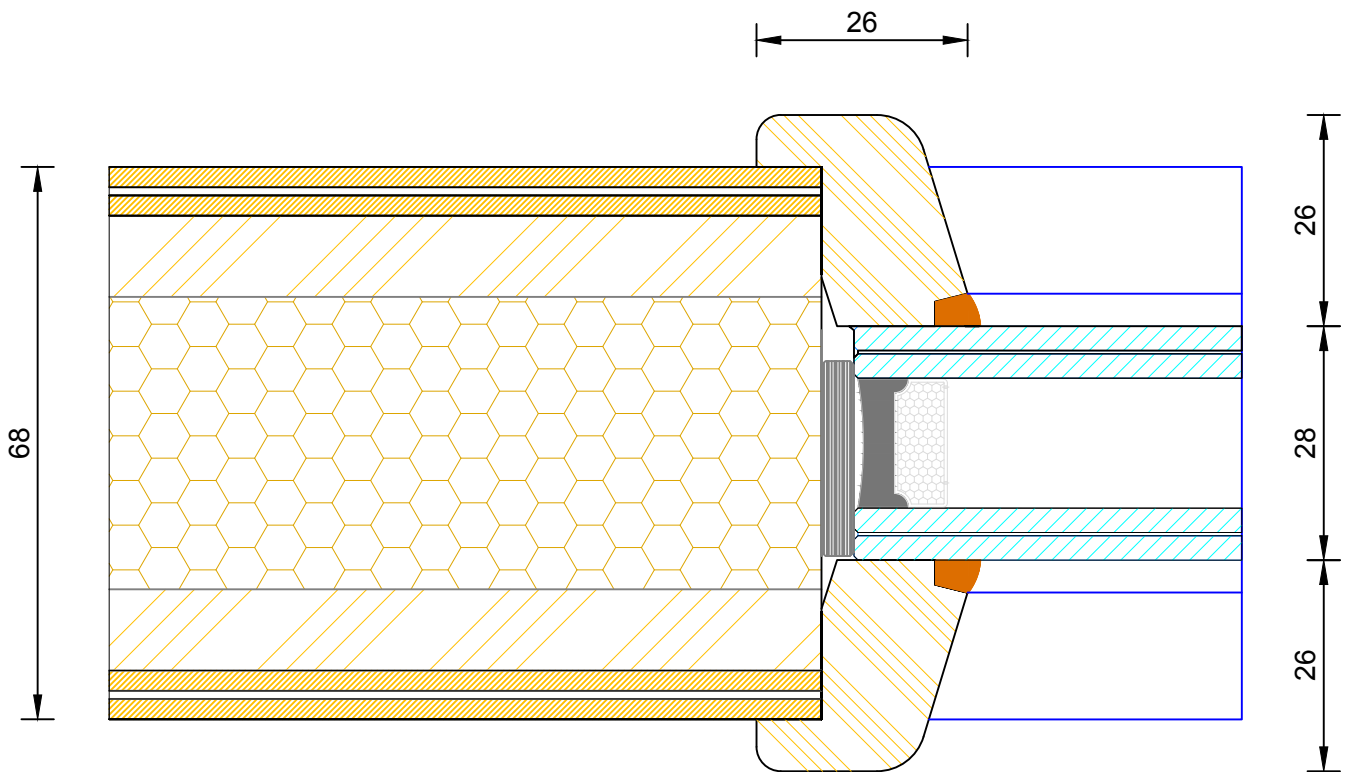

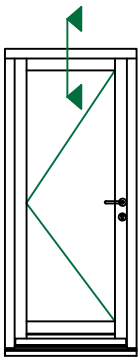
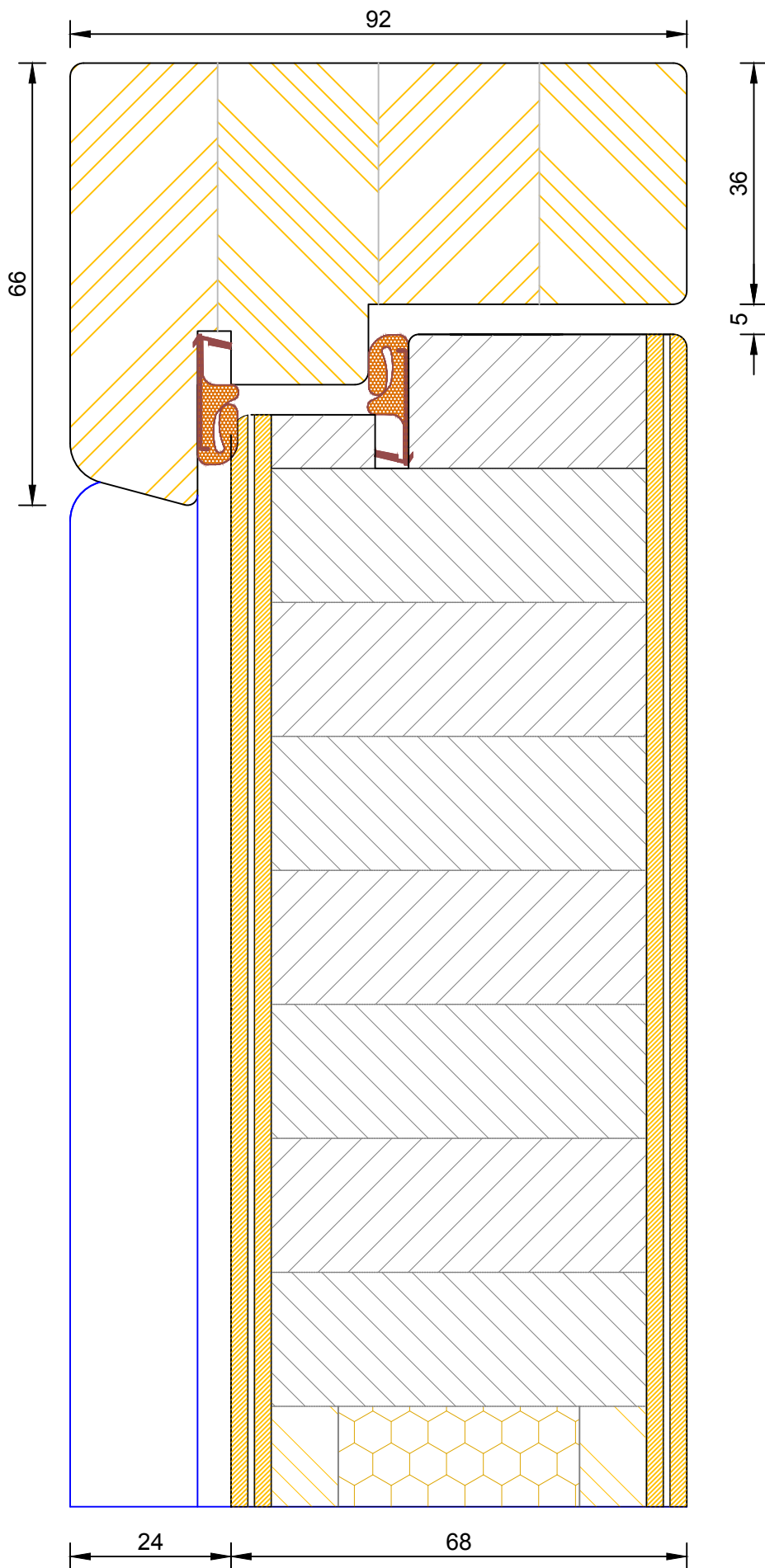

**Creative Open In Flush Entrance Door
Frame & Leaf Head**

DIMENSIONS	PLOT SIZE	SCALE	DATE	REV	DWG NO.
MM	A4	1:1	19.04.2012	A	3409

Please consider the environment before printing

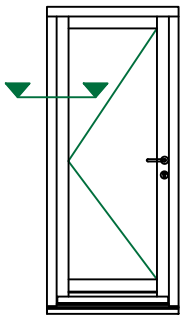
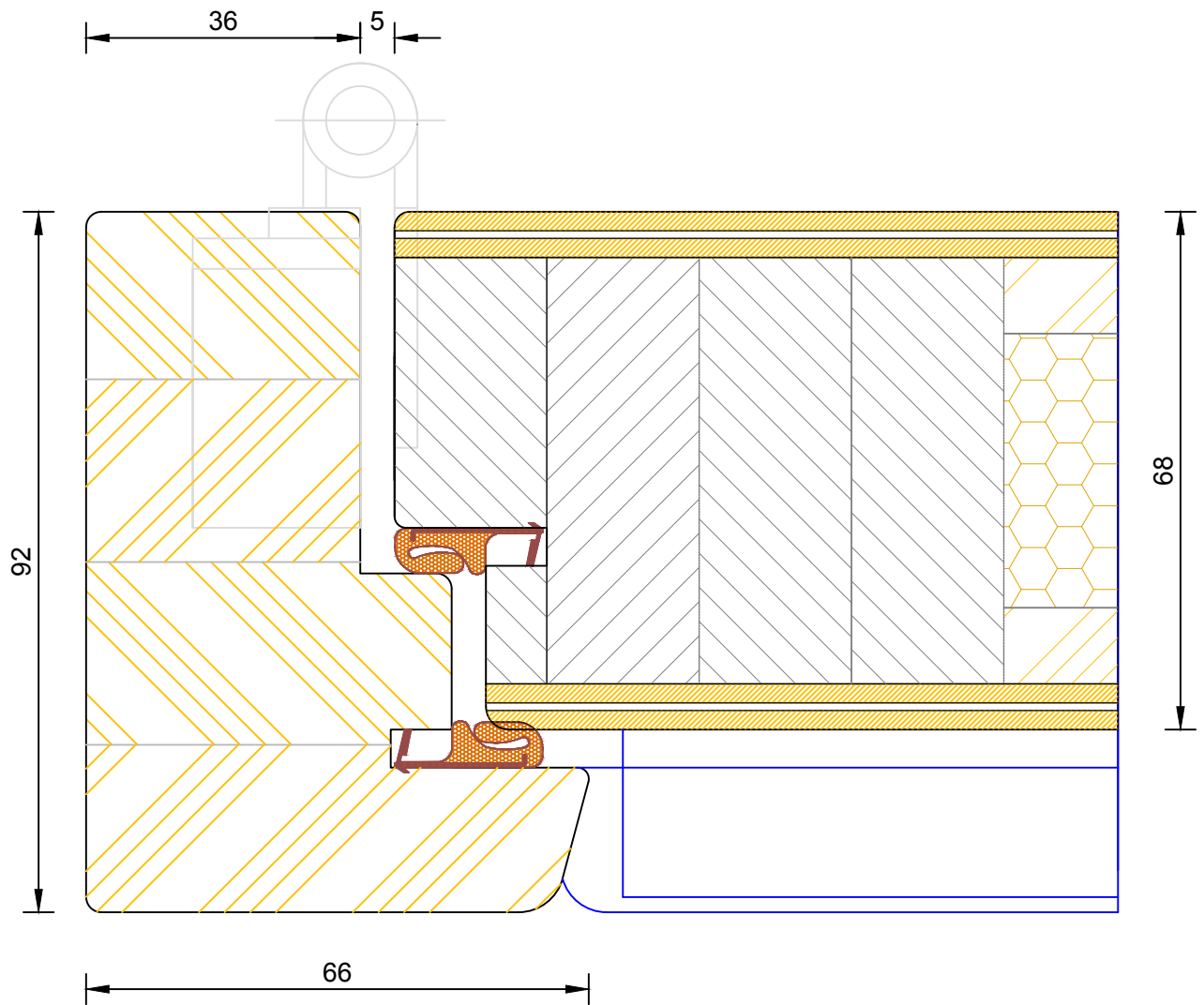

**Creative Open In Flush Entrance Door
Frame & Leaf Jamb (Hinge Side)**

DIMENSIONS	PLOT SIZE	SCALE	DATE	REV	DWG NO.
MM	A4	1:1	19.04.2012	A	3410

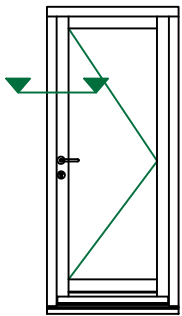
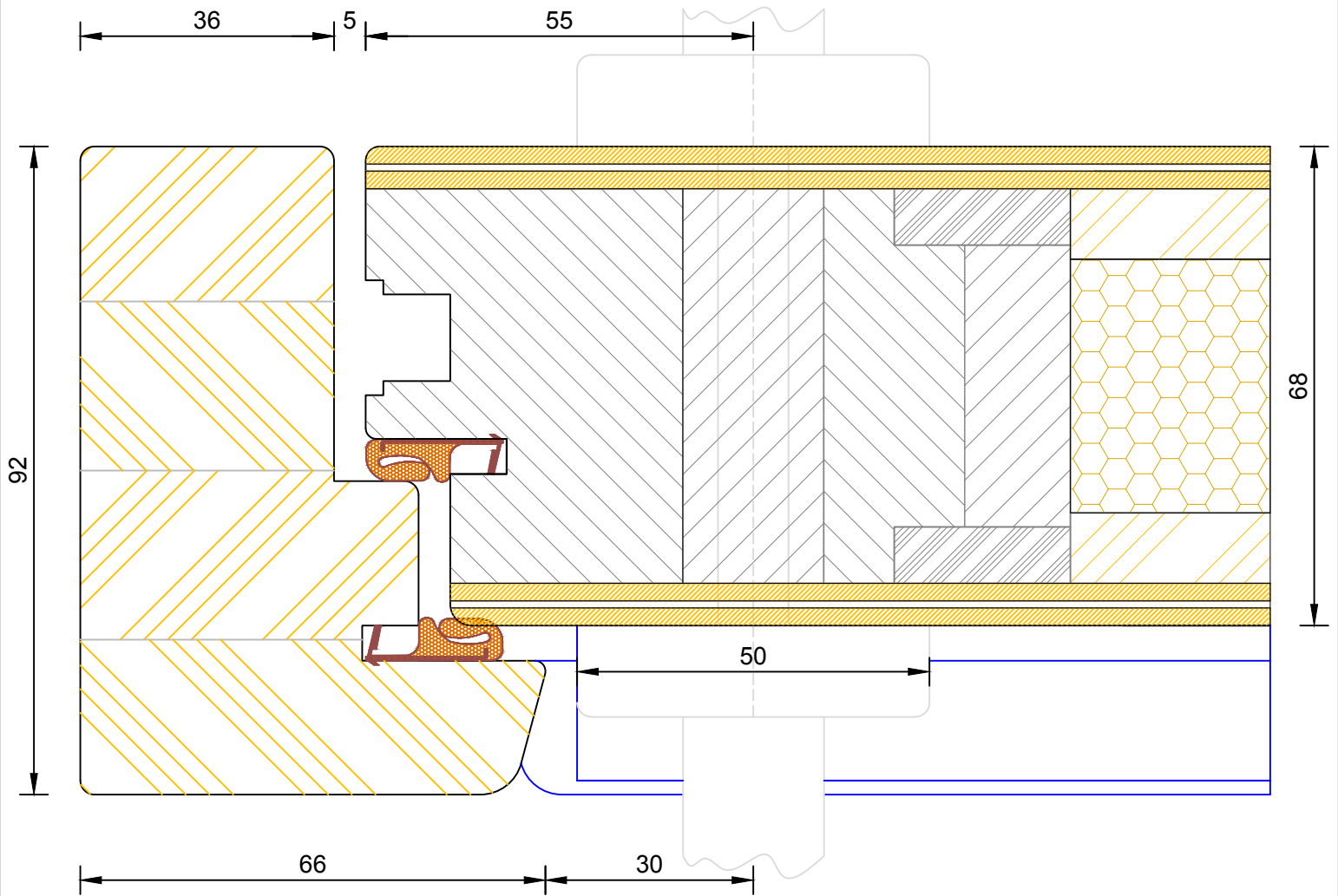

DIMENSIONS	PLOT SIZE	SCALE	DATE	REV	DWG NO.
MM	A4	1:1	19.04.2012	A	3411

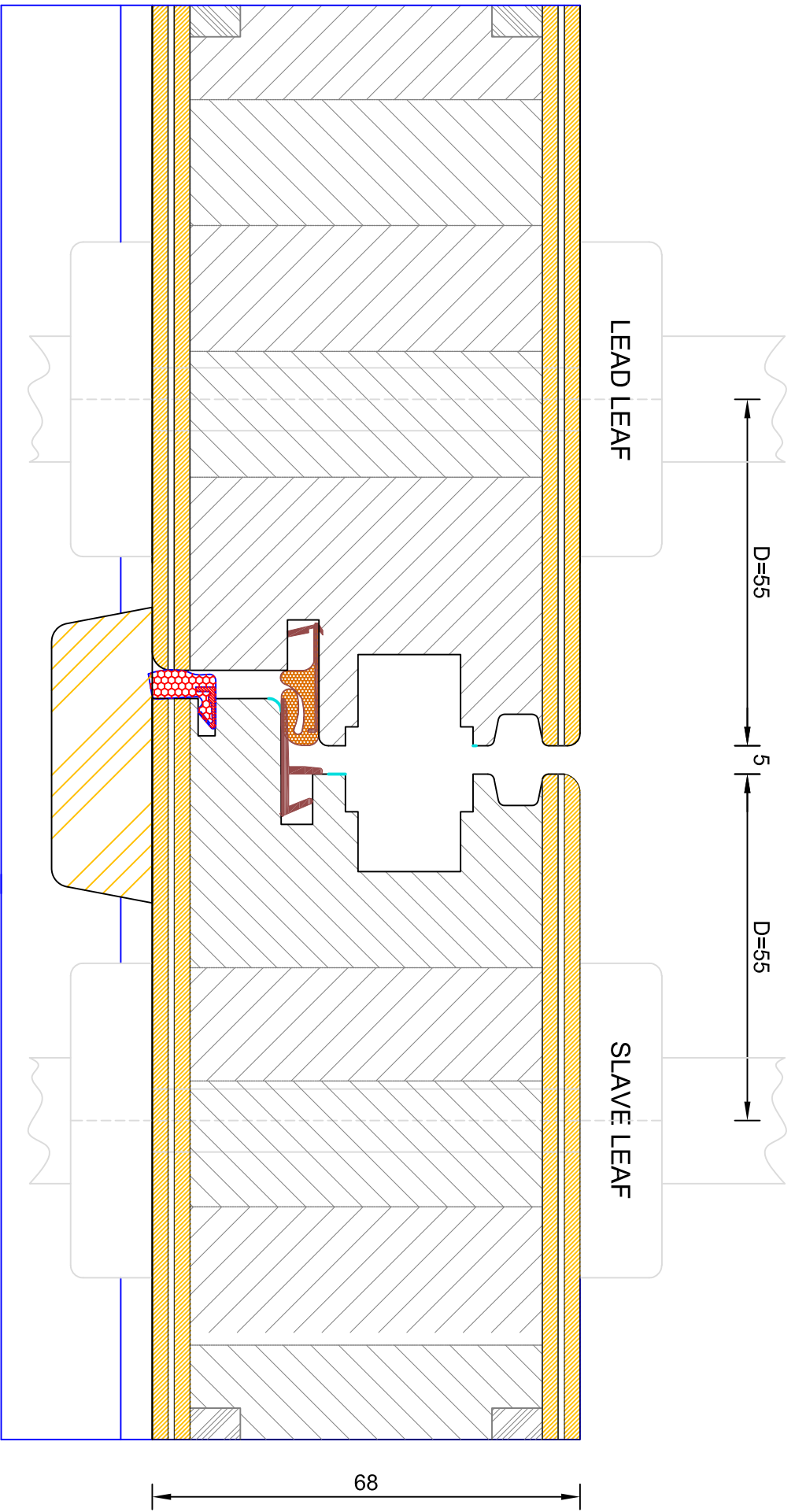

Creative Open In Flush Entrance Door
Flying Mullion

DIMENSIONS	PLOT SIZE	SCALE	DATE	REV	DWG. NO.
MM	A4	1:1	07.02.2011	A	3446

Please consider the environment before printing



Bereco

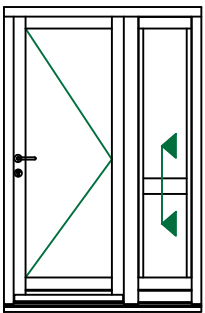
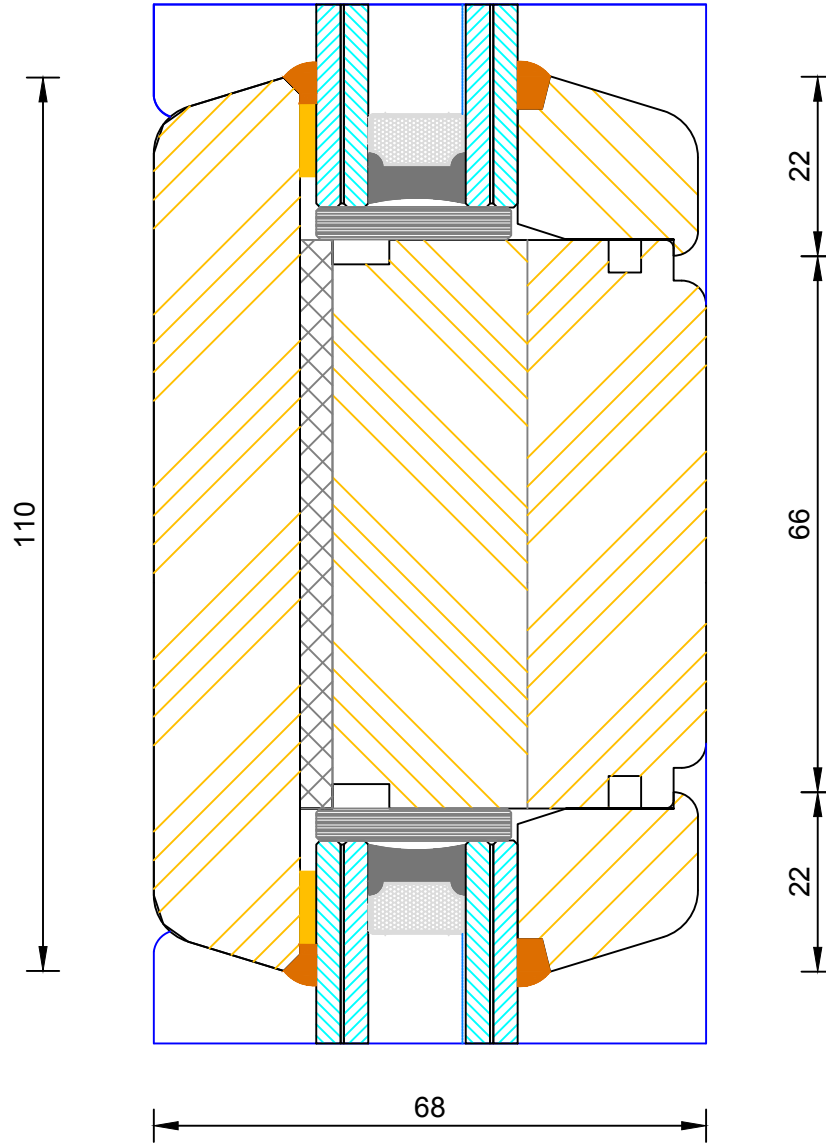

**Creative Open In Flush Entrance Door
Mid Rail, Sidelight (110mm)**

DIMENSIONS	PLOT SIZE	SCALE	DATE	REV	DWG NO.
MM	A4	1:1	19.04.2012	A	3415
Please consider the environment before printing					

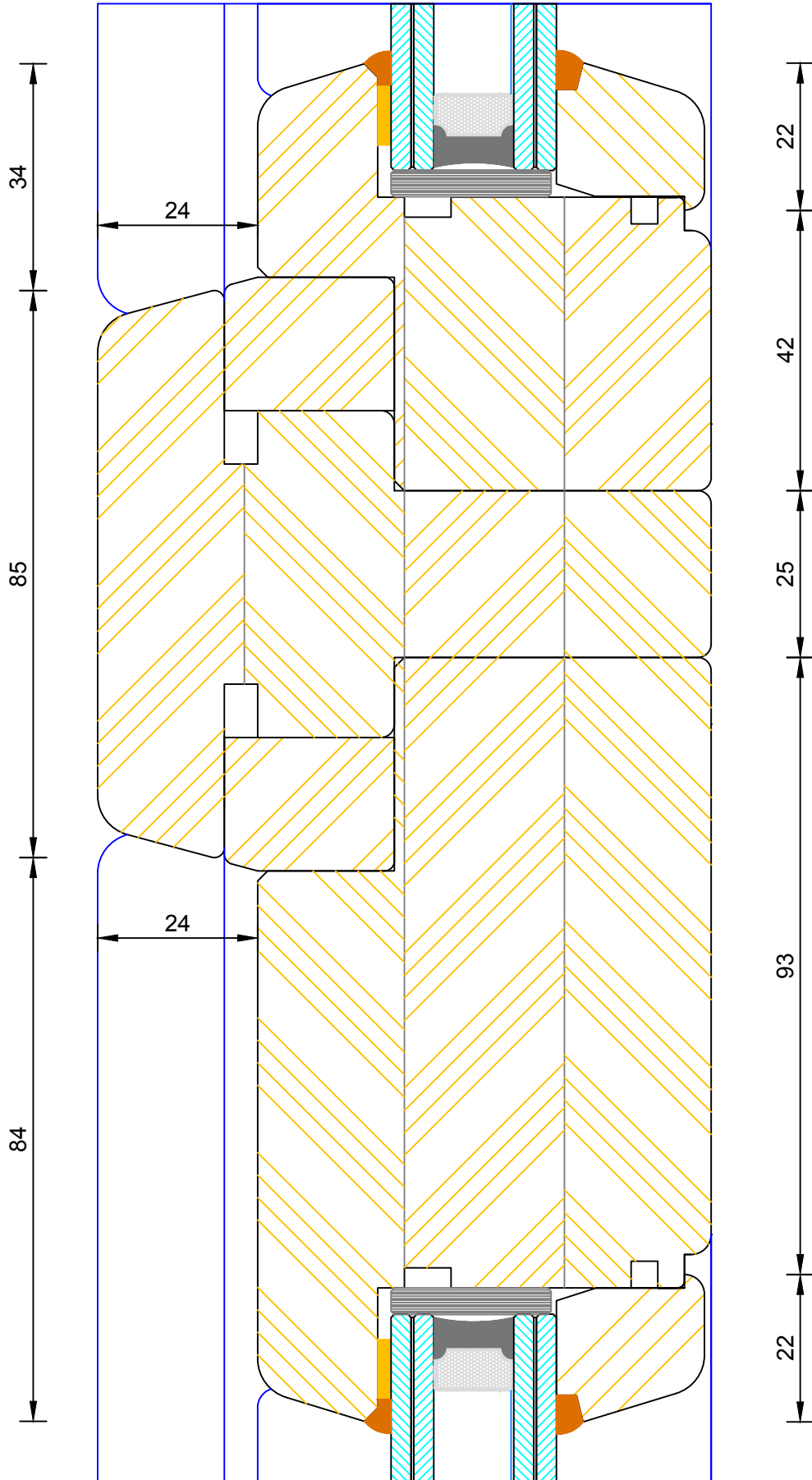
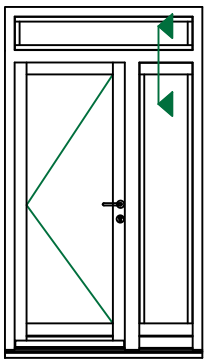

**Creative Open In Flush Entrance Door
Solid Transom (Fanlight / Sidelight)**

DIMENSIONS	PLOT SIZE	SCALE	DATE	REV	DWG NO.
MM	A4	1:1	19.04.2012	A	3416

Please consider the environment before printing

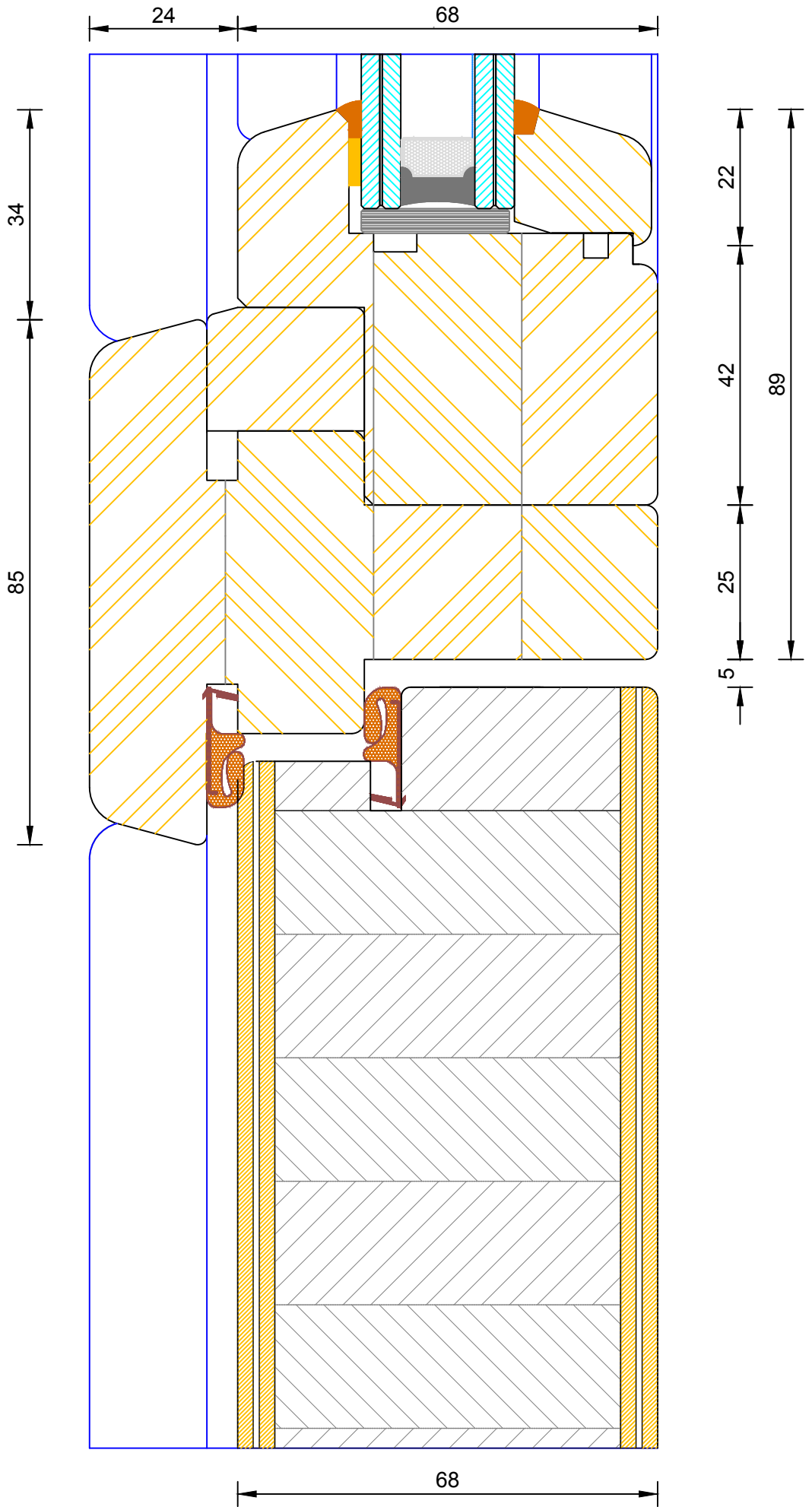
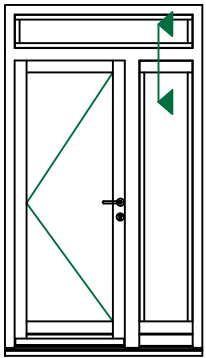

**Creative Open In Flush Entrance Door
Solid Transom (Fanlight / Door Leaf)**

DIMENSIONS	PLOT SIZE	SCALE	DATE	REV	DWG NO.
MM	A4	1:1	19.04.2012	A	3417

Please consider the environment before printing



Bereco

Creative Open In Flush Entrance Door Solid Mullion (Fixed Light / Fixed Light)

DIMENSIONS	PLOT SIZE	SCALE	DATE	REV	DWG. NO.
MM	A4	1:1	19.04.2012	A	3418

Please consider the environment before printing

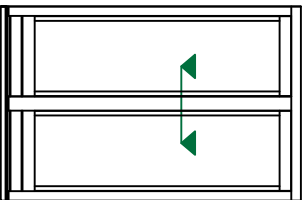
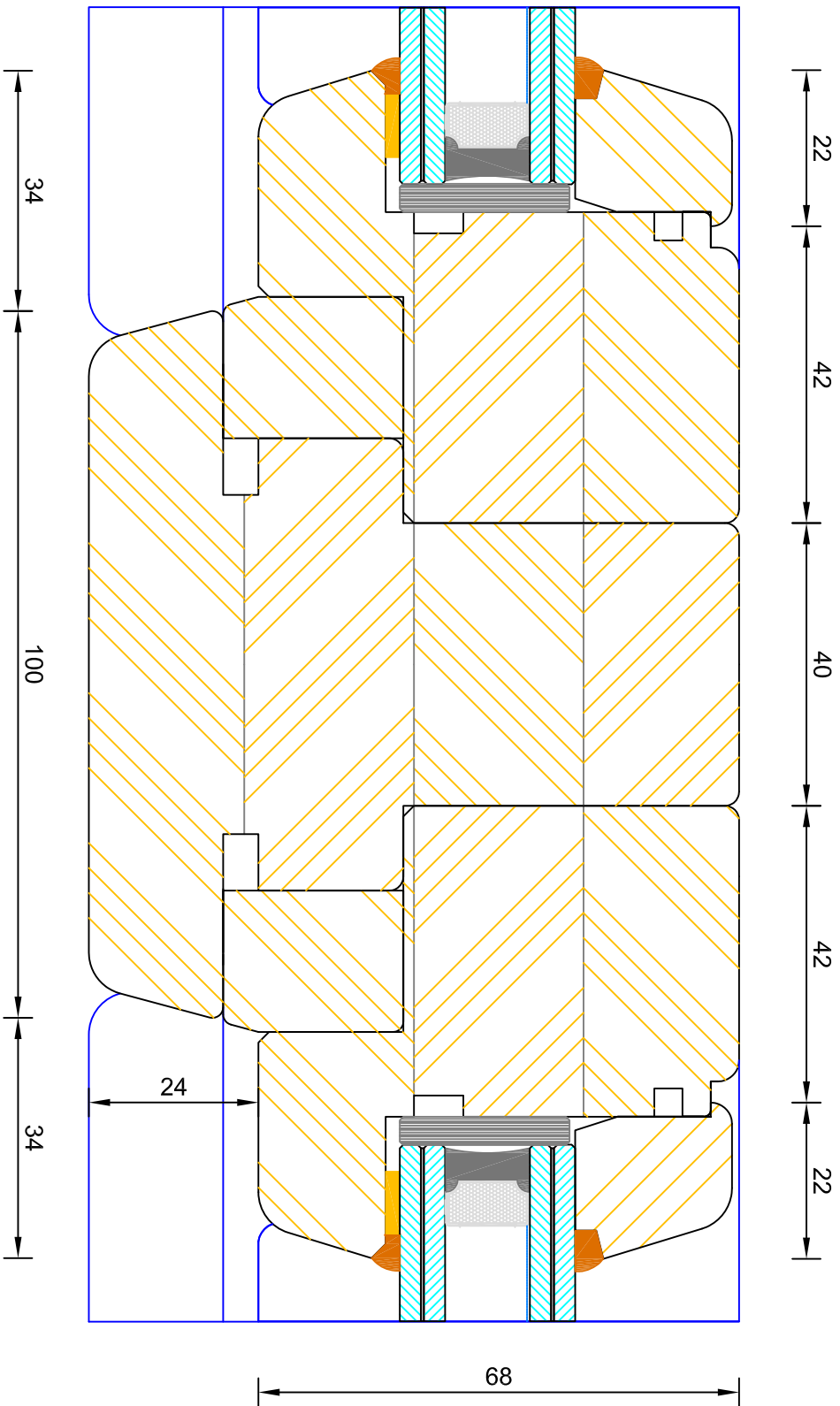

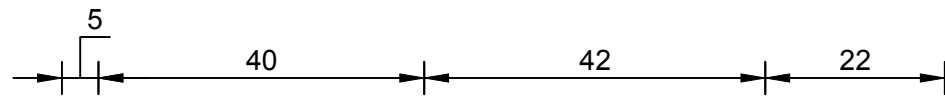

Note: Hinge colour available in Stainless Steel only.

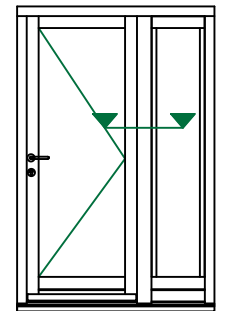
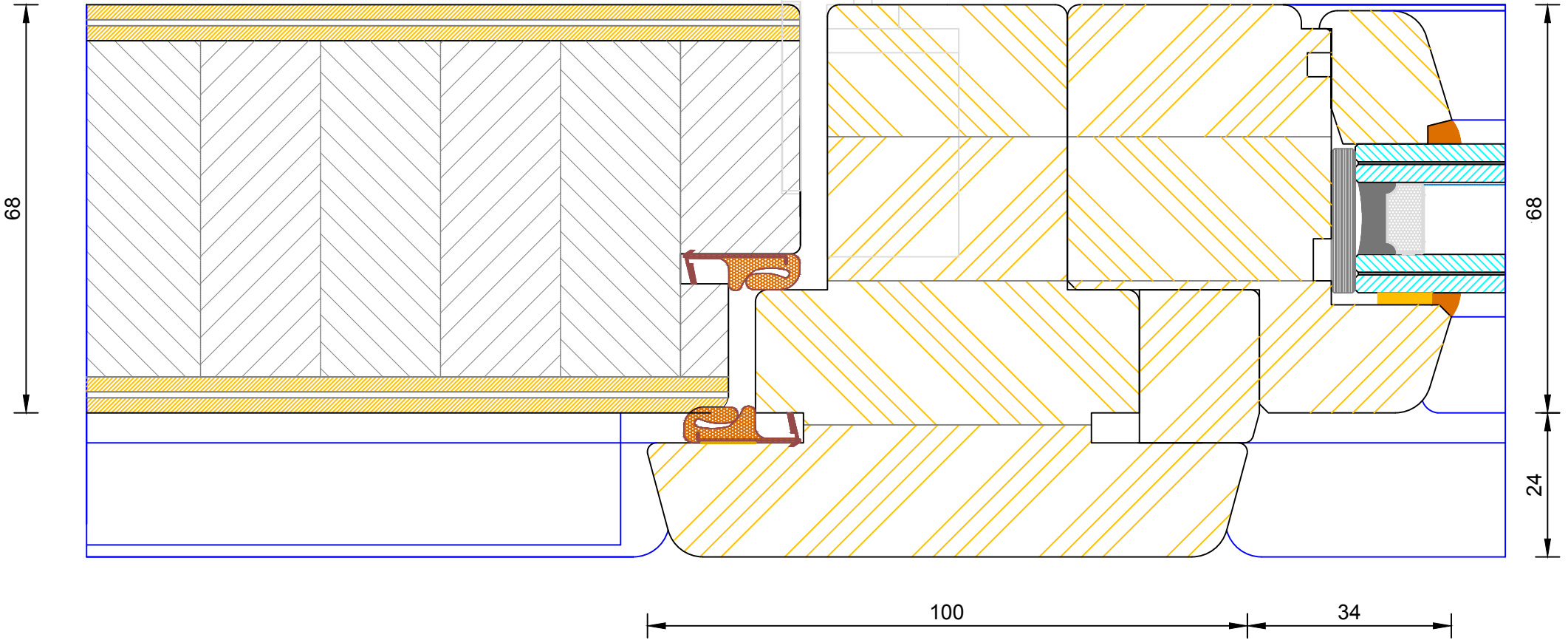

**Creative Open In Flush Entrance Door
Solid Mullion (Leaf / Side Light)**

DIMENSIONS	PLOT SIZE	SCALE	DATE	REV	DWG NO.
MM	A4	1:1	19.04.2012	A	3419
Please consider the environment before printing					



Bereco

Creative Open In Flush Entrance Door Solid Mullion (Leaf / Side Light)

DIMENSIONS	PLOT SIZE	SCALE	DATE	REV	DWG. NO.
MM	A4	1:1	19.04.2012	A	3420

Please consider the environment before printing

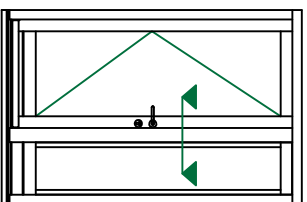
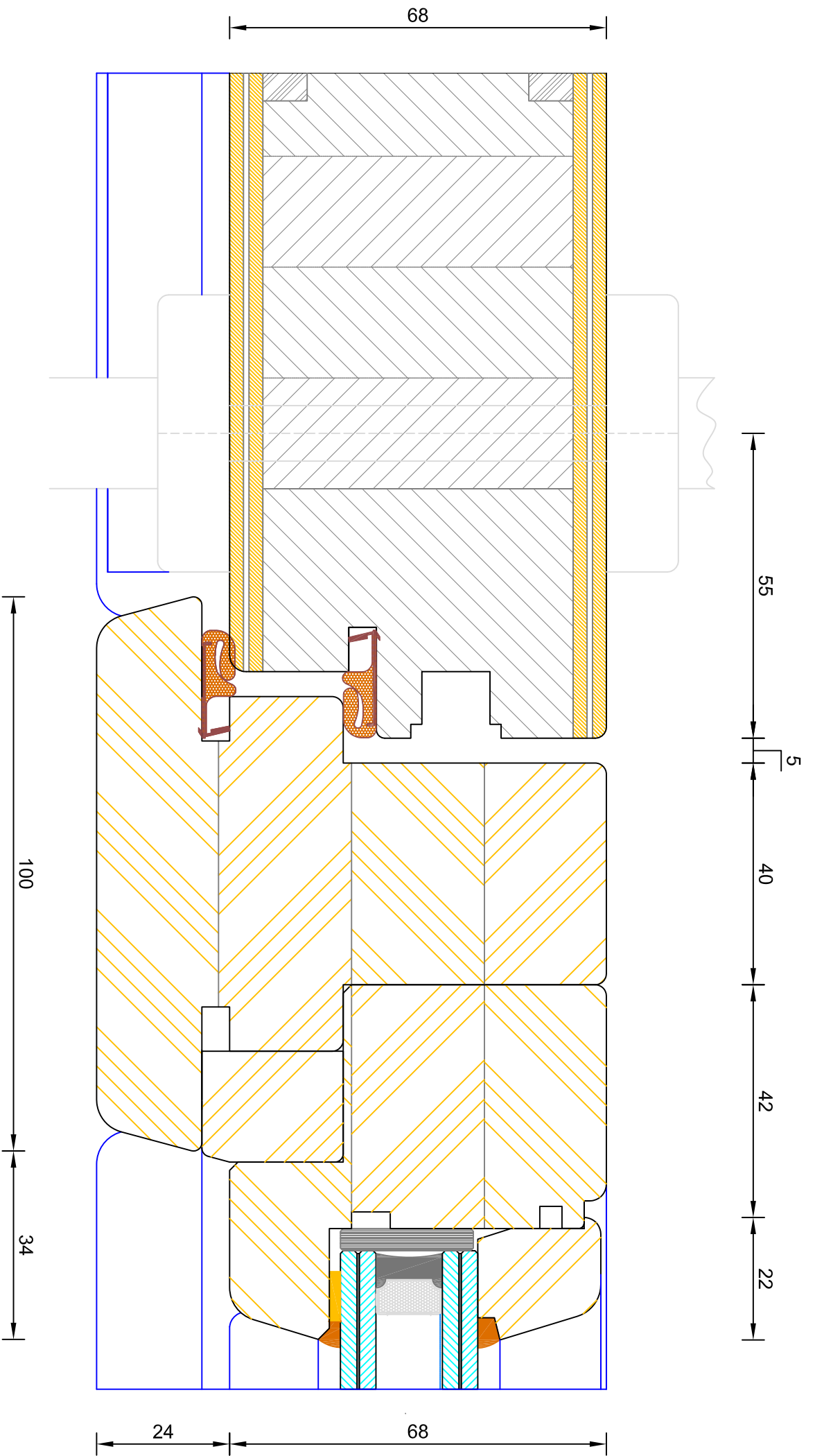

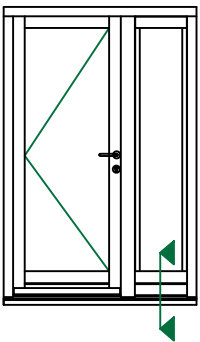
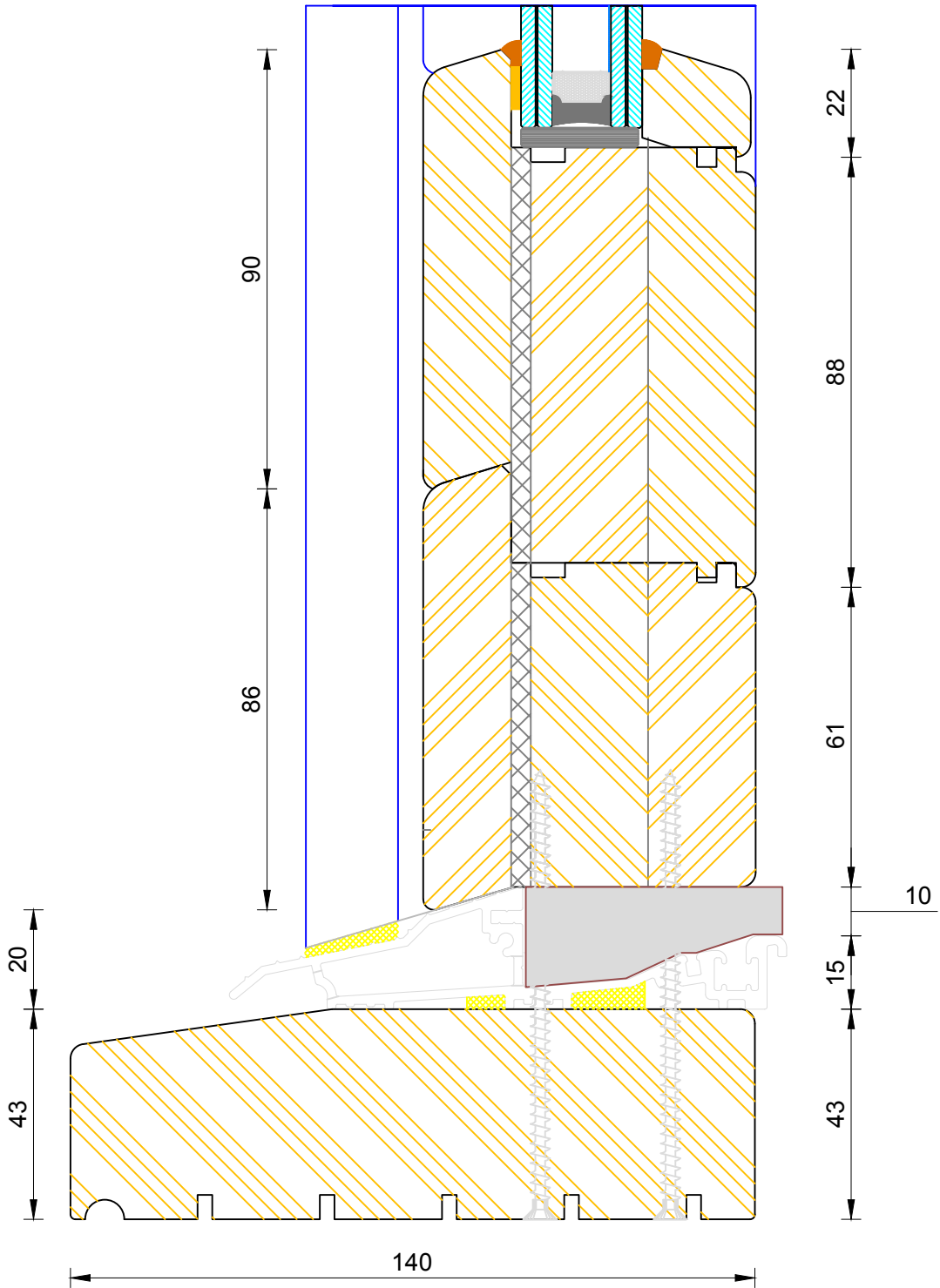

**Creative Open In Flush Entrance Door
Standard Thresh (Sidelight)**

DIMENSIONS	PLOT SIZE	SCALE	DATE	REV	DWG NO.
MM	A3	1:1	19.04.2012	A	3406
Please consider the environment before printing					

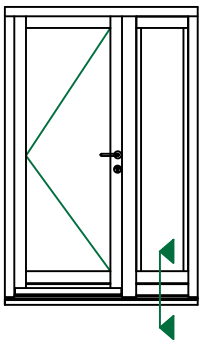
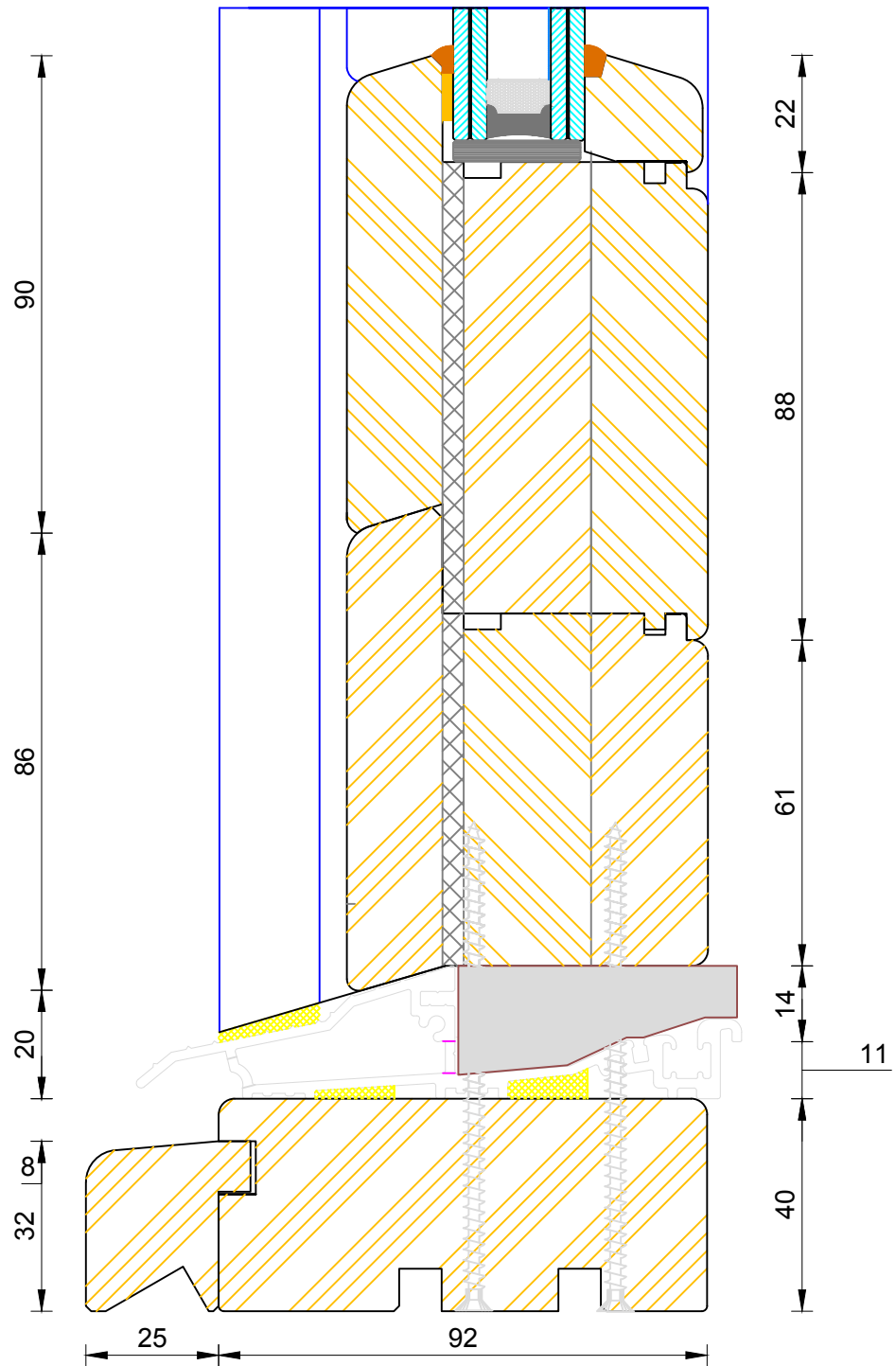

CILL EXTENSION - available options: 25mm (117mm o/a) / 47mm (139mm o/a) / 62mm (154mm o/a) / 87mm (179mm o/a) / 114mm (206mm o/a) / 125mm (217mm o/a) / 140mm (232mm o/a)

NOTE: Cill Extensions should be supported from underneath; the maximum overhang over Brick / Blockwork for cill extension should not exceed 25mm in order to avoid damage when stepped on. Warranties are invalidated when fitted with overhang in excess to that.

If not otherwise stated, Hardwood Threshold will be painted the same colour as Frame.



Creative Open In Flush Entrance Door Coupling Thresh (Sidelight)

DIMENSIONS	PLOT SIZE	SCALE	DATE	REV	DWG NO.
MM	A3	1:1	19.04.2012	A	3407
Please consider the environment before printing					

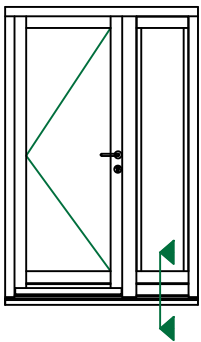
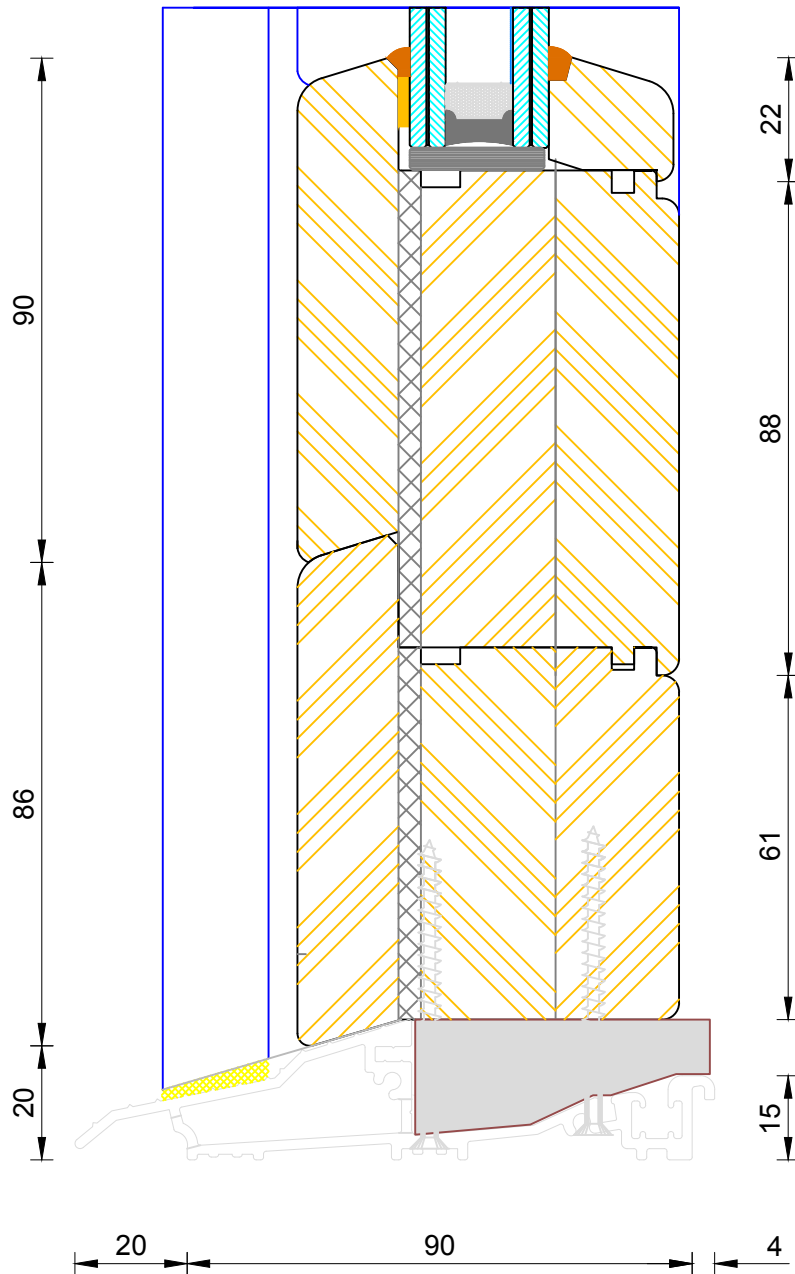

**Creative Open In Flush Entrance Door
Mobility Thresh (Sidelight)**

DIMENSIONS	PLOT SIZE	SCALE	DATE	REV	DWG NO.
MM	A3	1:1	19.04.2012	A	3408
Please consider the environment before printing					

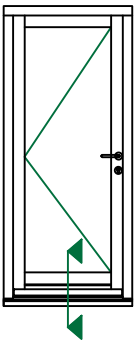
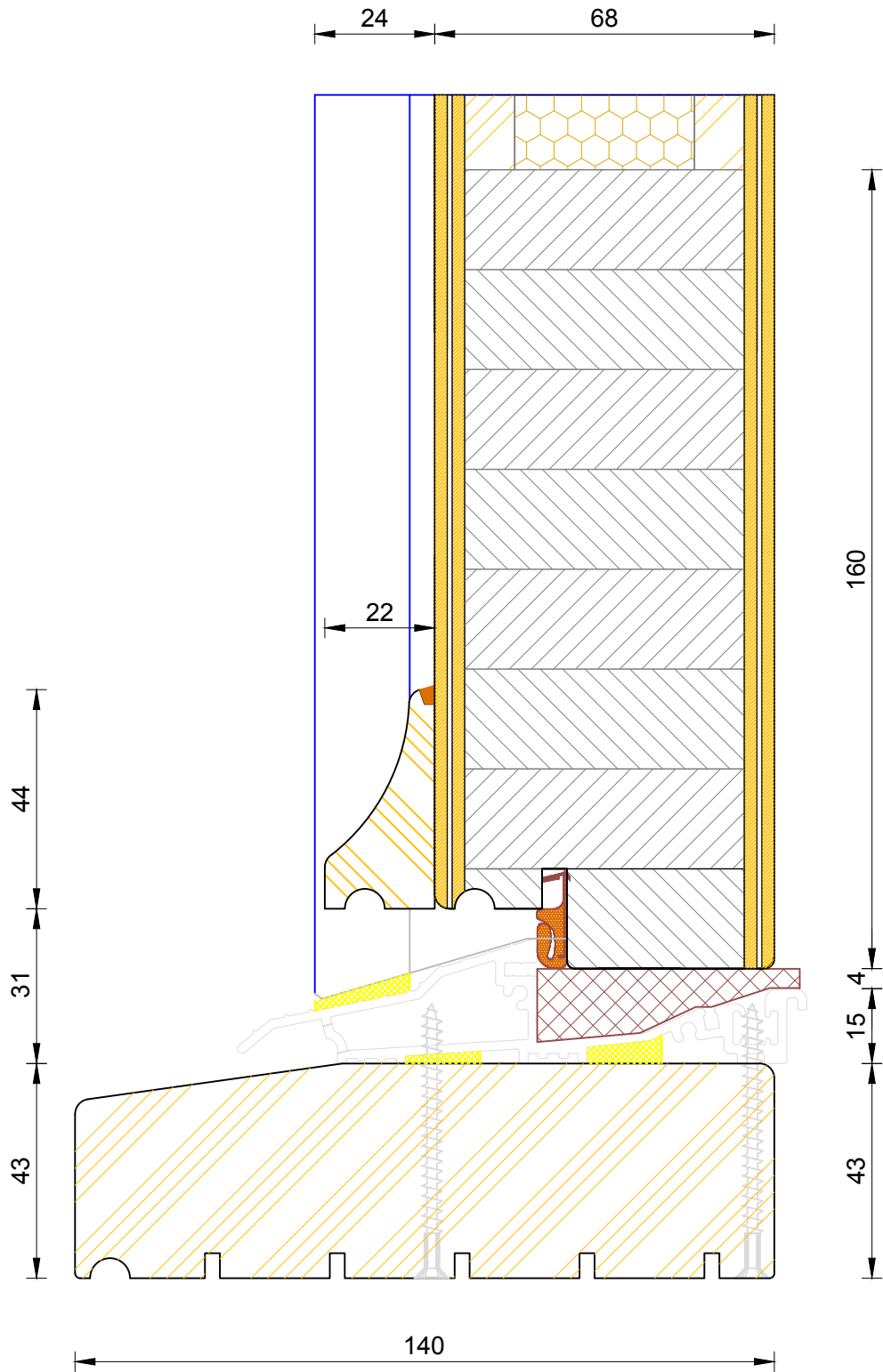

**Creative Open In Flush Entrance Door
Standard Thresh (140x43mm)**

DIMENSIONS	PLOT SIZE	SCALE	DATE	REV	DWG NO.
MM	A3	1:1	19.04.2012	A	3412

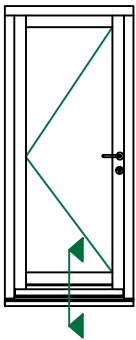
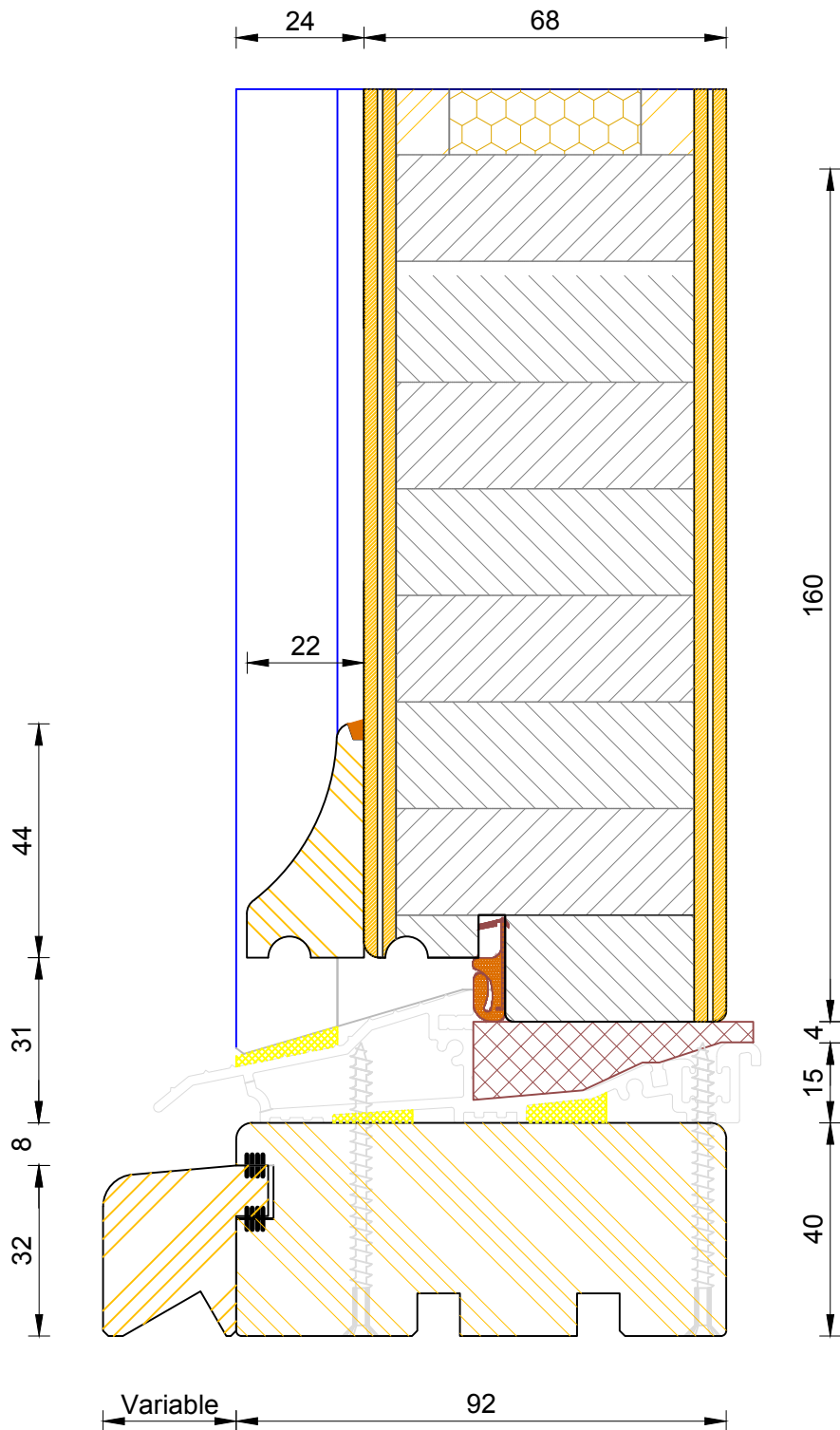

CILL EXTENSION - available options: 25mm (117mm o/a) / 47mm (139mm o/a) / 62mm (154mm o/a) / 87mm (179mm o/a) / 114mm (206mm o/a) / 125mm (217mm o/a) / 140mm (232mm o/a)

NOTE: Cill Extensions should be supported from underneath; the maximum overhang over Brick / Blockwork for cill extension should not exceed 25mm in order to avoid damage when stepped on. Warranties are invalidated when fitted with overhang in excess to that.

If not otherwise stated, Hardwood Threshold will be painted the same colour as Frame.

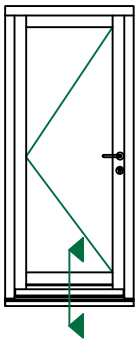
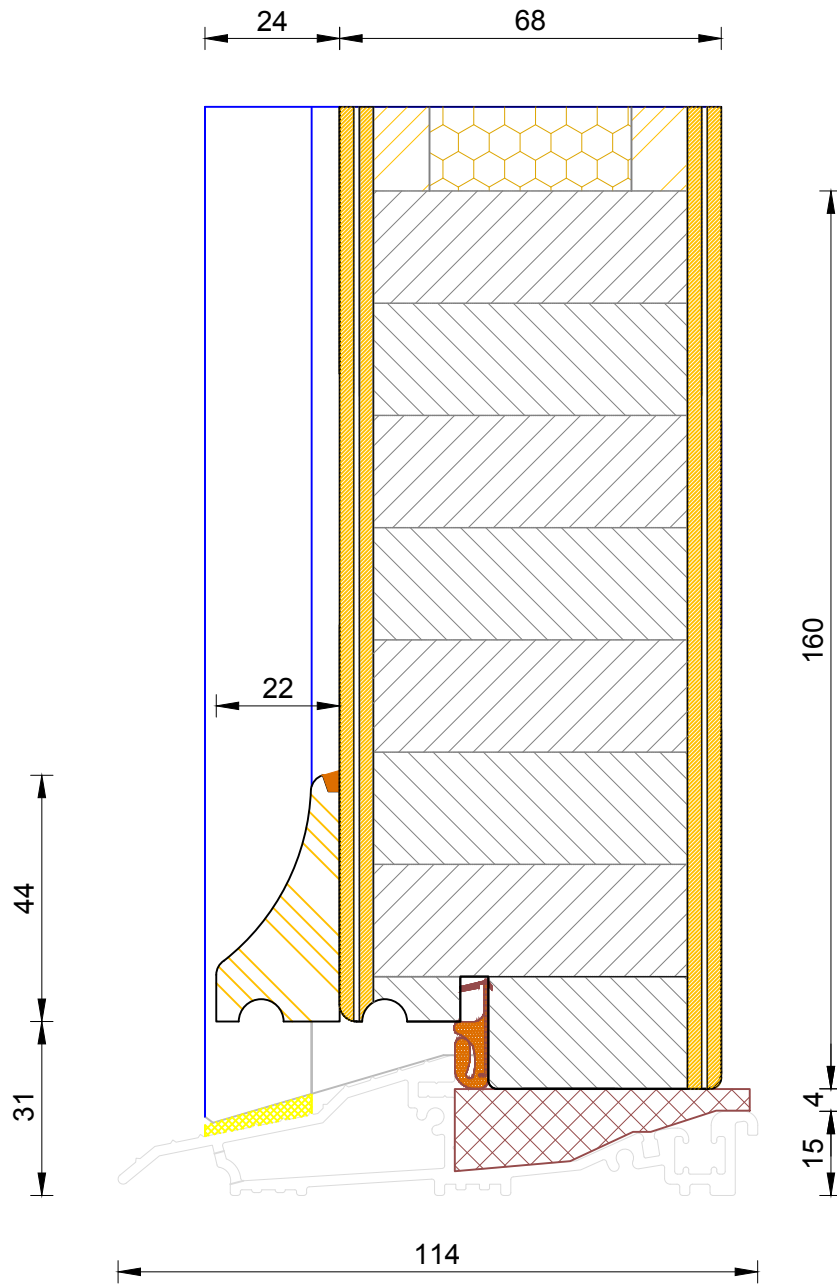

**Creative Open In Flush Entrance Door
Mobility Thresh**

DIMENSIONS	PLOT SIZE	SCALE	DATE	REV	DWG NO.
MM	A3	1:1	19.04.2012	A	3414
Please consider the environment before printing					