

Creative Open Out Flush Entrance Door Cill Extension Options

DIMENSIONS	PLOT SIZE	SCALE	DATE	REV	DWG NO.
MM	A4	1:1	25.09.2019	B	3501
Please consider the environment before printing					

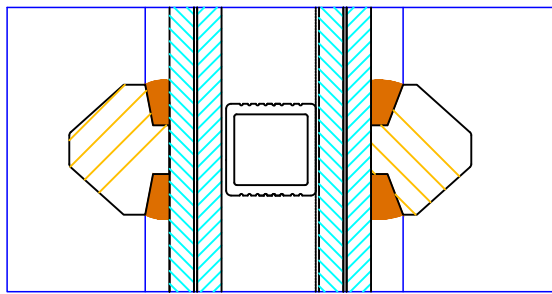

16

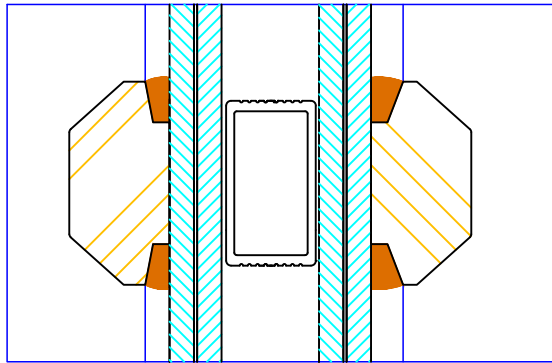

25

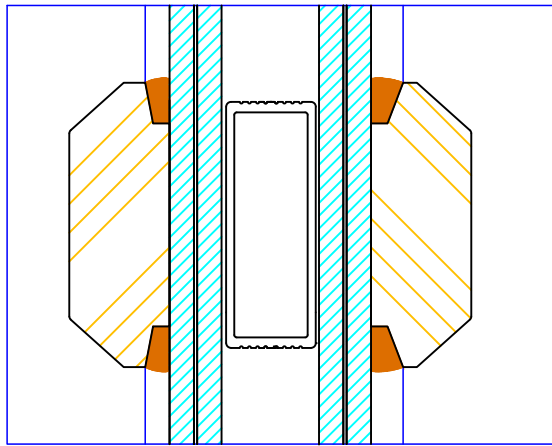

35

60 (varies min 60/ max 137mm)

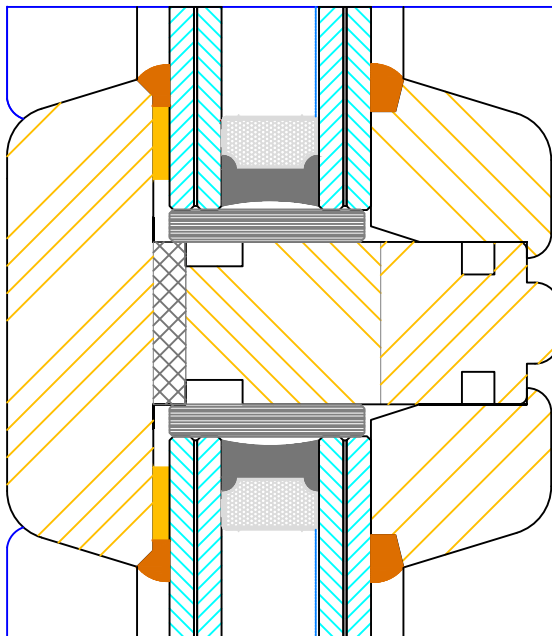

22
16
22

68



Bereco

**Creative Open Out Flush Entrance Door
Bar Options**

DIMENSIONS	PLOT SIZE	SCALE	DATE	REV	DWG NO.
MM	A4	1:1	19.04.2012	A	3502
Please consider the environment before printing					

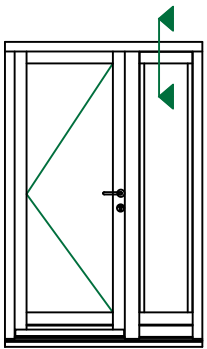
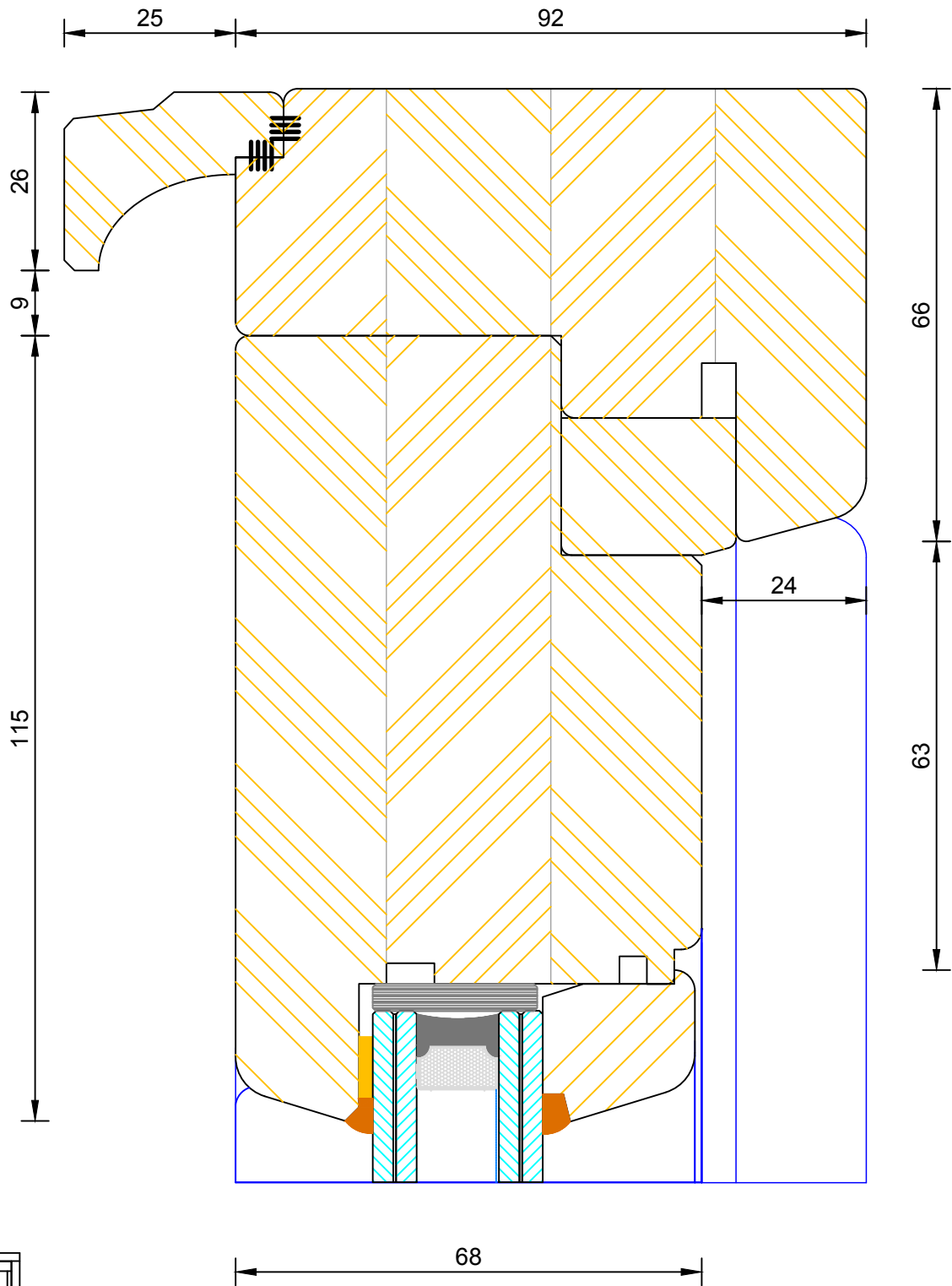

**Creative Open Out Flush Entrance Door
Sidelight Head**

DIMENSIONS	PLOT SIZE	SCALE	DATE	REV	DWG NO.
MM	A4	1:1	19.04.2012	A	3503
Please consider the environment before printing					

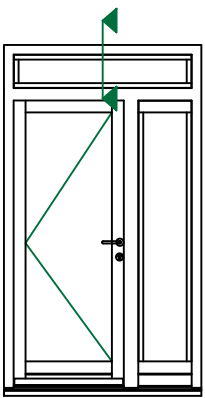
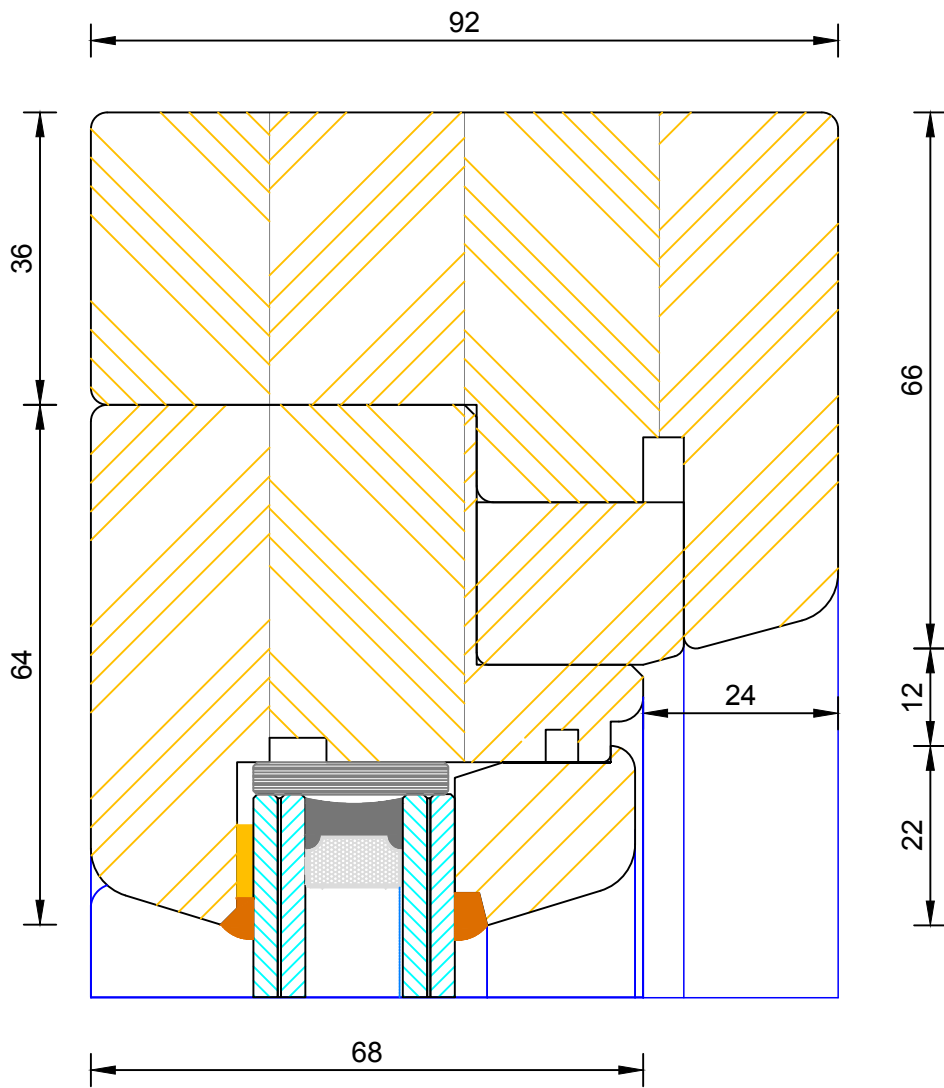

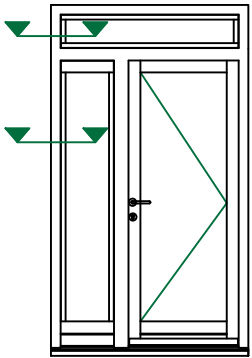
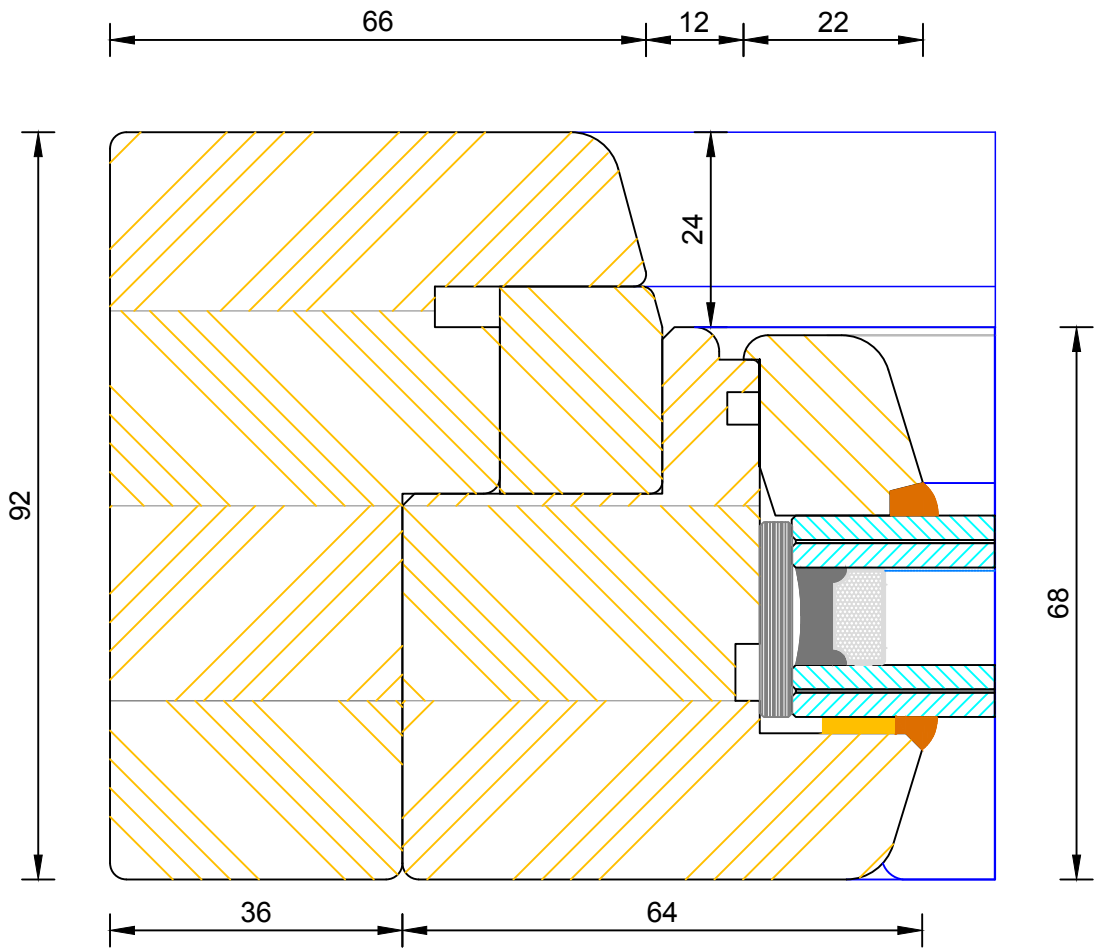

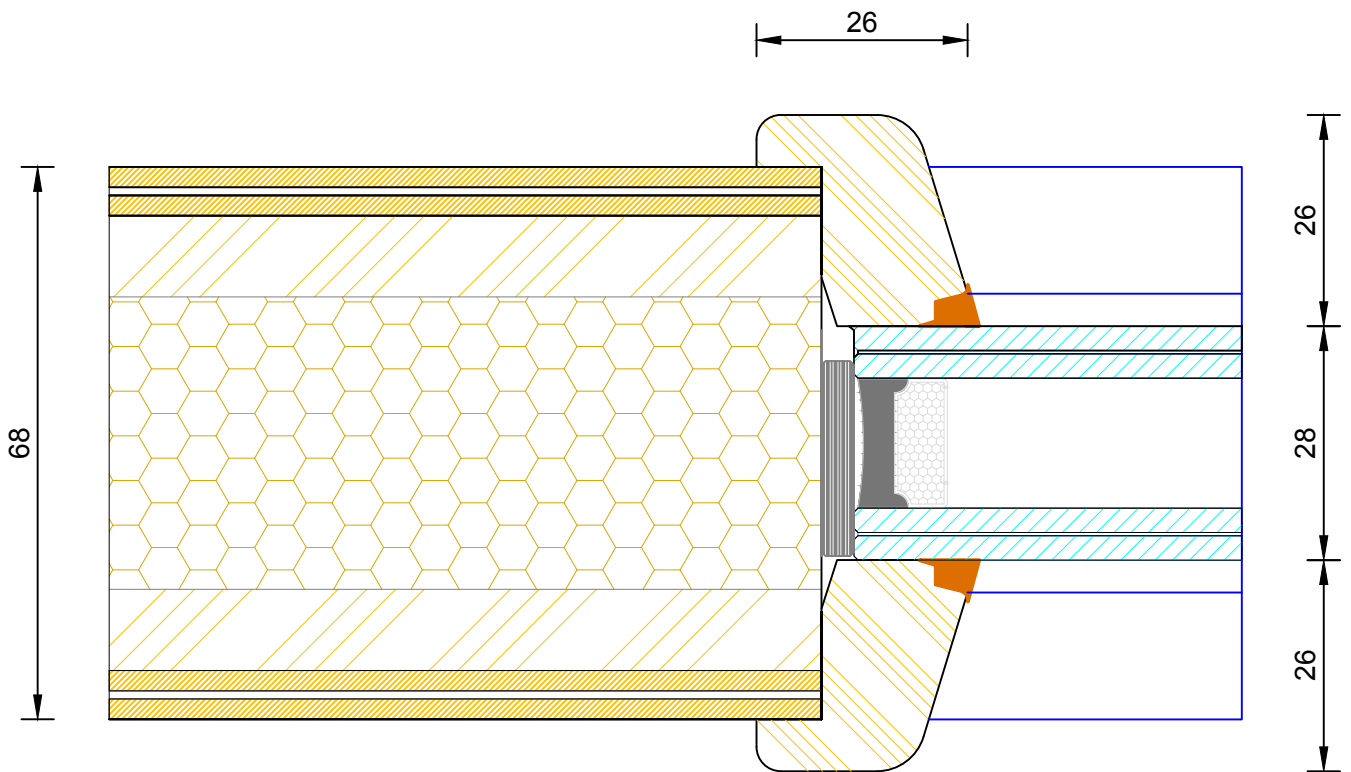

Bereco

**Creative Open Out Flush Entrance Door
Door Leaf Glazing Detail**

DIMENSIONS	PLOT SIZE	SCALE	DATE	REV	DWG NO.
MM	A4	1:1	19.04.2012	A	3545

Please consider the environment before printing

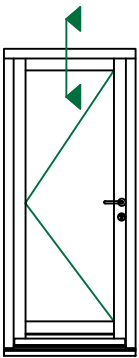
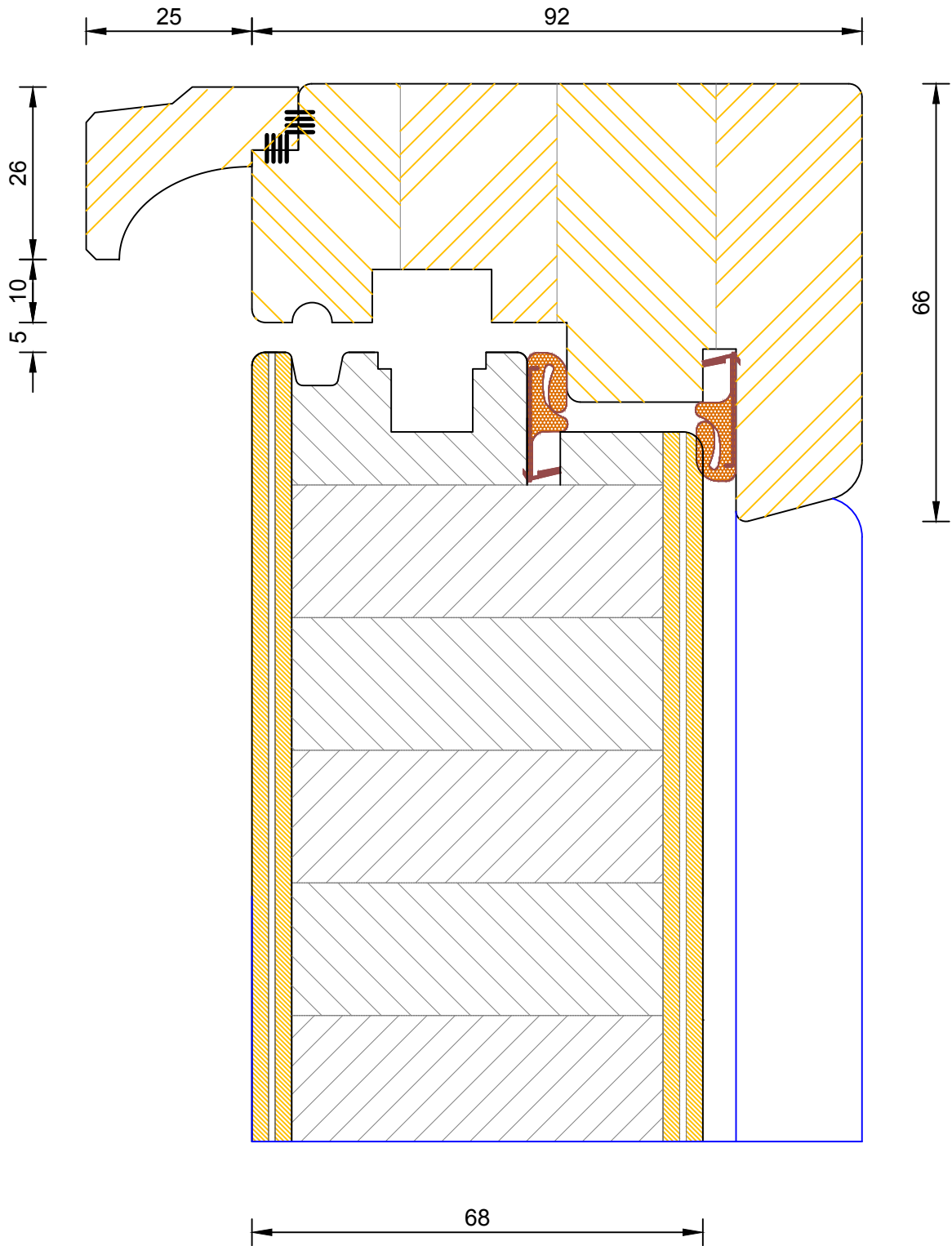

**Creative Open Out Flush Entrance Door
Frame & Leaf Head**

DIMENSIONS	PLOT SIZE	SCALE	DATE	REV	DWG NO.
MM	A4	1:1	19.04.2012	A	3509

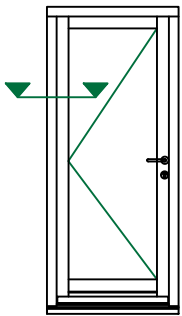
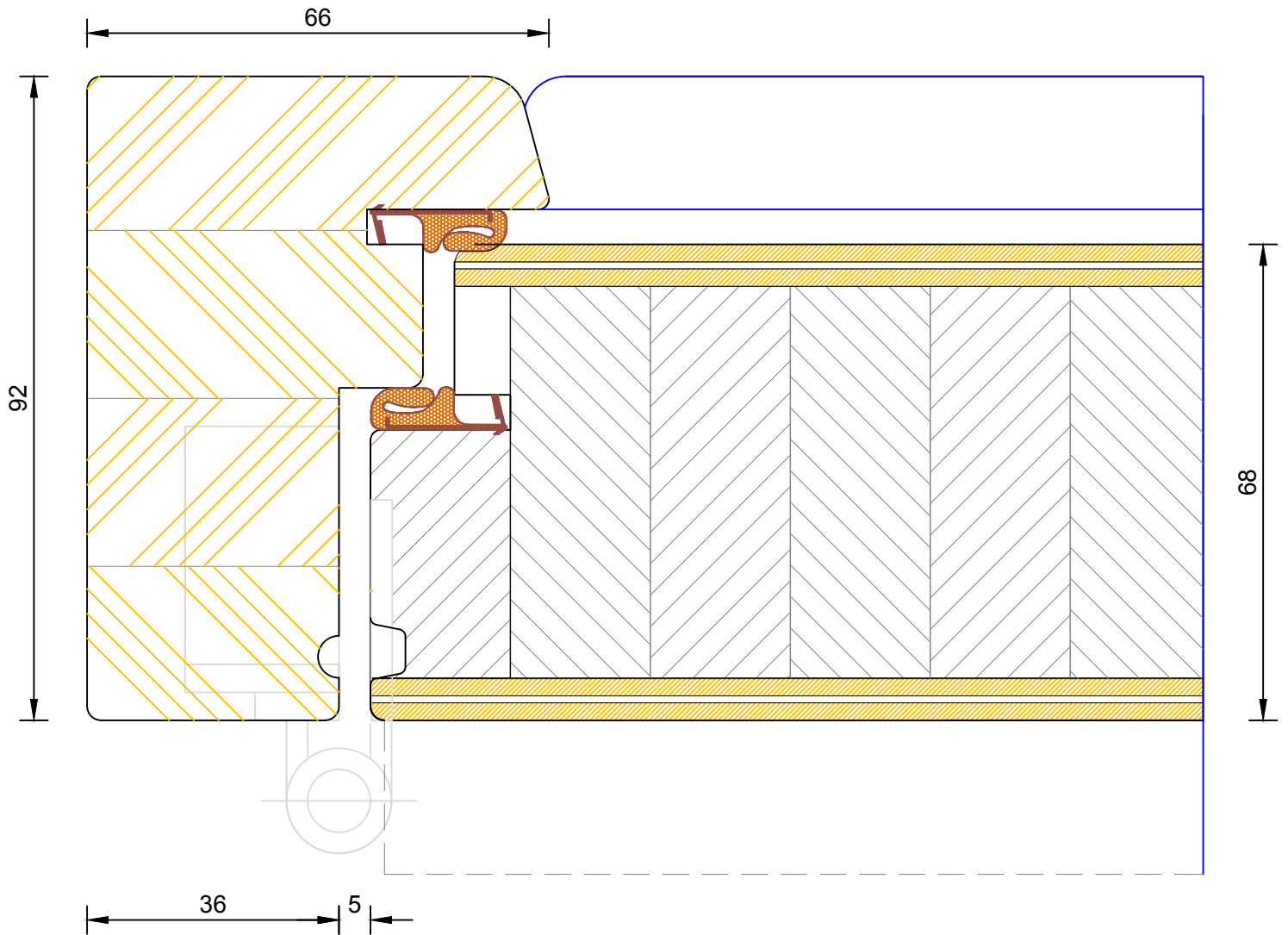

**Creative Open Out Flush Entrance Door
Frame & Leaf Jamb (Hinge Side)**

DIMENSIONS	PLOT SIZE	SCALE	DATE	REV	DWG NO.
MM	A4	1:1	19.04.2012	A	3510

Please consider the environment before printing

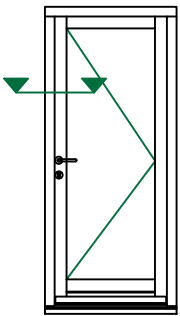
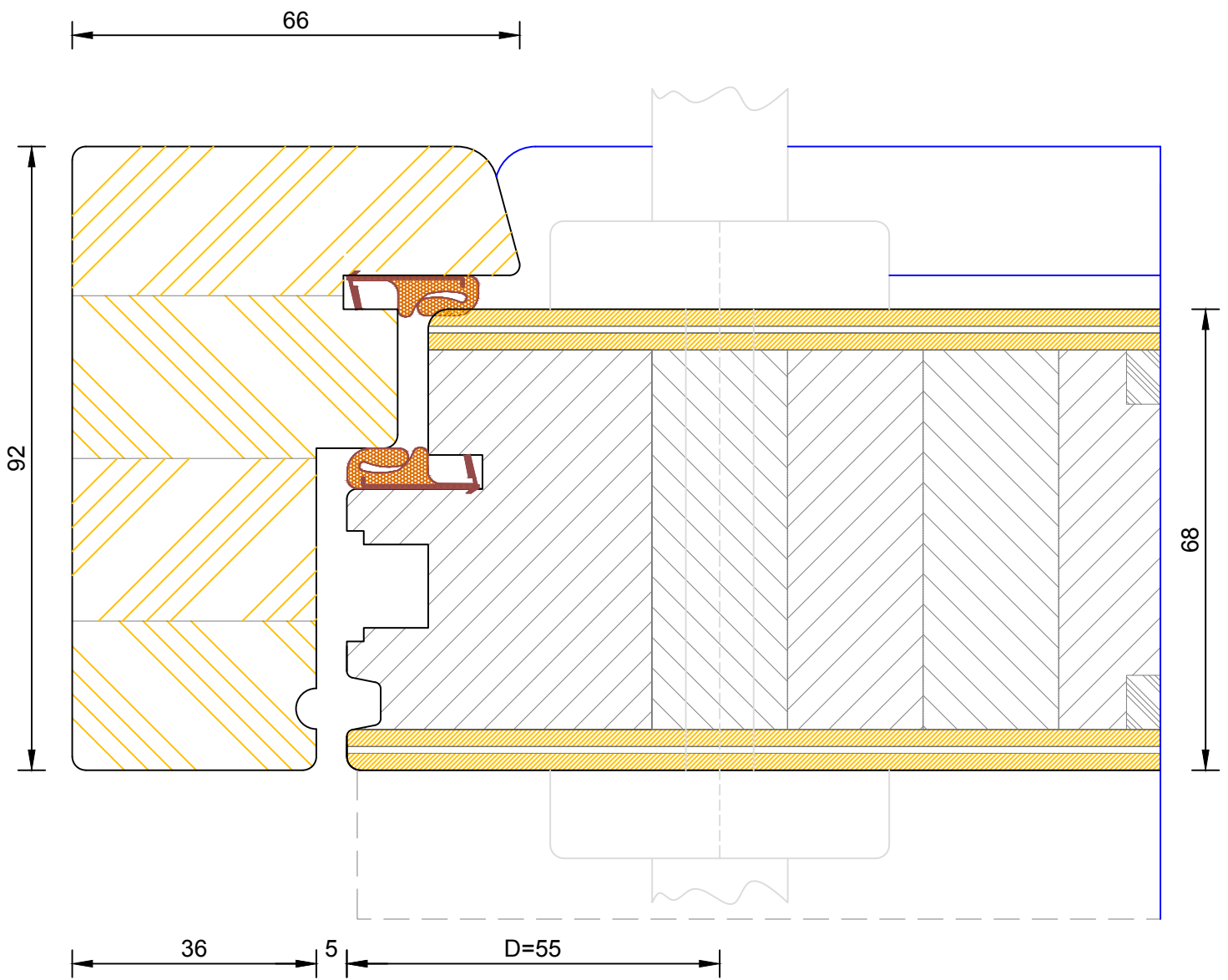

DIMENSIONS	PLOT SIZE	SCALE	DATE	REV	DWG NO.
MM	A4	1:1	19.04.2012	A	3511
Please consider the environment before printing					



Bereco

Creative Open Out Flush Entrance Door Flying Mullion

DIMENSIONS	PLOT SIZE	SCALE	DATE	REV	DWG. NO.
MM	A4	1:1	07.02.2011	A	3546

Please consider the environment before printing

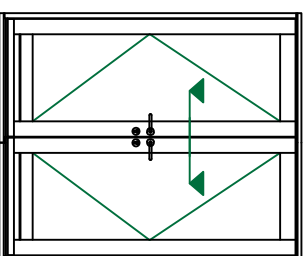
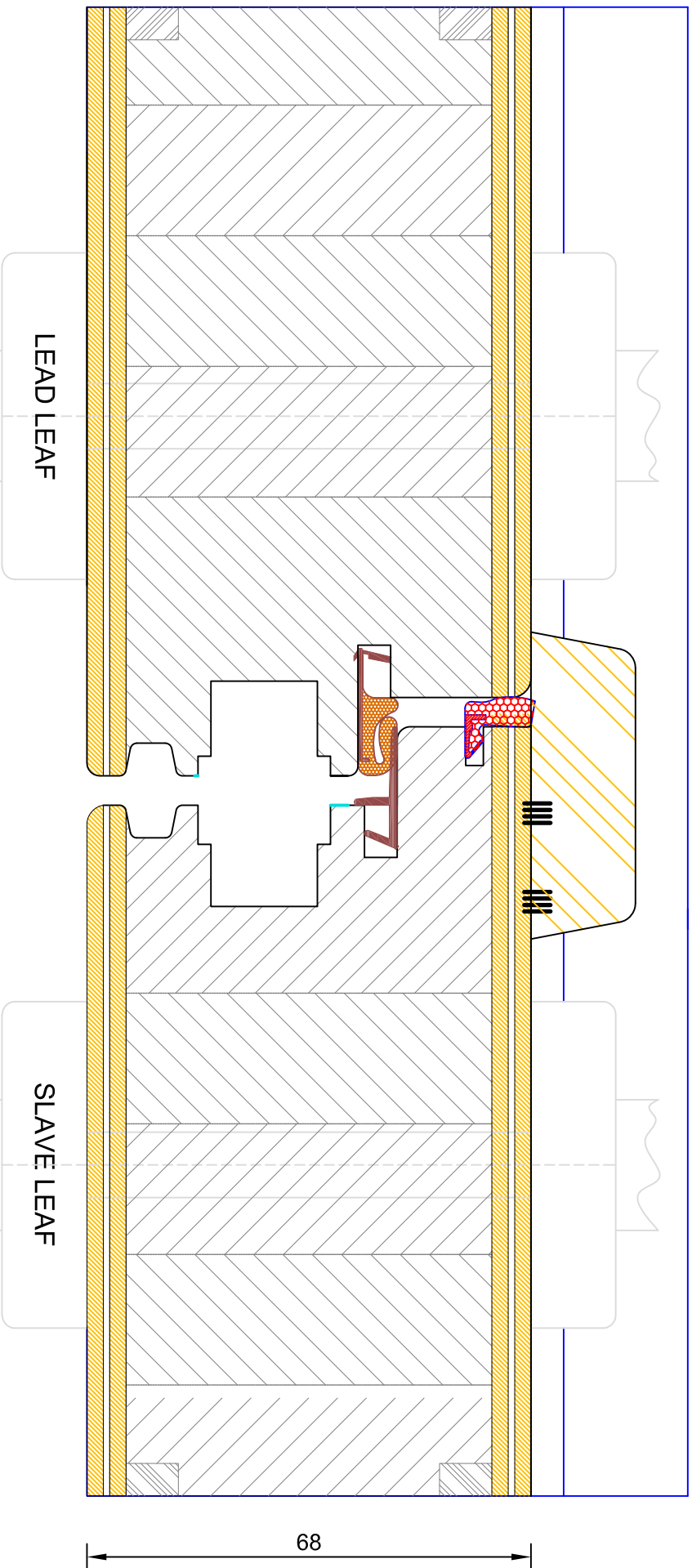

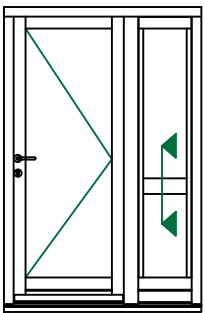
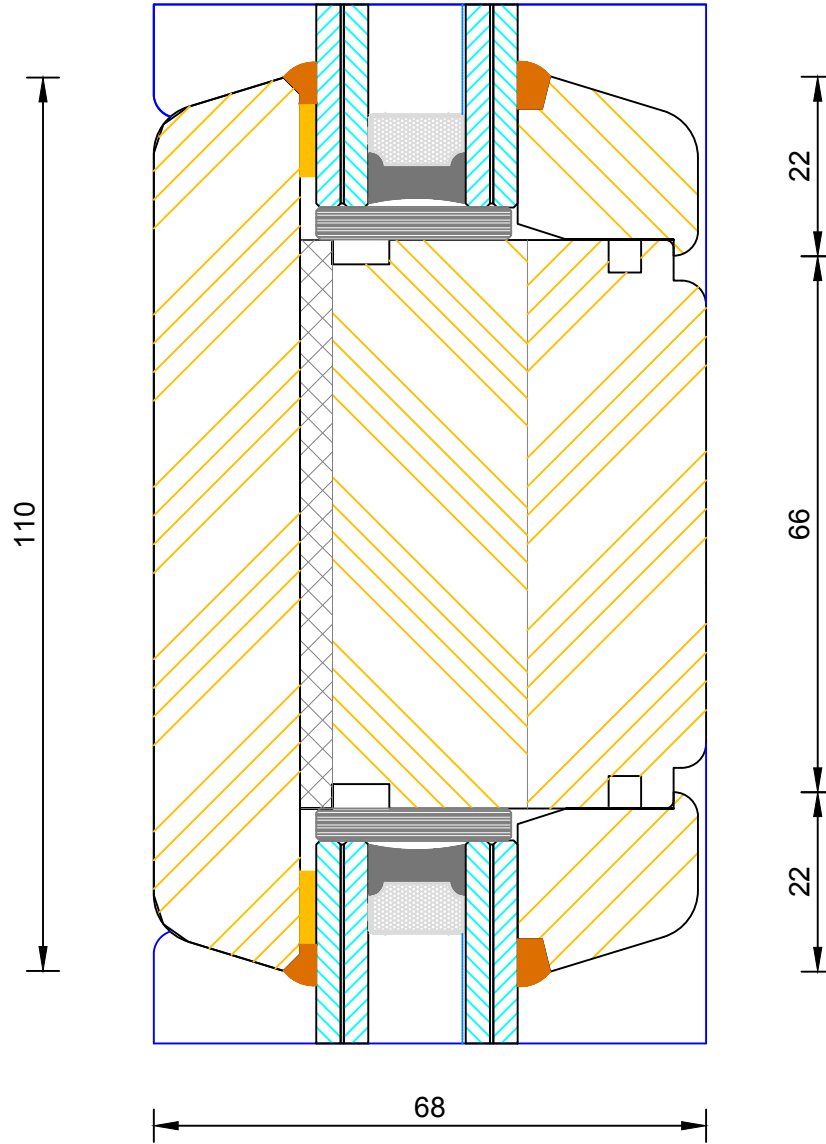

**Creative Open Out Flush Entrance Door
Mid Rail, Sidelight (110mm)**

DIMENSIONS	PLOT SIZE	SCALE	DATE	REV	DWG NO.
MM	A4	1:1	19.04.2012	A	3515
Please consider the environment before printing					

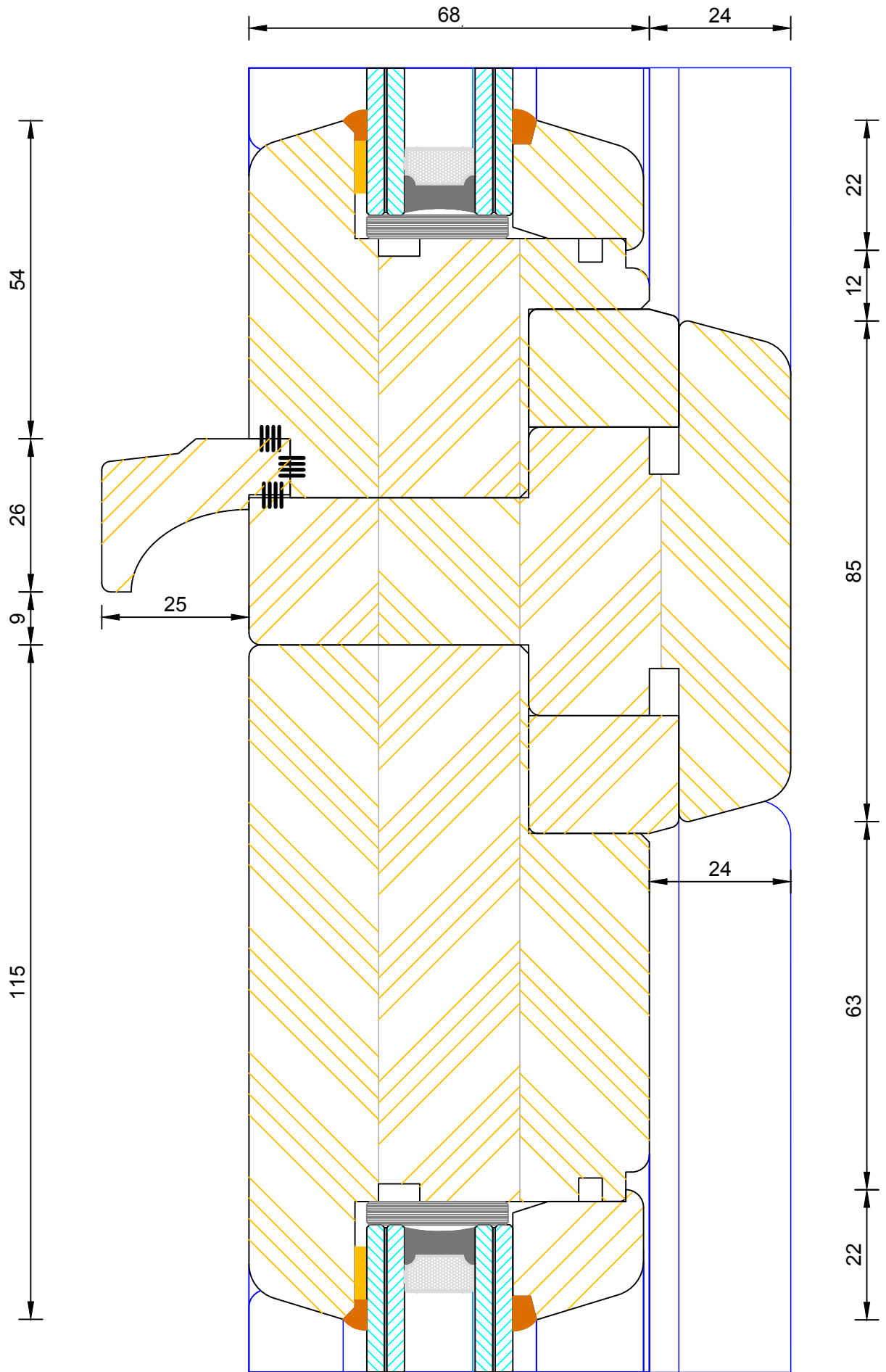
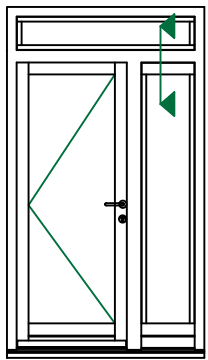

**Creative Open Out Flush Entrance Door
Solid Transom (Fanlight / Sidelight)**

DIMENSIONS	PLOT SIZE	SCALE	DATE	REV	DWG NO.
MM	A4	1:1	19.04.2012	A	3516

Please consider the environment before printing

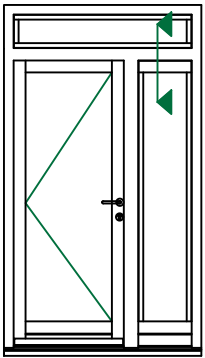
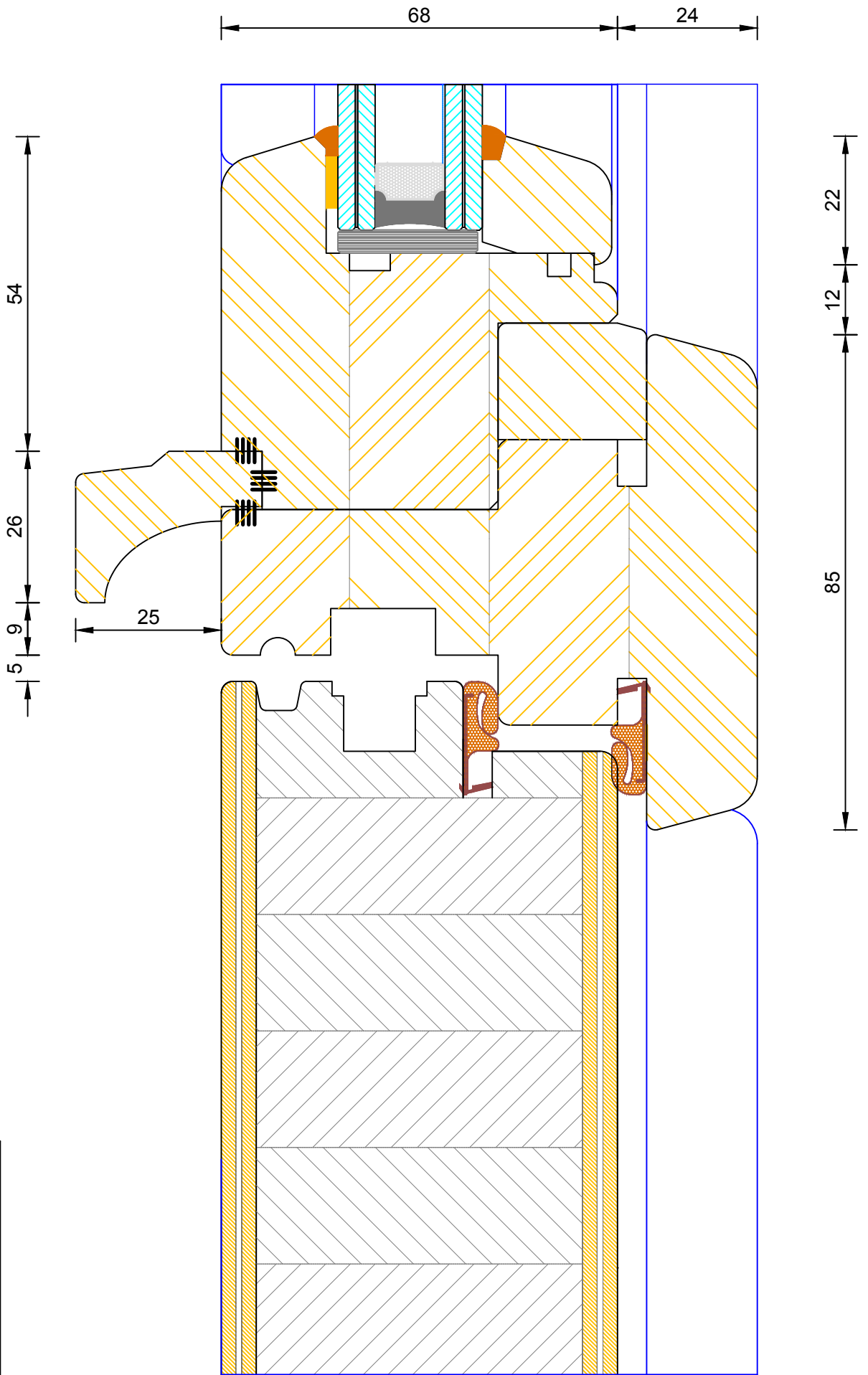

DIMENSIONS	PLOT SIZE	SCALE	DATE	REV	DWG NO.
MM	A4	1:1	19.04.2012	A	3517

22 | 12 | 100 | 12 | 22

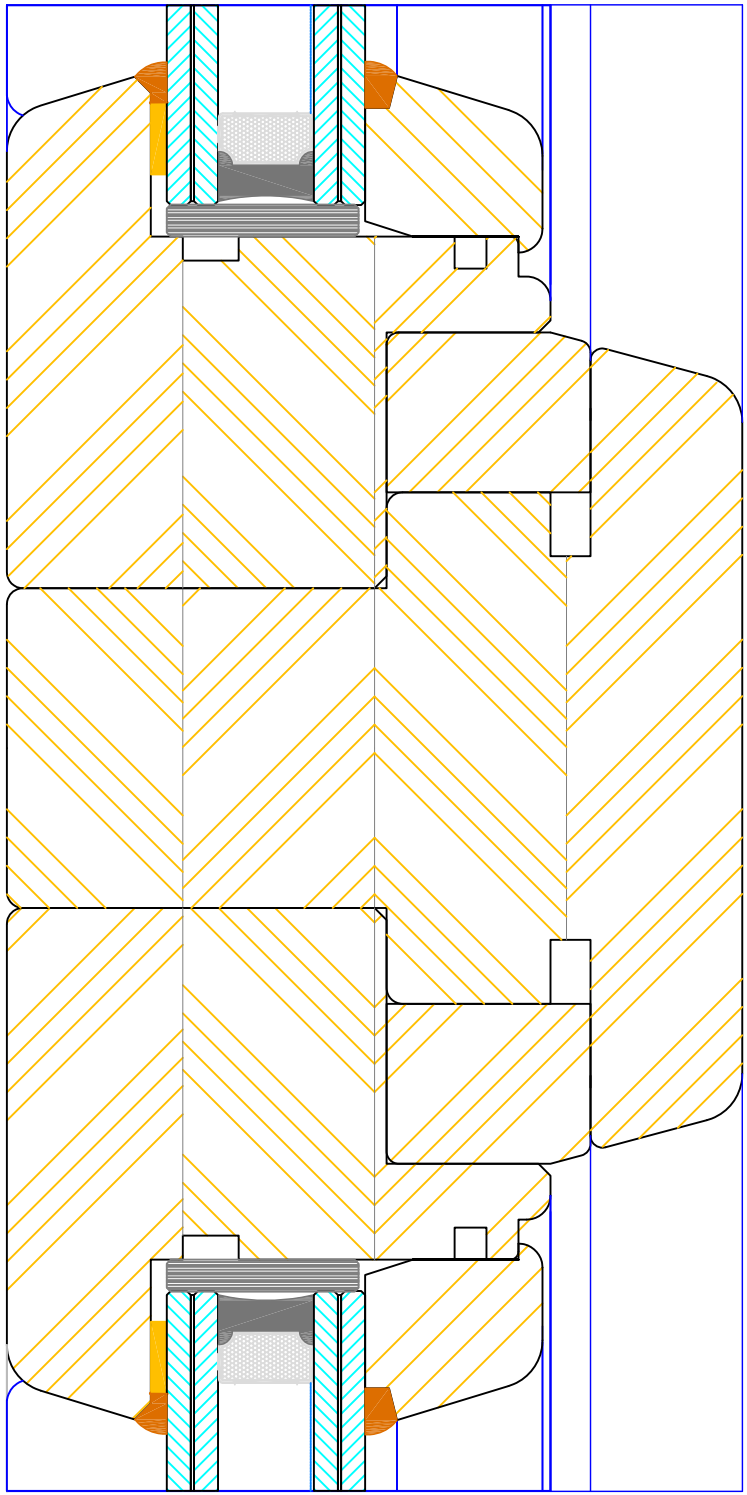

64 | 40 | 64

68 | 24



Bereco

Creative Open Out Flush Entrance Door
Solid Mullion (Fixed Light / Fixed Light)

DIMENSIONS	PLOT SIZE	SCALE	DATE	REV	DWG. NO.
MM	A4	1:1	19.04.2012	A	3518

Please consider the environment before printing

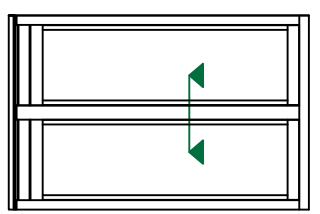

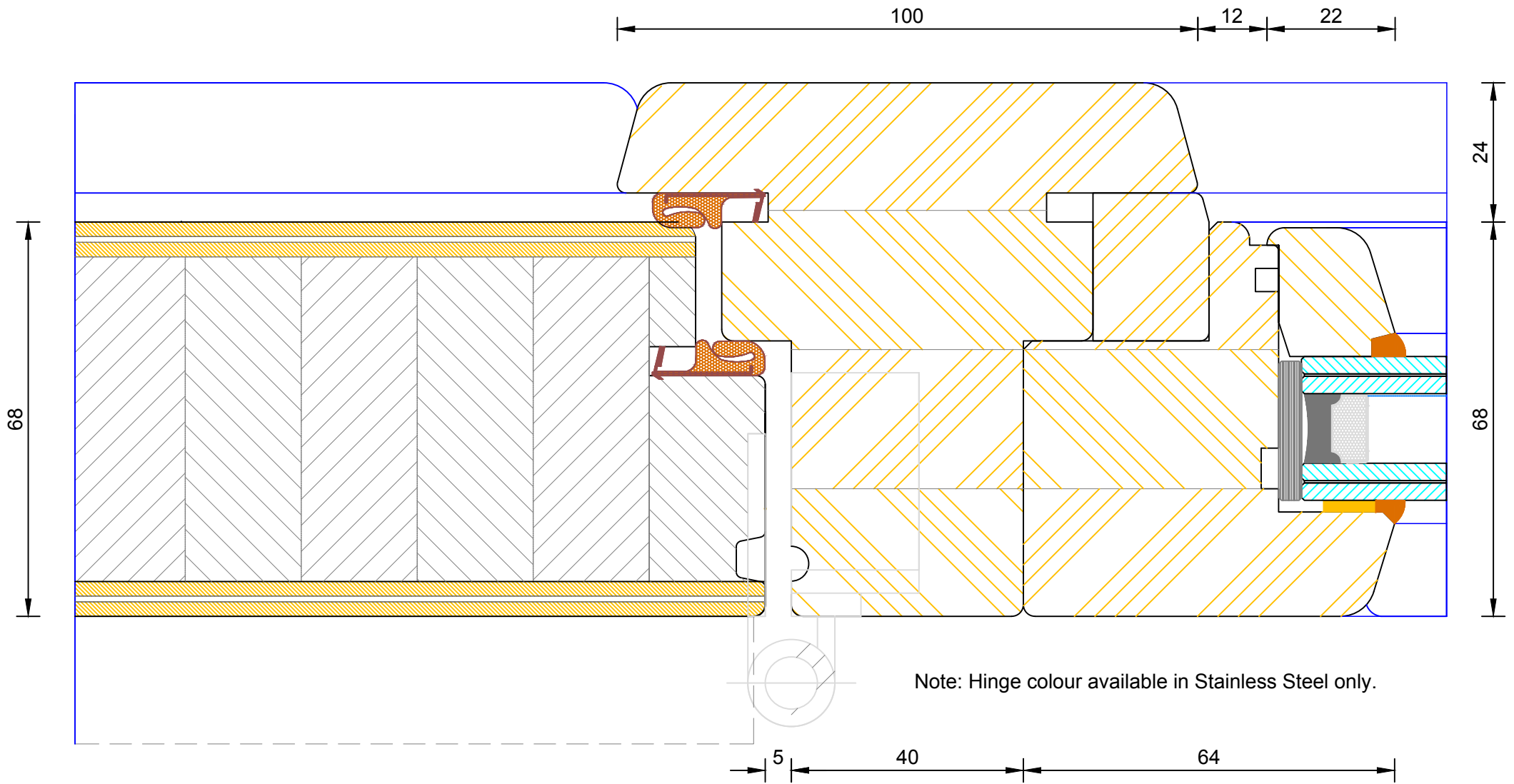

**Creative Open Out Flush Entrance Door
Solid Mullion (Leaf / Side Light)**

DIMENSIONS	PLOT SIZE	SCALE	DATE	REV	DWG NO.
MM	A4	1:1	19.04.2012	A	3519
Please consider the environment before printing					

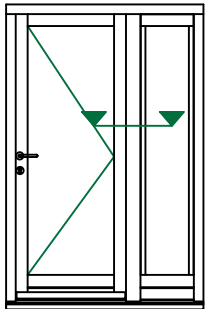



Bereco

Creative Open Out Flush Entrance Door Solid Mullion (Leaf / Side Light)

Please consider the environment before printing

DIMENSIONS	PLOT SIZE	SCALE	DATE	REV	DWG. NO.
MM	A4	1:1	19.04.2012	A	3520

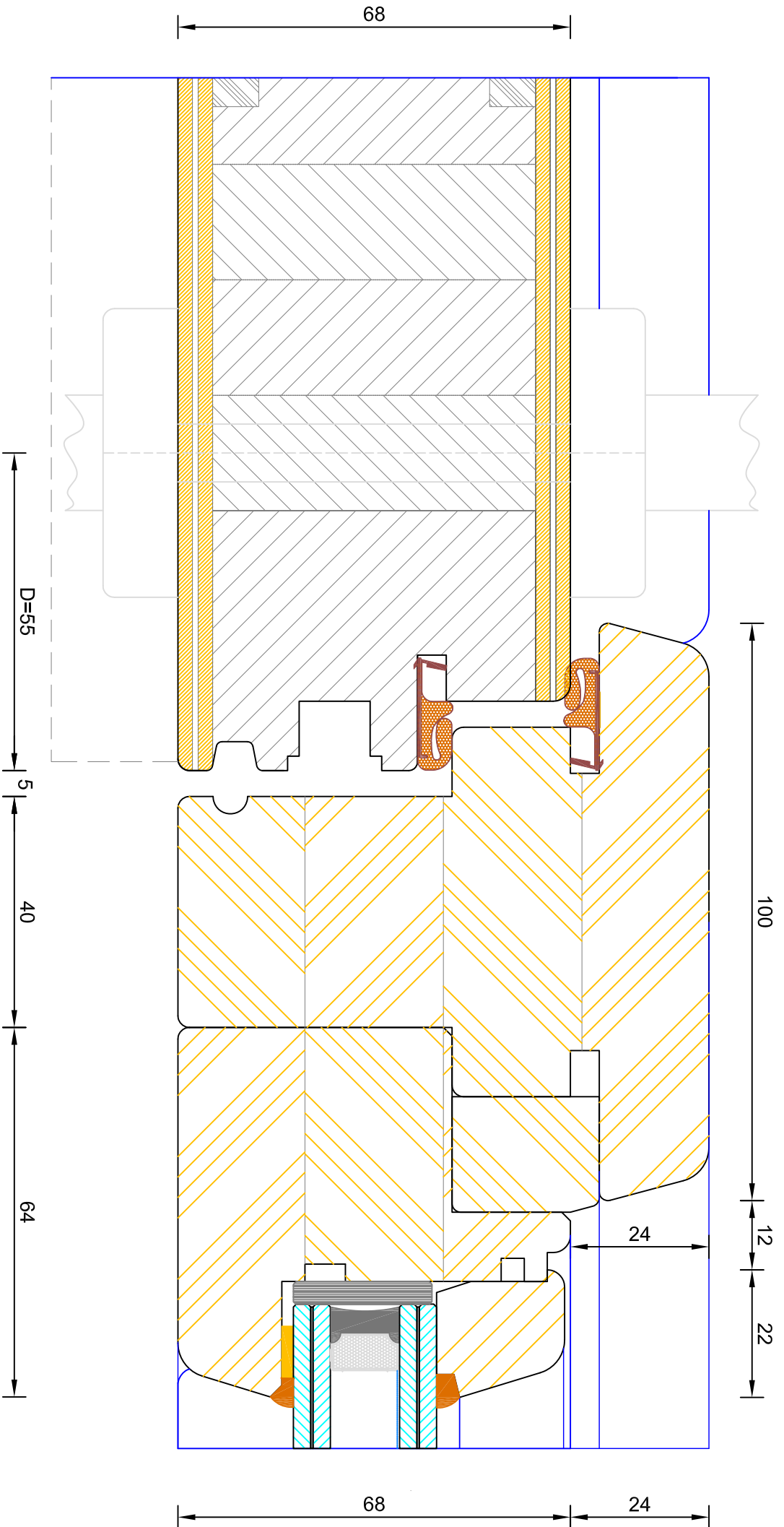
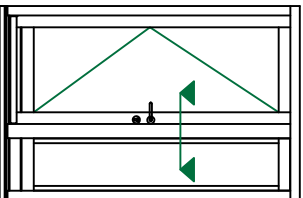

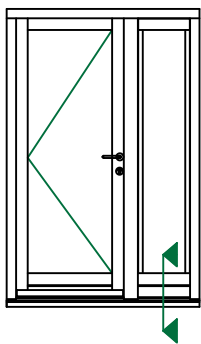
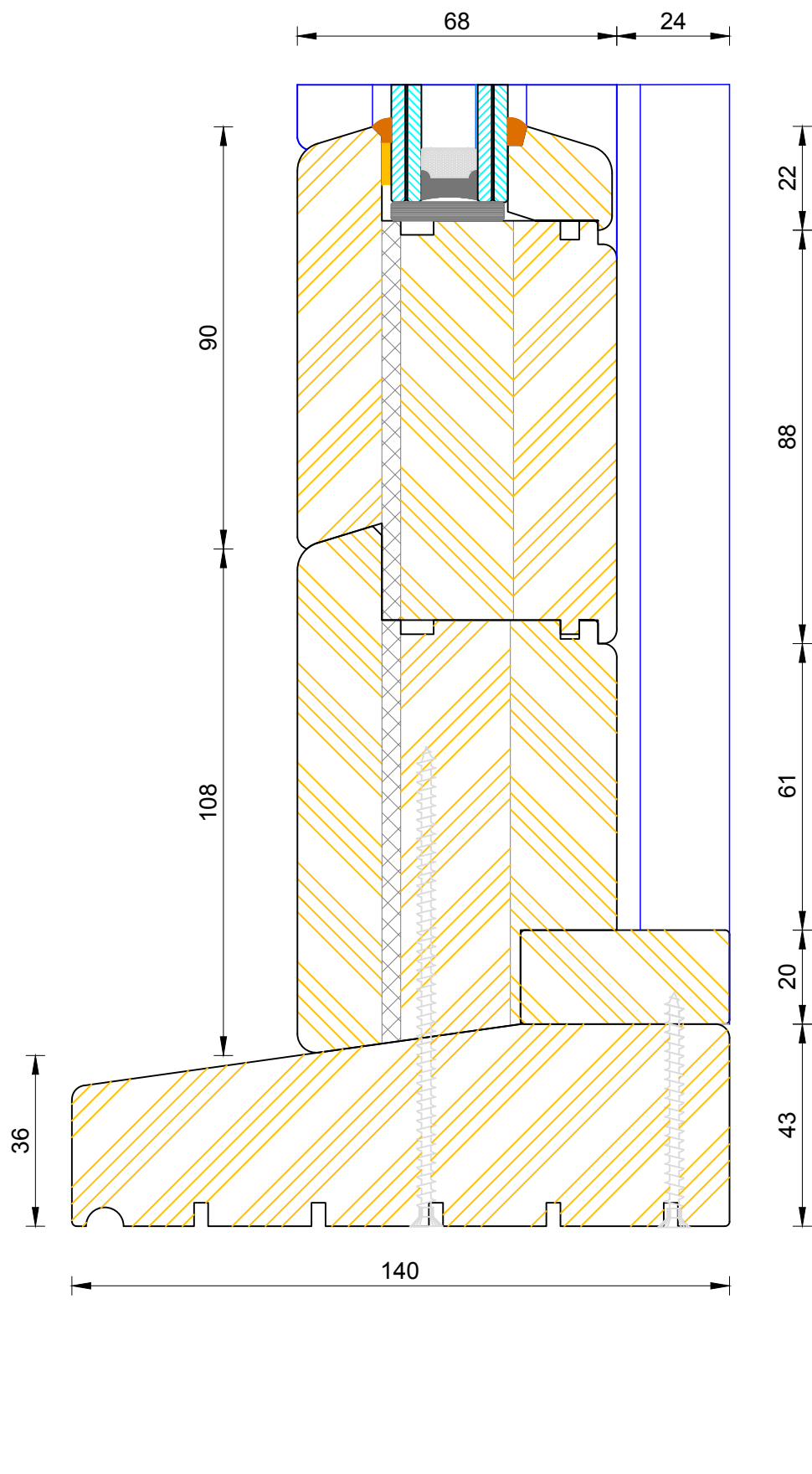

**Creative Open Out Flush Entrance Door
Standard Thresh (Sidelight)**

DIMENSIONS	PLOT SIZE	SCALE	DATE	REV	DWG NO.
MM	A3	1:1	19.04.2012	A	3506

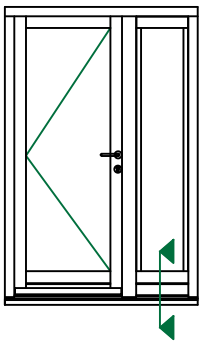
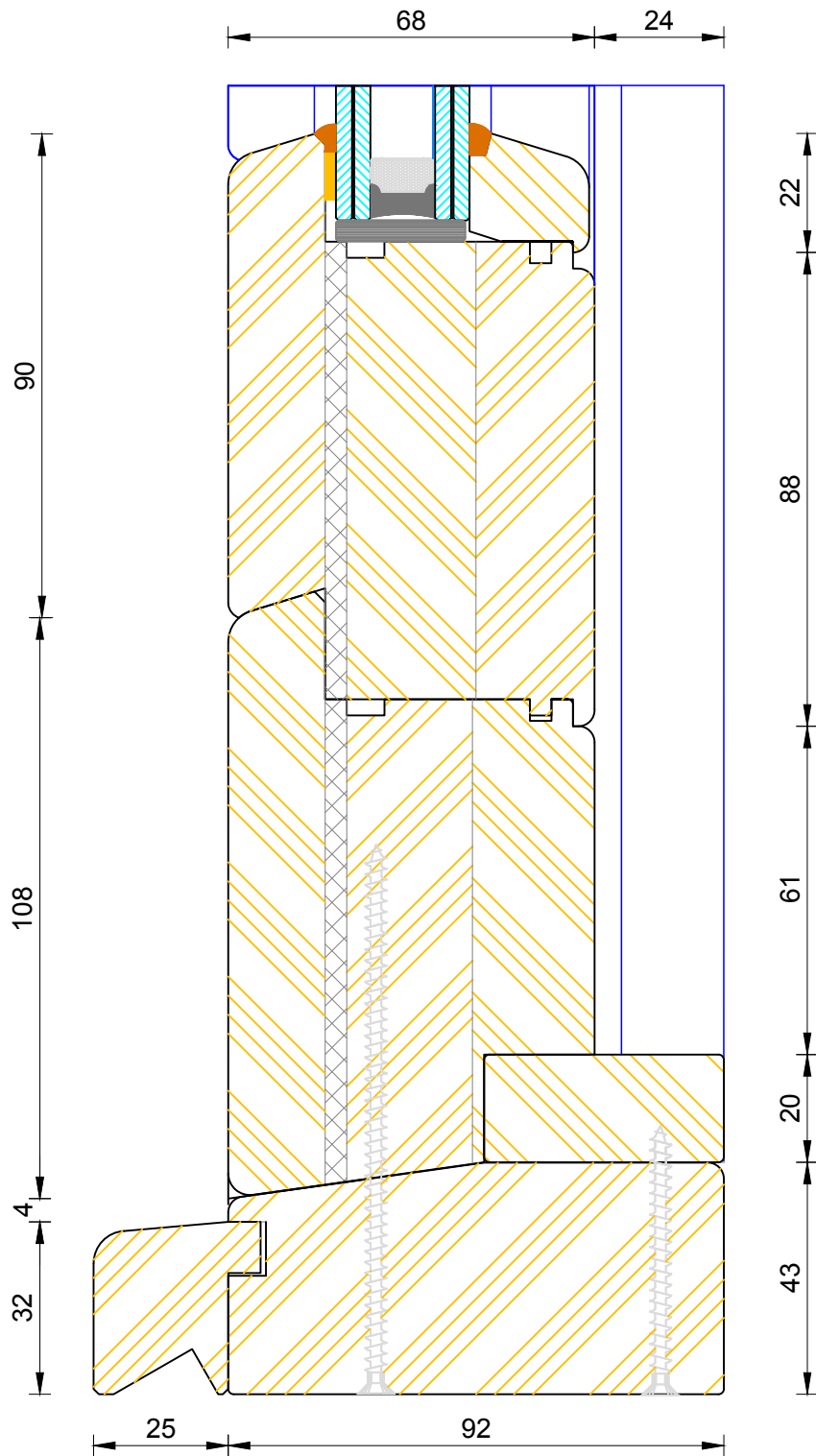

CILL EXTENSION - available options: 25mm (117mm o/a) / 47mm (139mm o/a) / 62mm (154mm o/a) / 87mm (179mm o/a) / 114mm (206mm o/a) / 125mm (217mm o/a) / 140mm (232mm o/a)

NOTE: Cill Extensions should be supported from underneath; the maximum overhang over Brick / Blockwork for cill extension should not exceed 25mm in order to avoid damage when stepped on. Warranties are invalidated when fitted with overhang in excess to that.

If not otherwise stated, Hardwood Threshold will be painted the same colour as Frame.



Creative Open Out Flush Entrance Door Coupling Thresh (Sidelight)

DIMENSIONS	PLOT SIZE	SCALE	DATE	REV	DWG NO.
MM	A3	1:1	19.04.2012	A	3507

Please consider the environment before printing

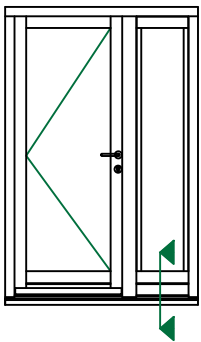
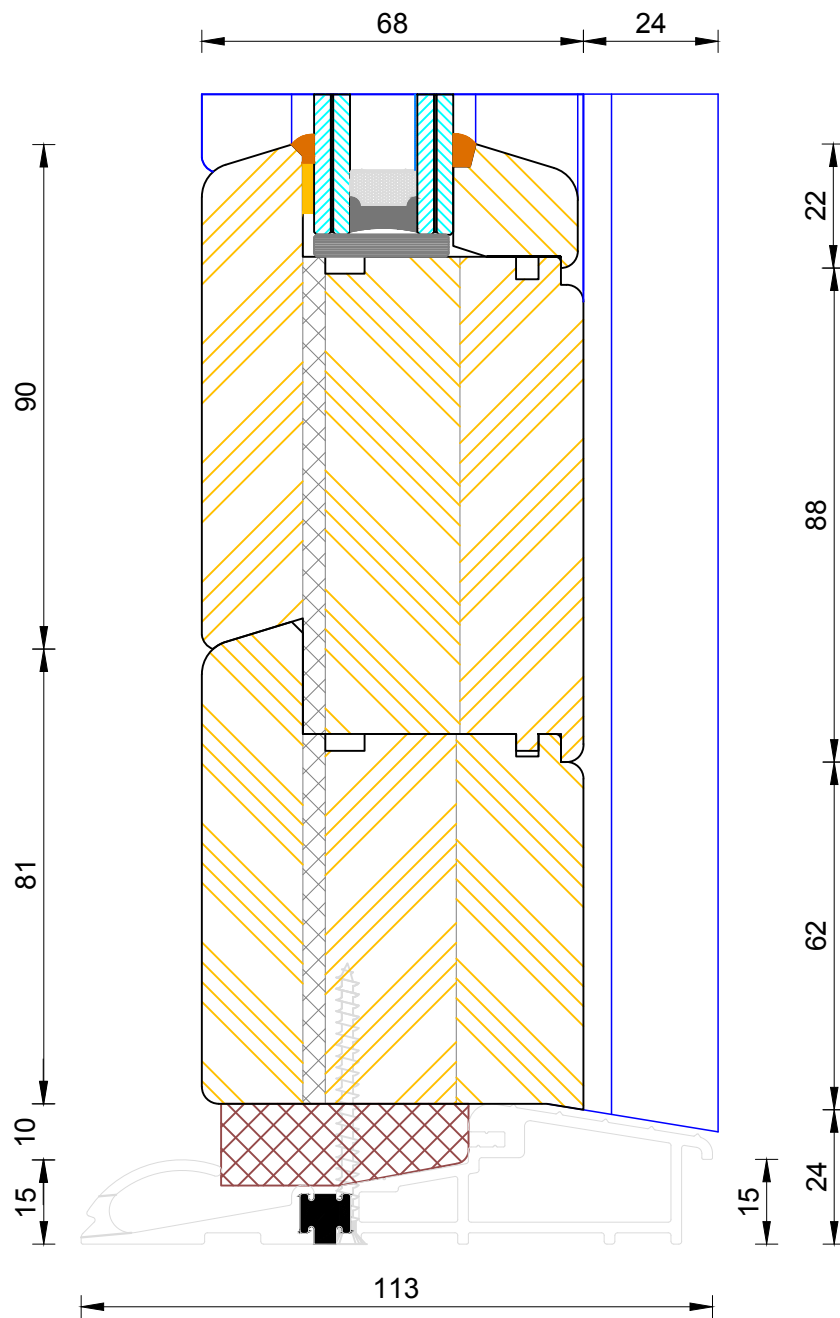

DIMENSIONS	PLOT SIZE	SCALE	DATE	REV	DWG NO.
MM	A3	1:1	19.04.2012	A	3508

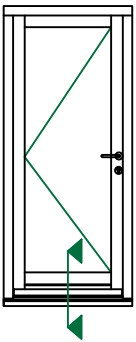
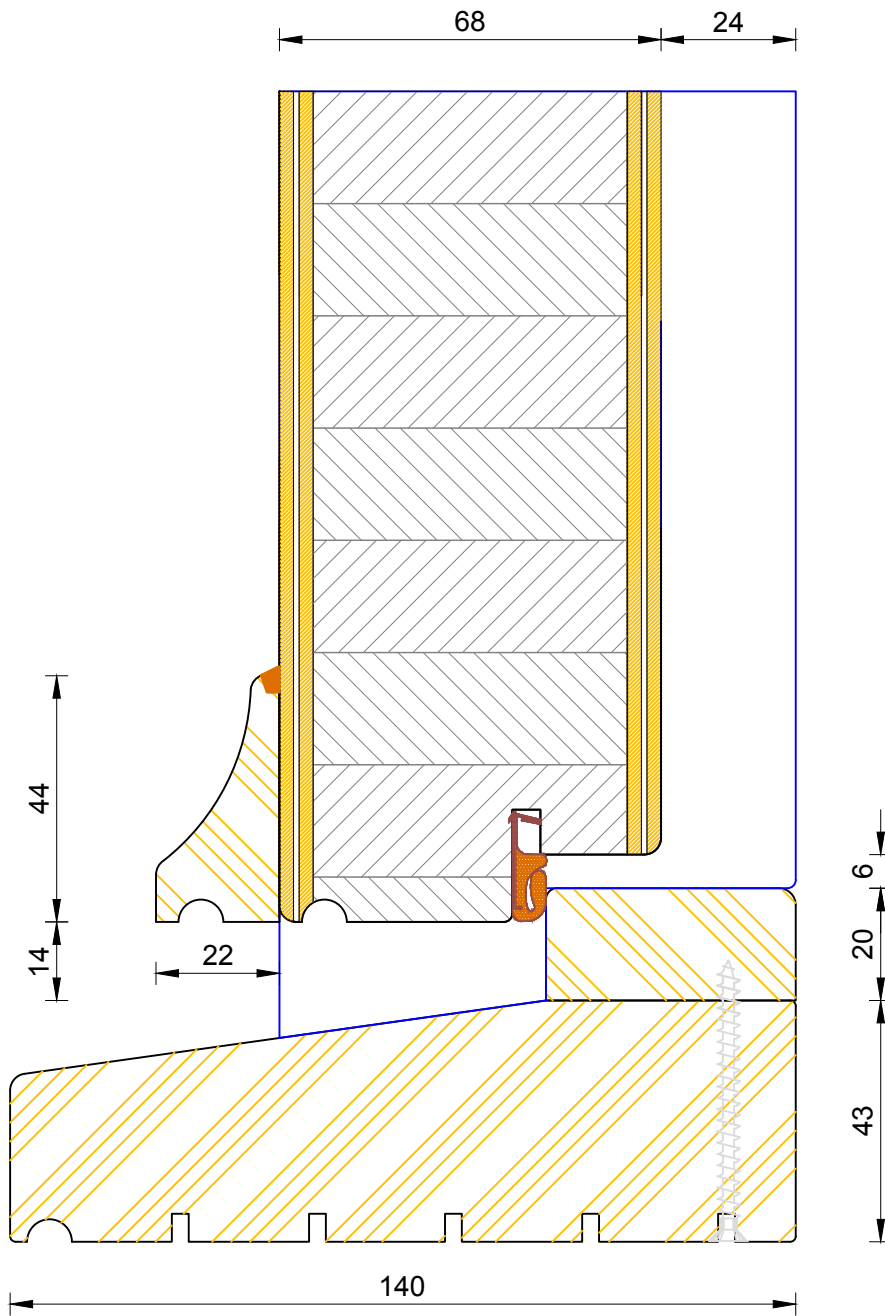

**Creative Open Out Flush Entrance Door
Standard Thresh (140x43mm)**

DIMENSIONS	PLOT SIZE	SCALE	DATE	REV	DWG NO.
MM	A3	1:1	19.04.2012	A	3512

Please consider the environment before printing

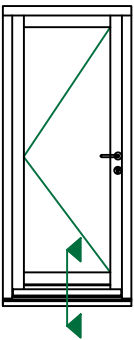
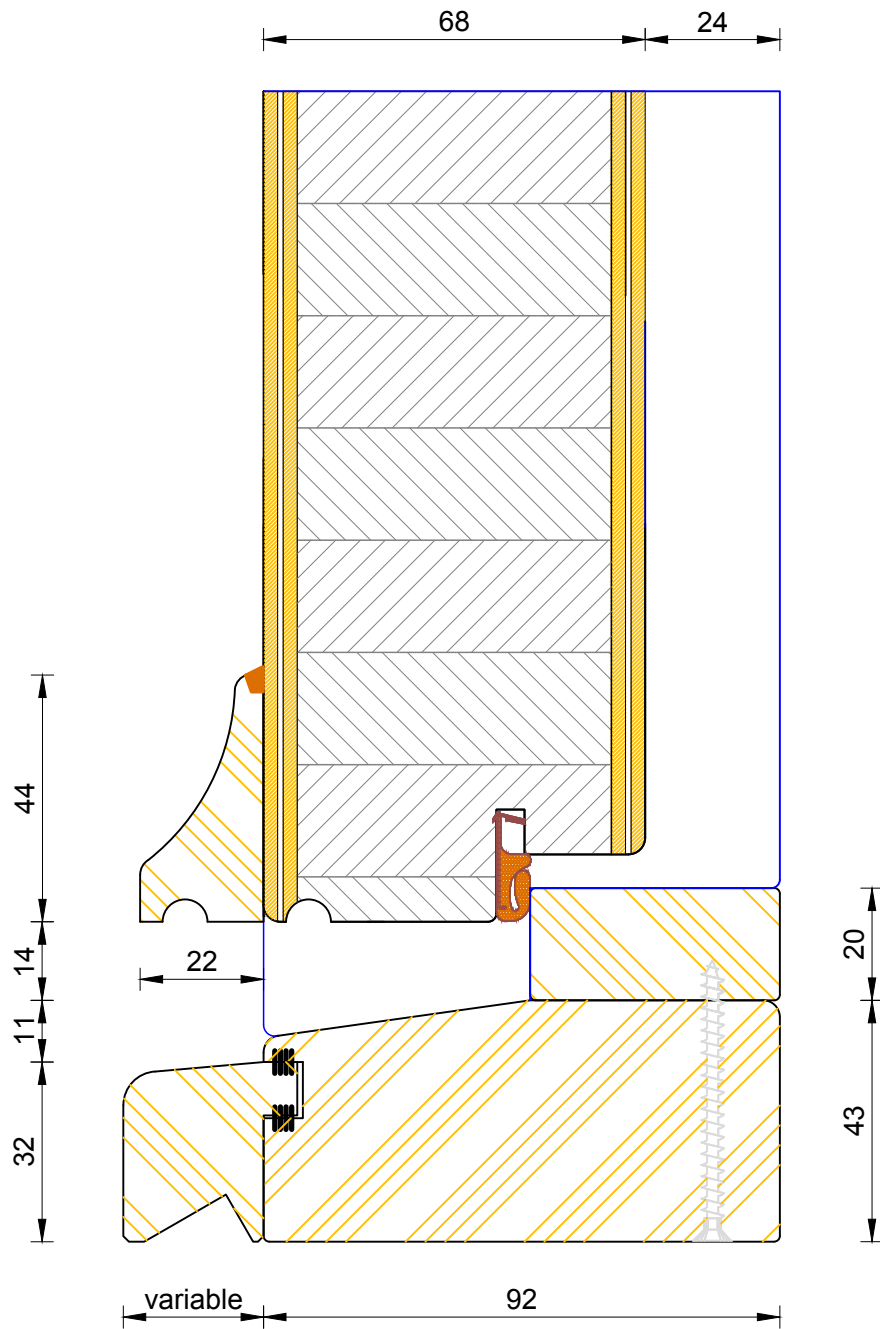

CILL EXTENSION - available options: 25mm (117mm o/a) / 47mm (139mm o/a) / 62mm (154mm o/a) / 87mm (179mm o/a) / 114mm (206mm o/a) / 125mm (217mm o/a) / 140mm (232mm o/a)

NOTE: Cill Extensions should be supported from underneath; the maximum overhang over Brick / Blockwork for cill extension should not exceed 25mm in order to avoid damage when stepped on. Warranties are invalidated when fitted with overhang in excess to that.

If not otherwise stated, Hardwood Threshold will be painted the same colour as Frame.

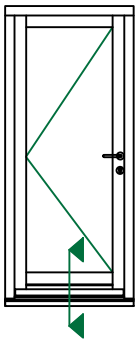
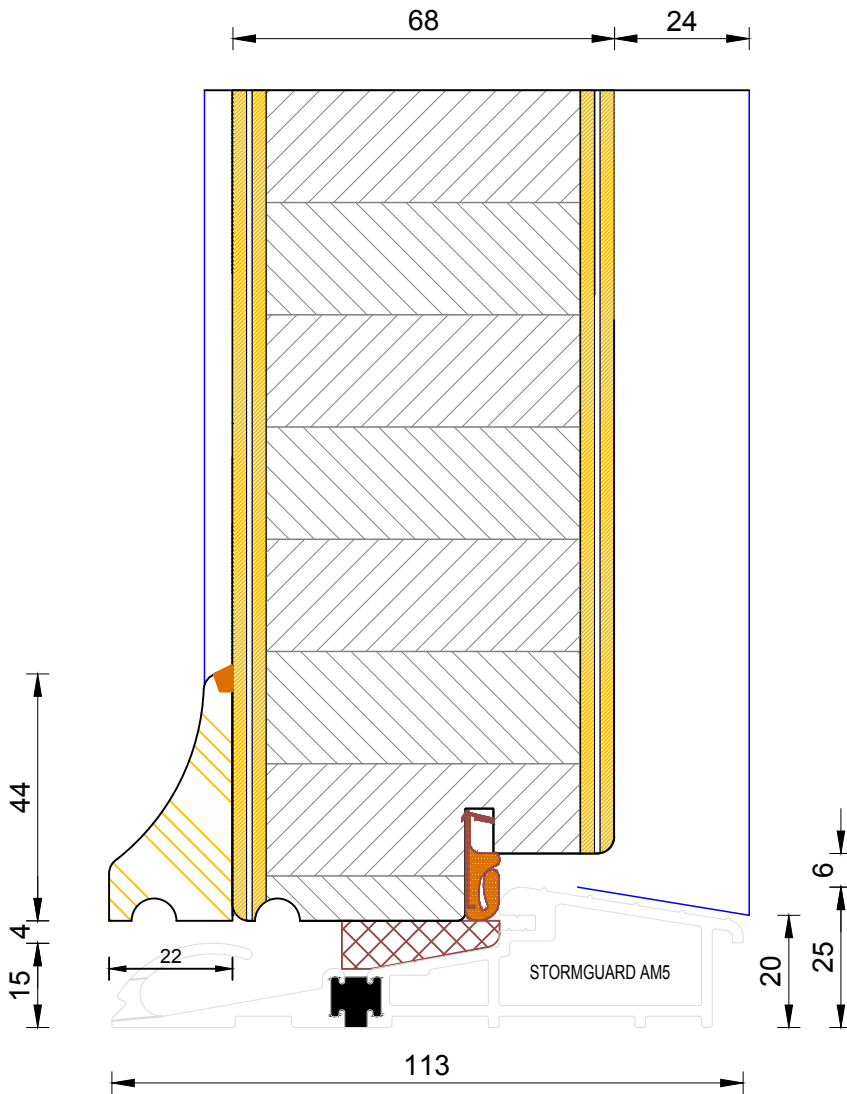

**Creative Open Out Flush Entrance Door
Mobility Thresh**

DIMENSIONS	PLOT SIZE	SCALE	DATE	REV	DWG NO.
MM	A3	1:1	19.04.2012	A	3514