

**Creative Open Out Flush Entrance Door**  
**Triple Glazed - Cill Extension Options**

DIMENSIONS	PLOT SIZE	SCALE	DATE	REV	DWG NO.
MM	A4	1:1	25.09.2019	B	<b>3551</b>

Please consider the environment before printing

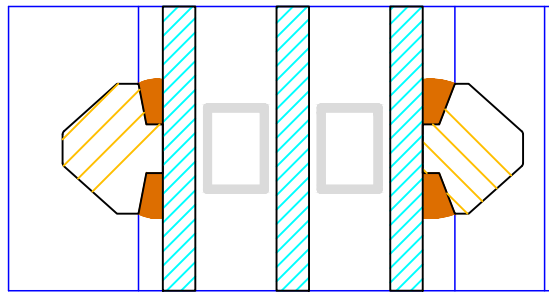

16

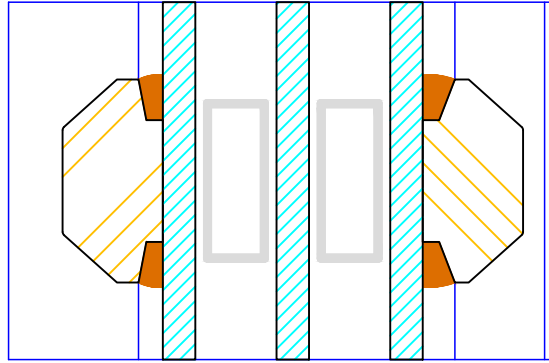

25

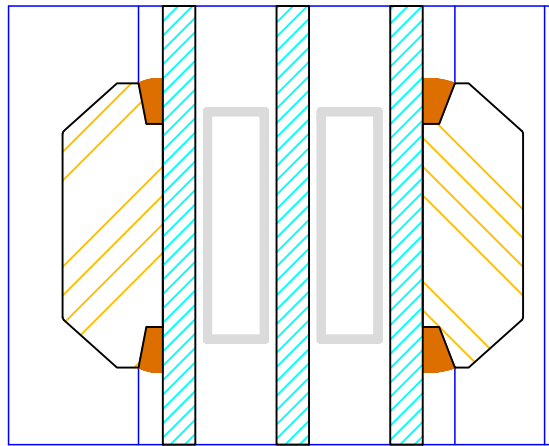

35

60 (varies min 60 / max 110mm)

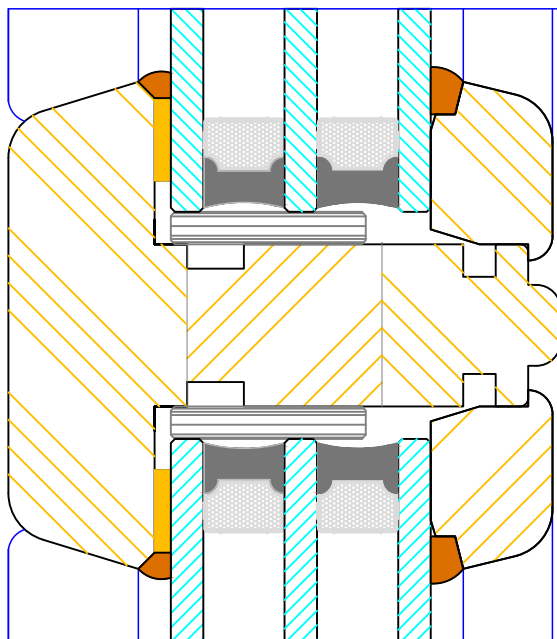

22  
16  
22

68

DIMENSIONS	PLOT SIZE	SCALE	DATE	REV	DWG NO.
MM	A4	1:1	19.04.2012	A	<b>3552</b>
Please consider the environment before printing					

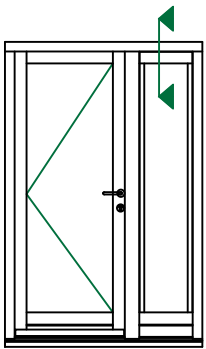
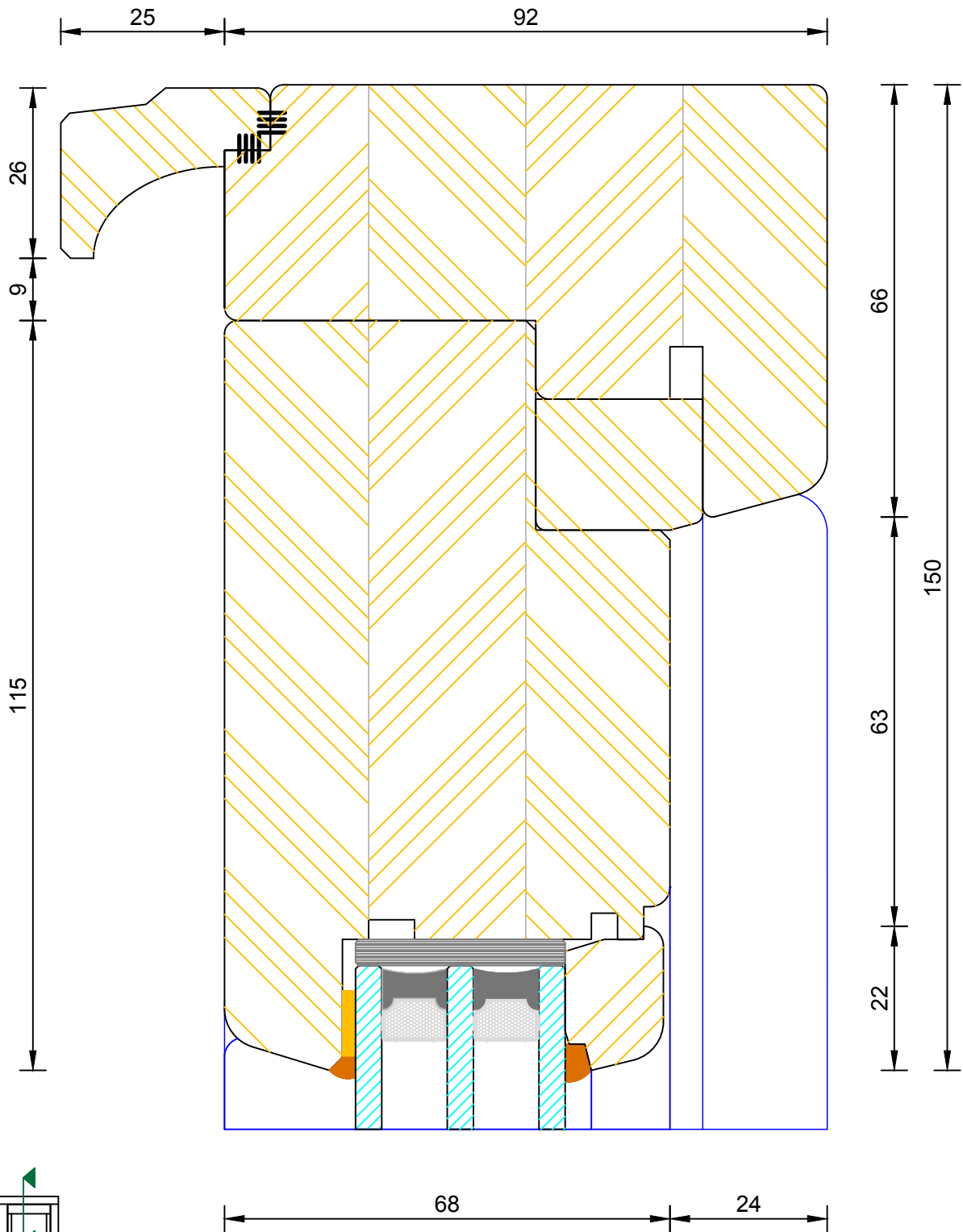

**Creative Open Out Flush Entrance Door**  
**Triple Glazed - Sidelight Head**

DIMENSIONS	PLOT SIZE	SCALE	DATE	REV	DWG NO.
MM	A4	1:1	19.04.2012	A	<b>3553</b>

Please consider the environment before printing

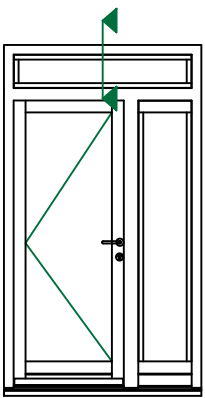
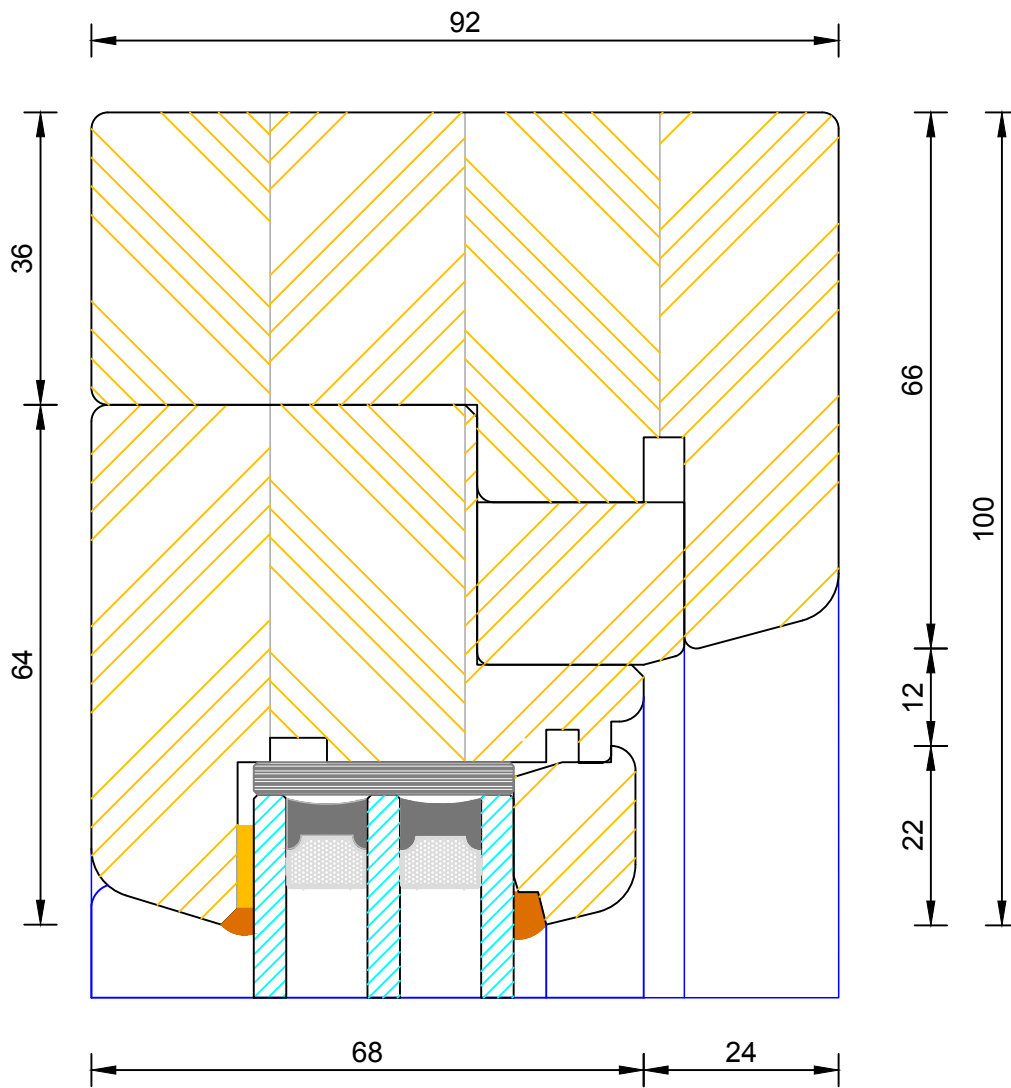

**Creative Open Out Flush Entrance Door**  
Triple Glazed - Fanlight Head

DIMENSIONS	PLOT SIZE	SCALE	DATE	REV	DWG NO.
MM	A4	1:1	19.04.2012	A	<b>3554</b>

Please consider the environment before printing

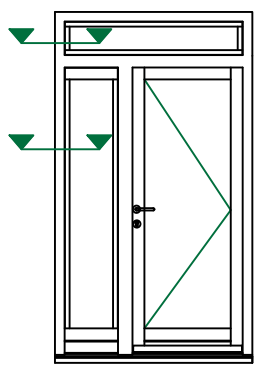
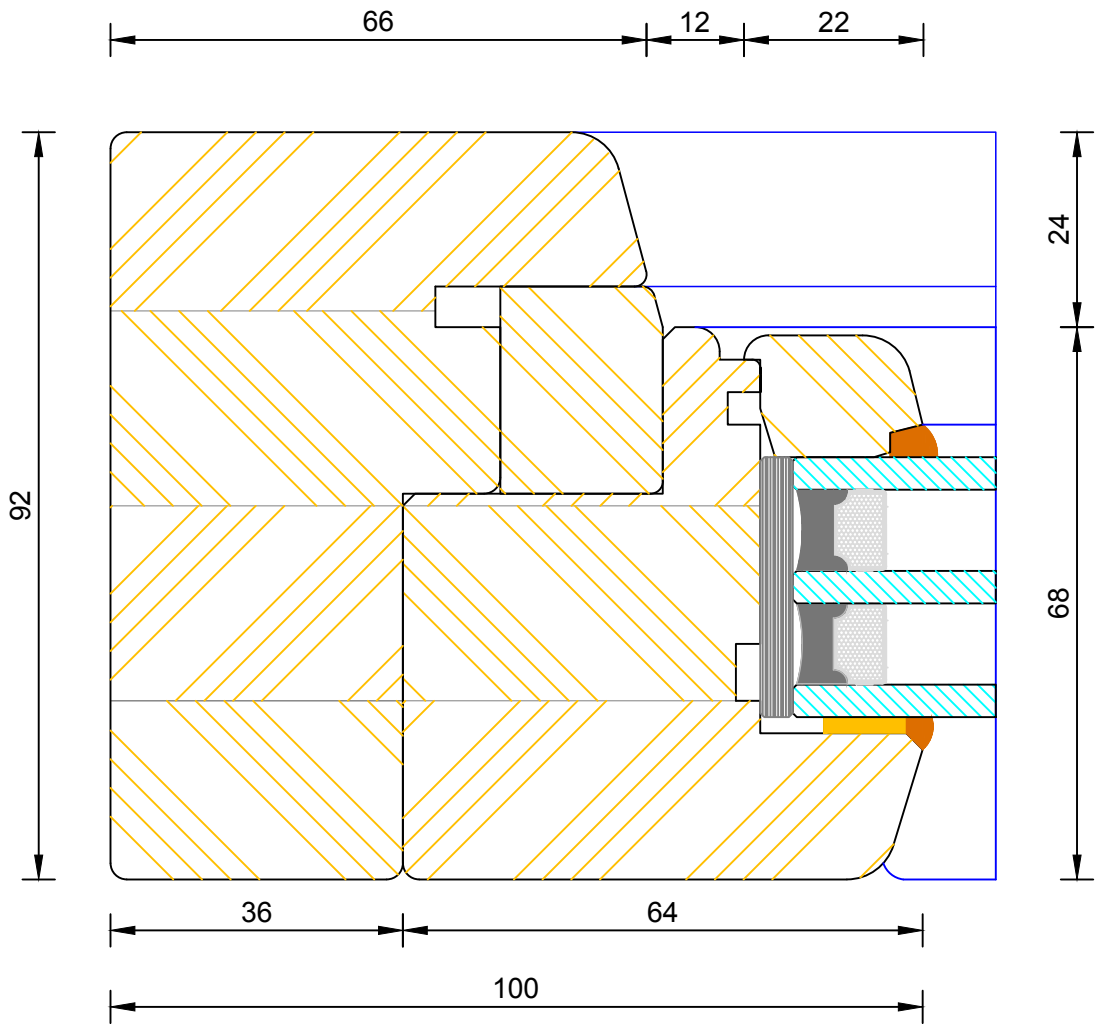

DIMENSIONS	PLOT SIZE	SCALE	DATE	REV	DWG NO.
MM	A4	1:1	19.04.2012	A	<b>3555</b>

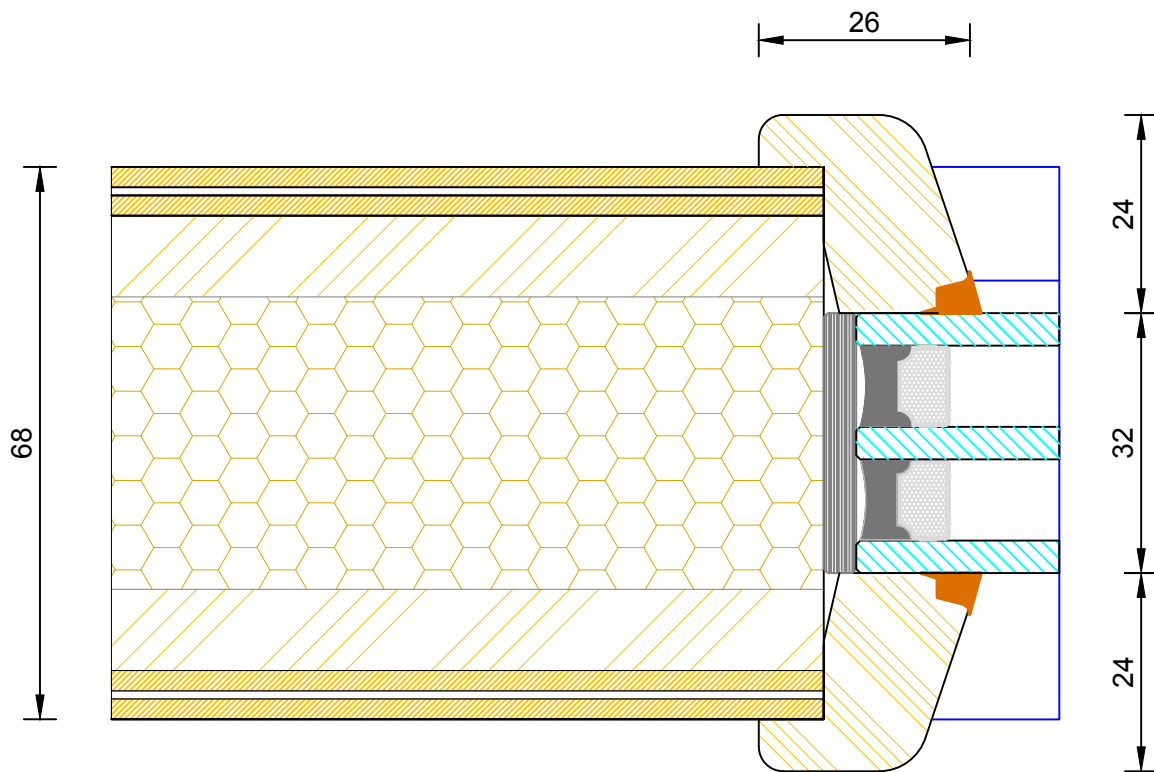

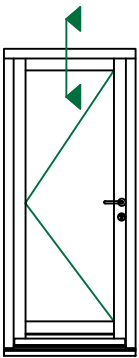
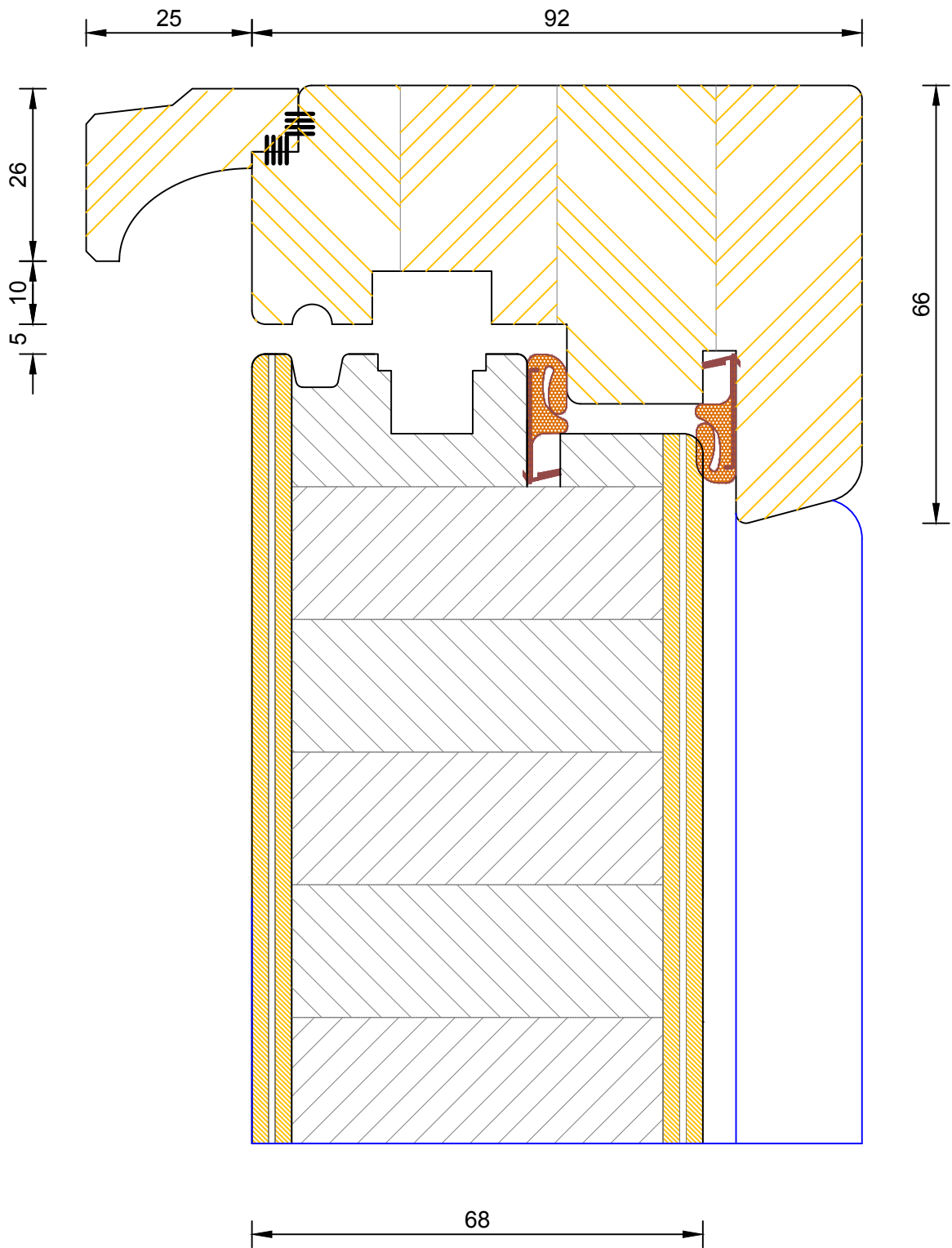

**Creative Open Out Flush Entrance Door**  
 Triple Glazed - Frame & Leaf Head

DIMENSIONS	PLOT SIZE	SCALE	DATE	REV	DWG NO.
MM	A4	1:1	19.04.2012	A	<b>3560</b>

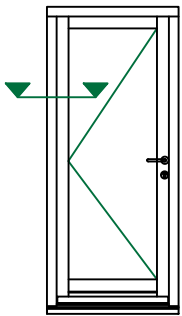
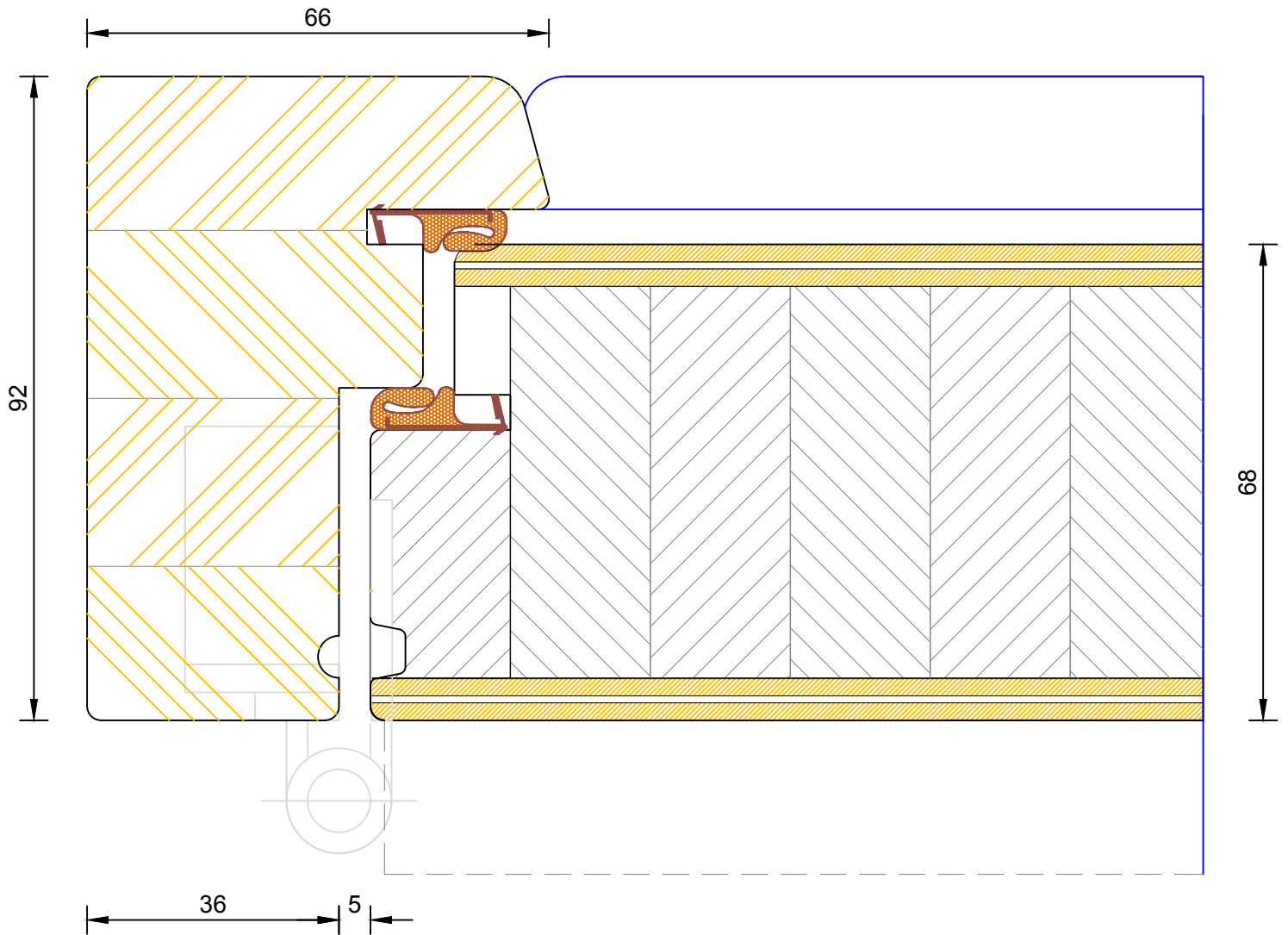

**Creative Open Out Flush Entrance Door**  
Triple Glazed - Frame & Leaf Jamb (Hinge Side)

DIMENSIONS	PLOT SIZE	SCALE	DATE	REV	DWG NO.
MM	A4	1:1	19.04.2012	A	<b>3561</b>

Please consider the environment before printing



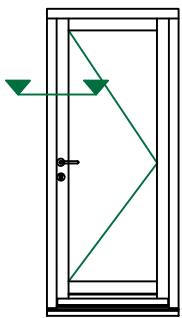
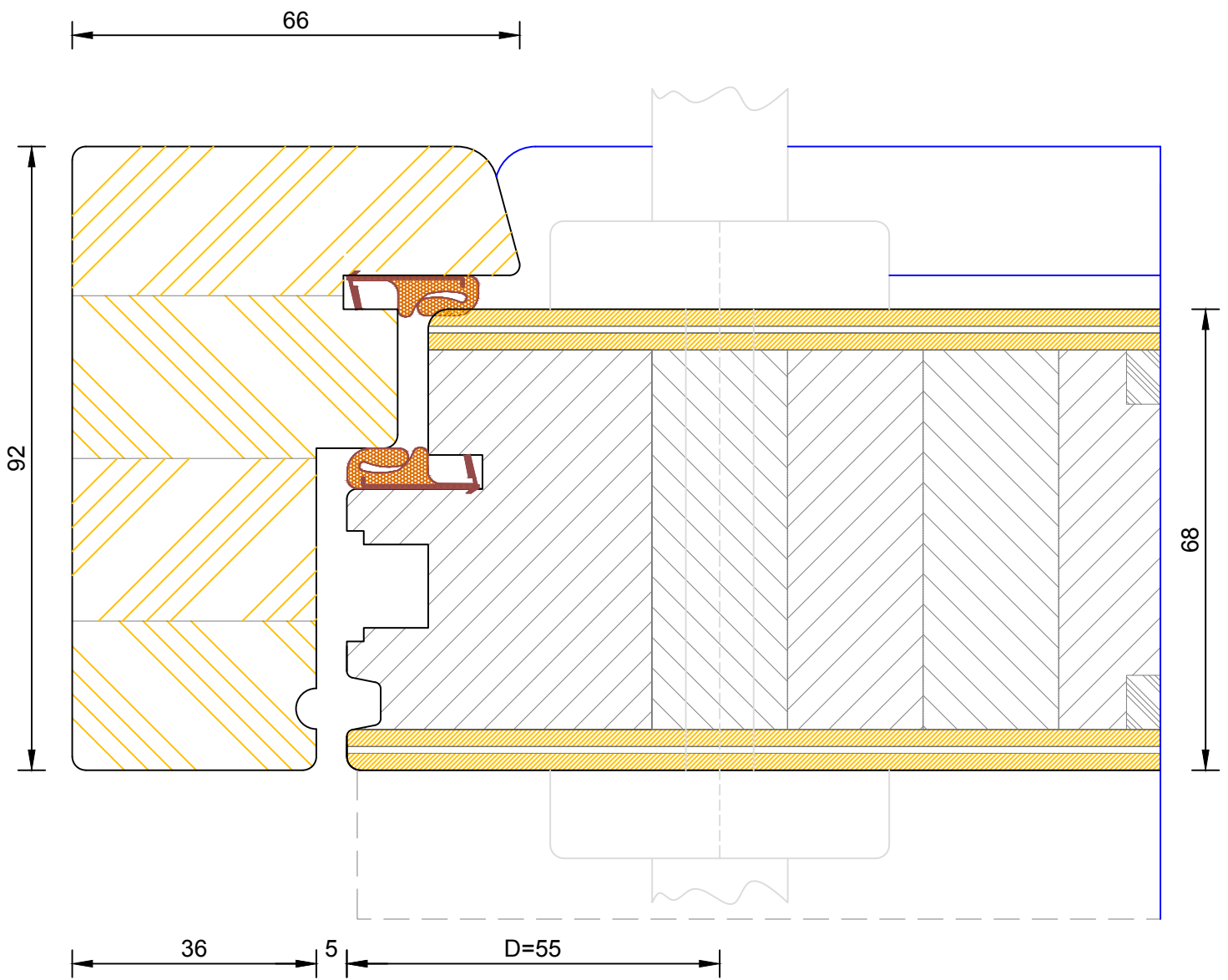

DIMENSIONS	PLOT SIZE	SCALE	DATE	REV	DWG NO.
MM	A4	1:1	19.04.2012	A	<b>3562</b>
Please consider the environment before printing					



# Bereco

## Creative Open Out Flush Entrance Door Triple Glazed - Flying Mullion

DIMENSIONS	PLOT SIZE	SCALE	DATE	REV	DWG. NO.
MM	A4	1:1	07.02.2011	A	<b>3563</b>

Please consider the environment before printing

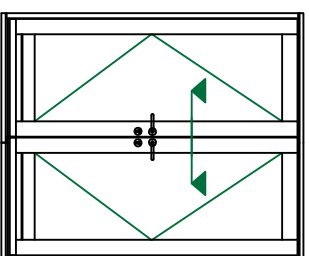
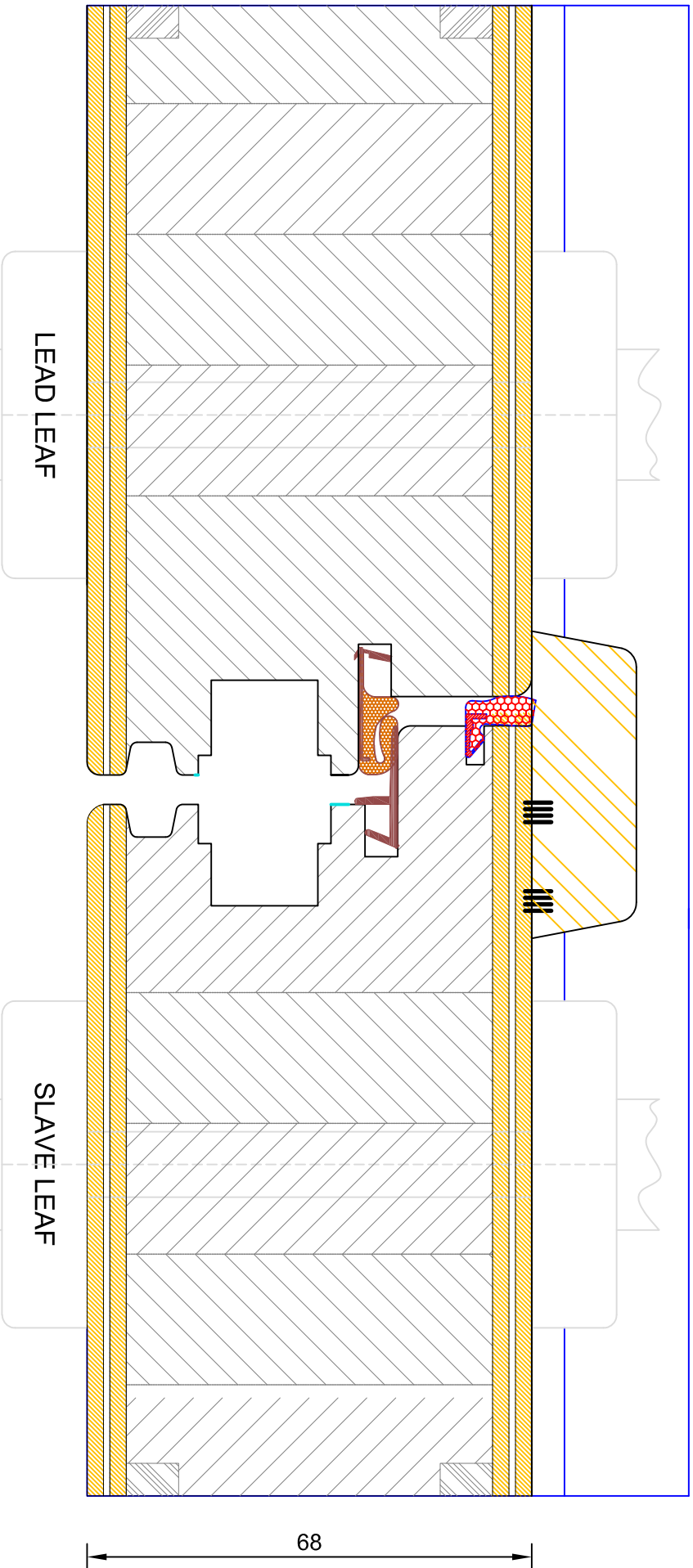

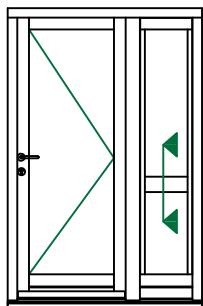
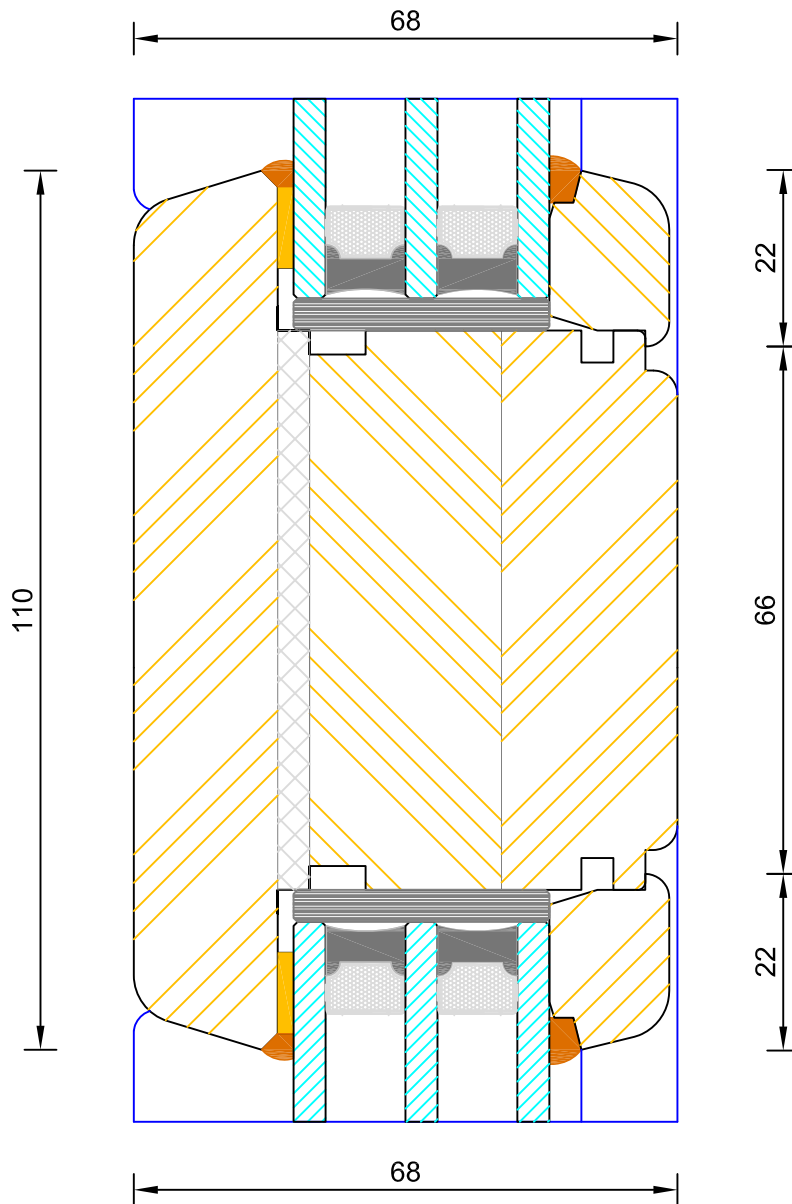

**Creative Open Out Flush Entrance Door**  
**Triple Glazed - Mid Rail, Sidelight (110mm)**

DIMENSIONS	PLOT SIZE	SCALE	DATE	REV	DWG NO.
MM	A4	1:1	19.04.2012	A	<b>3567</b>
Please consider the environment before printing					

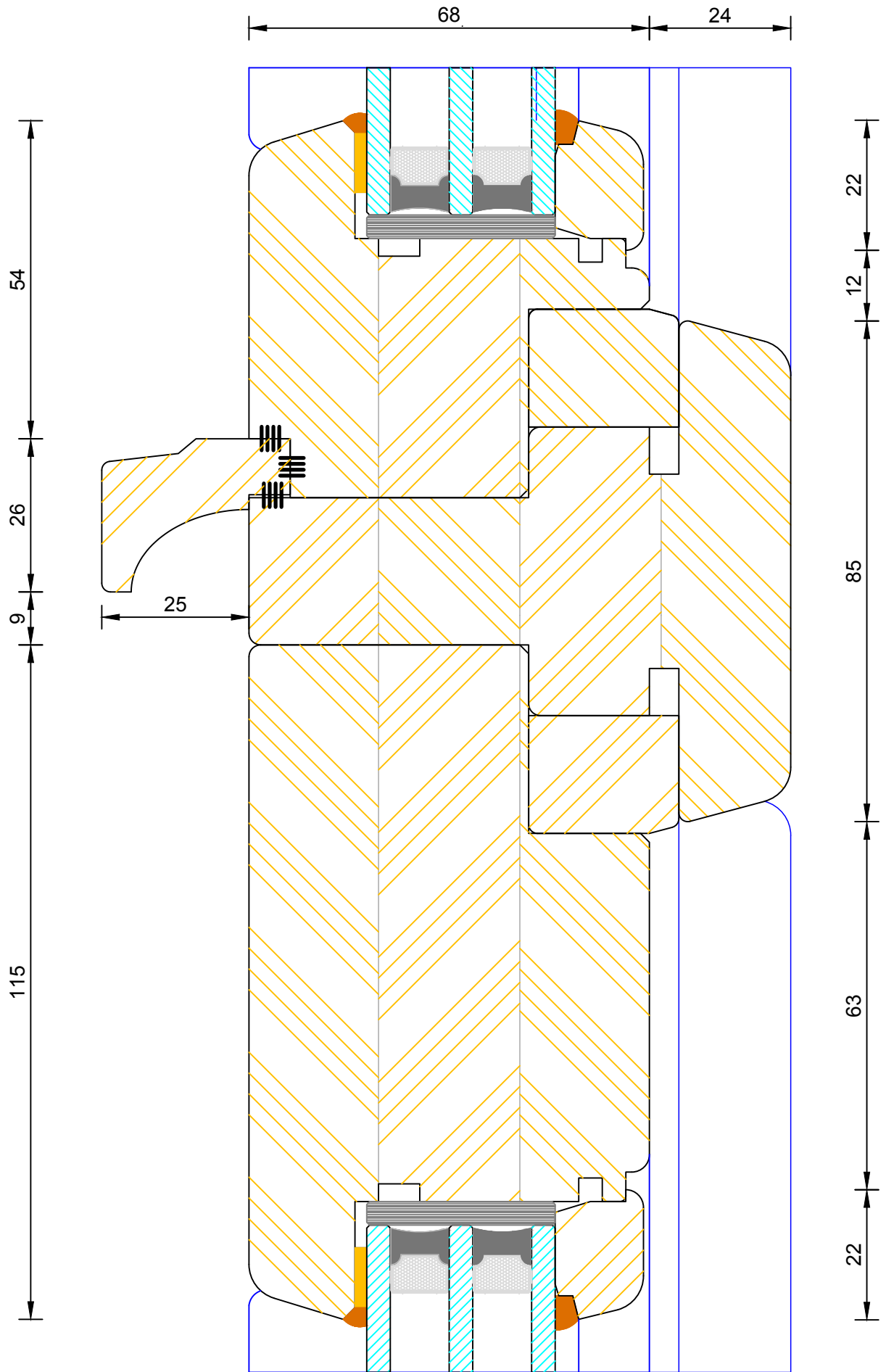
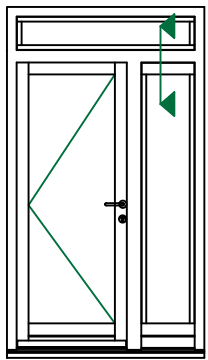

**Bereco**

**Creative Open Out Flush Entrance Door**  
 Triple Glazed - Solid Transom (Fanlight / Sidelight)

DIMENSIONS	PLOT SIZE	SCALE	DATE	REV	DWG NO.
MM	A4	1:1	19.04.2012	A	<b>3568</b>

Please consider the environment before printing

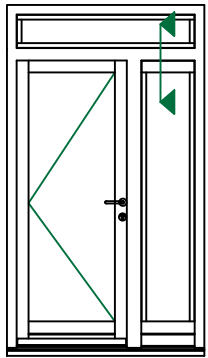
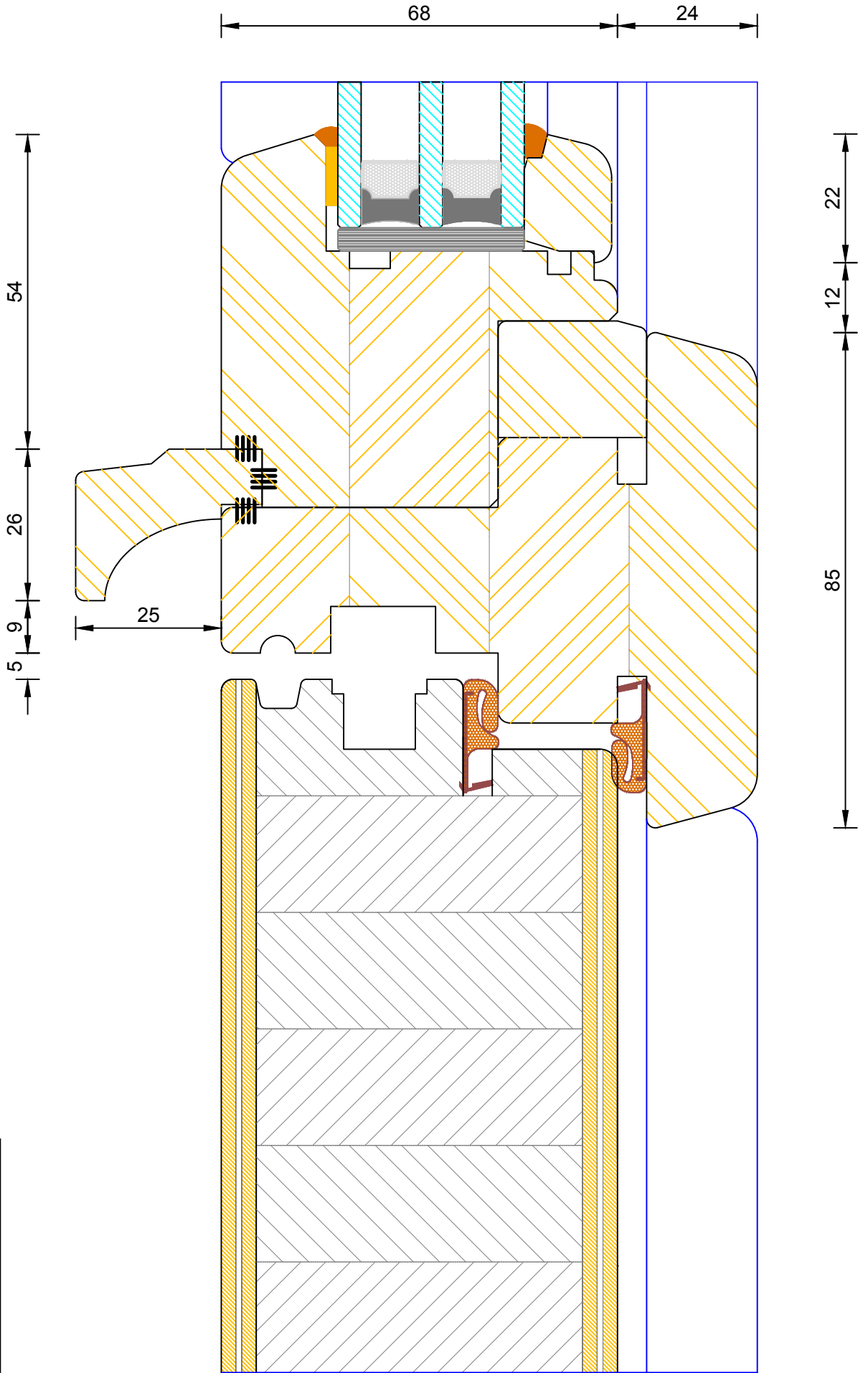

DIMENSIONS	PLOT SIZE	SCALE	DATE	REV	DWG NO.
MM	A4	1:1	19.04.2012	A	<b>3569</b>

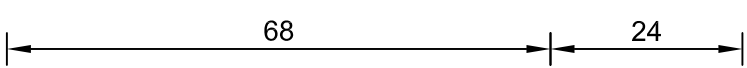
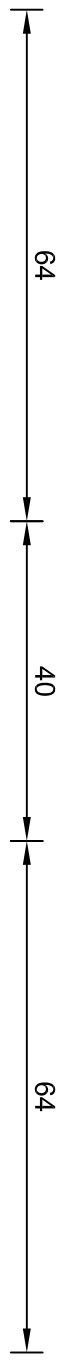
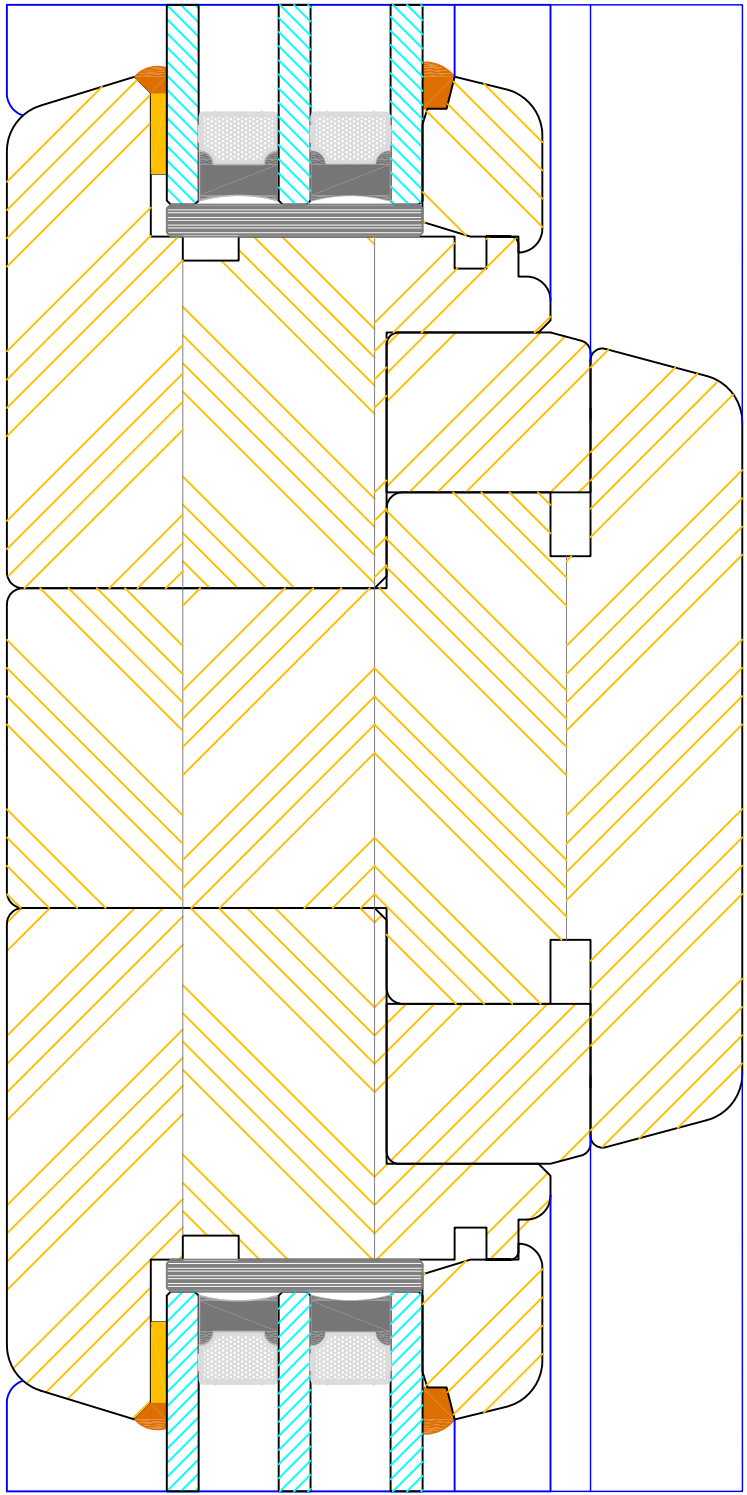
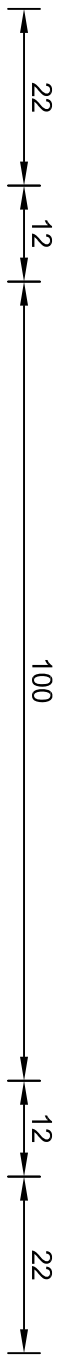

**Bereco**

**Creative Open Out Flush Entrance Door**  
**Triple Glazed - Solid Mullion (Fixed Light / Fixed Light)**

DIMENSIONS	PLOT SIZE	SCALE	DATE	REV	DWG. NO.
MM	A4	1:1	19.04.2012	A	<b>3570</b>

Please consider the environment before printing

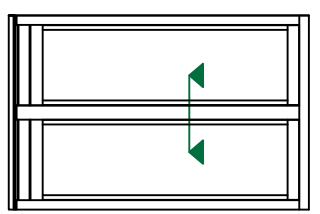

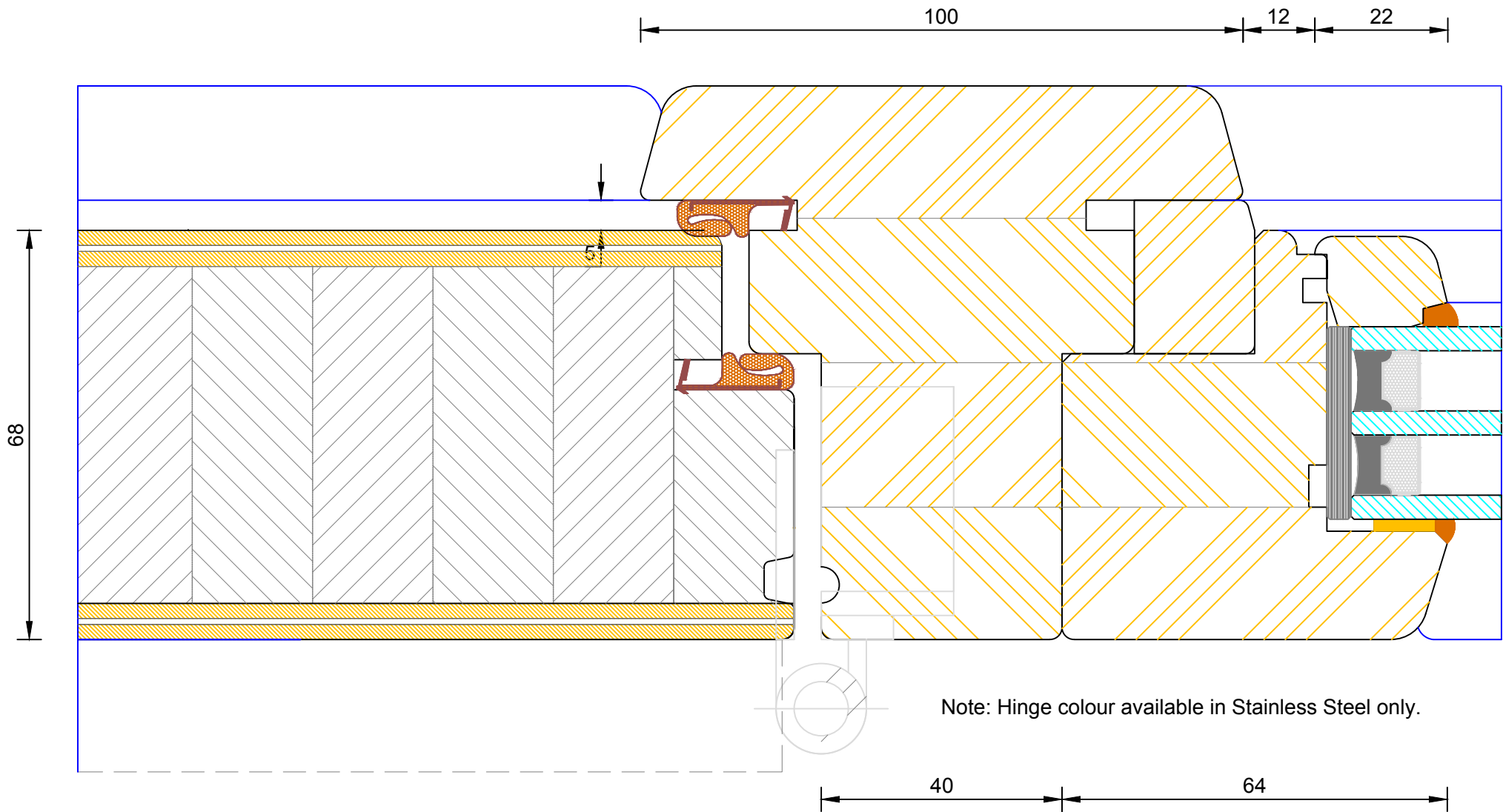

**Creative Open Out Flush Entrance Door**  
**Triple Glazed - Solid Mullion (Leaf / Side Light)**

DIMENSIONS	PLOT SIZE	SCALE	DATE	REV	DWG NO.
MM	A4	1:1	19.04.2012	A	<b>3571</b>
Please consider the environment before printing					

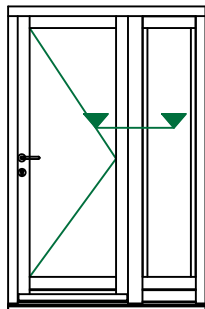

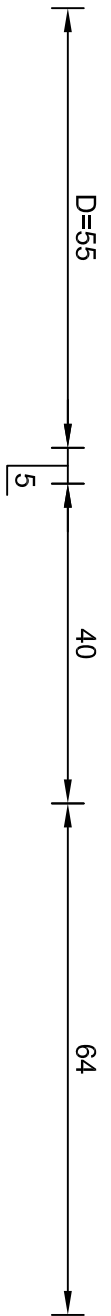
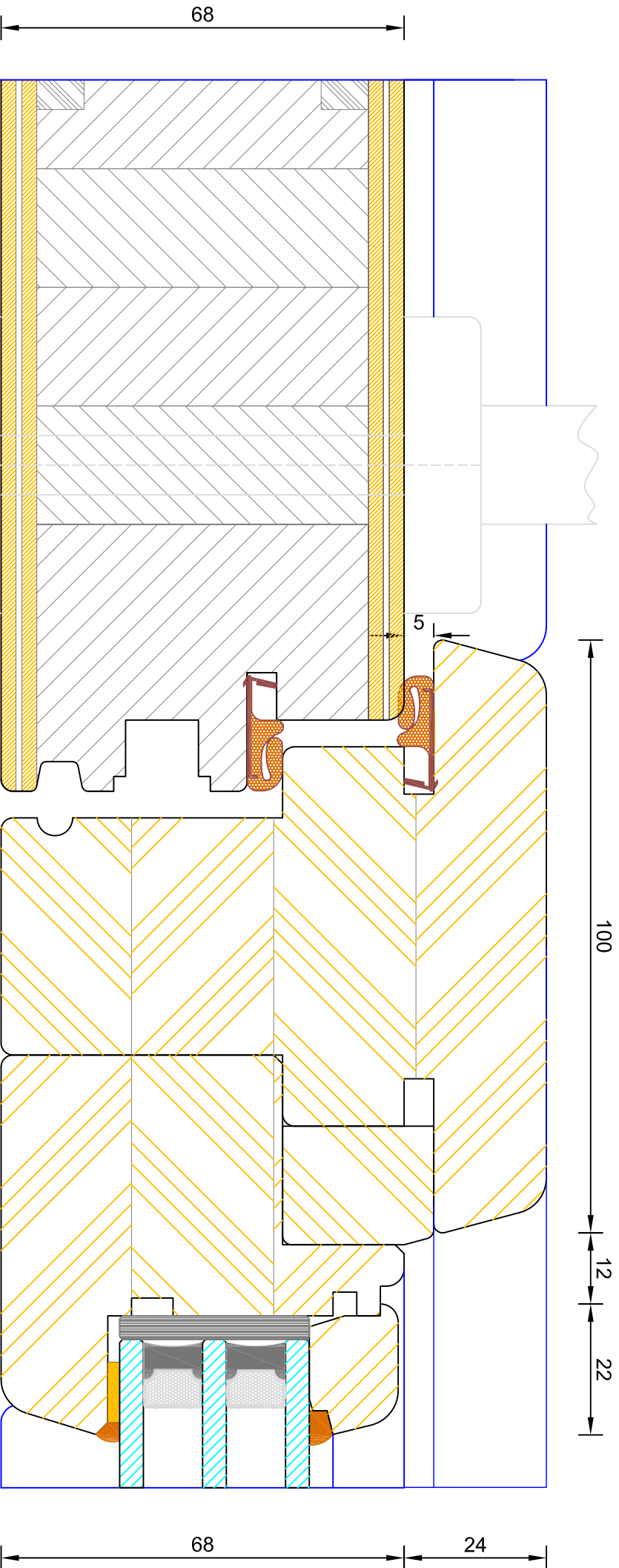

**Creative Open Out Flush Entrance Door**  
**Triple Glazed - Solid Mullion (Leaf / Side Light)**

DIMENSIONS	PLOT SIZE	SCALE	DATE	REV	DWG. NO.
MM	A4	1:1	19.04.2012	A	<b>3572</b>

Please consider the environment before printing

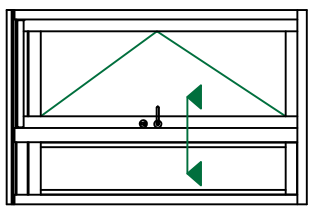



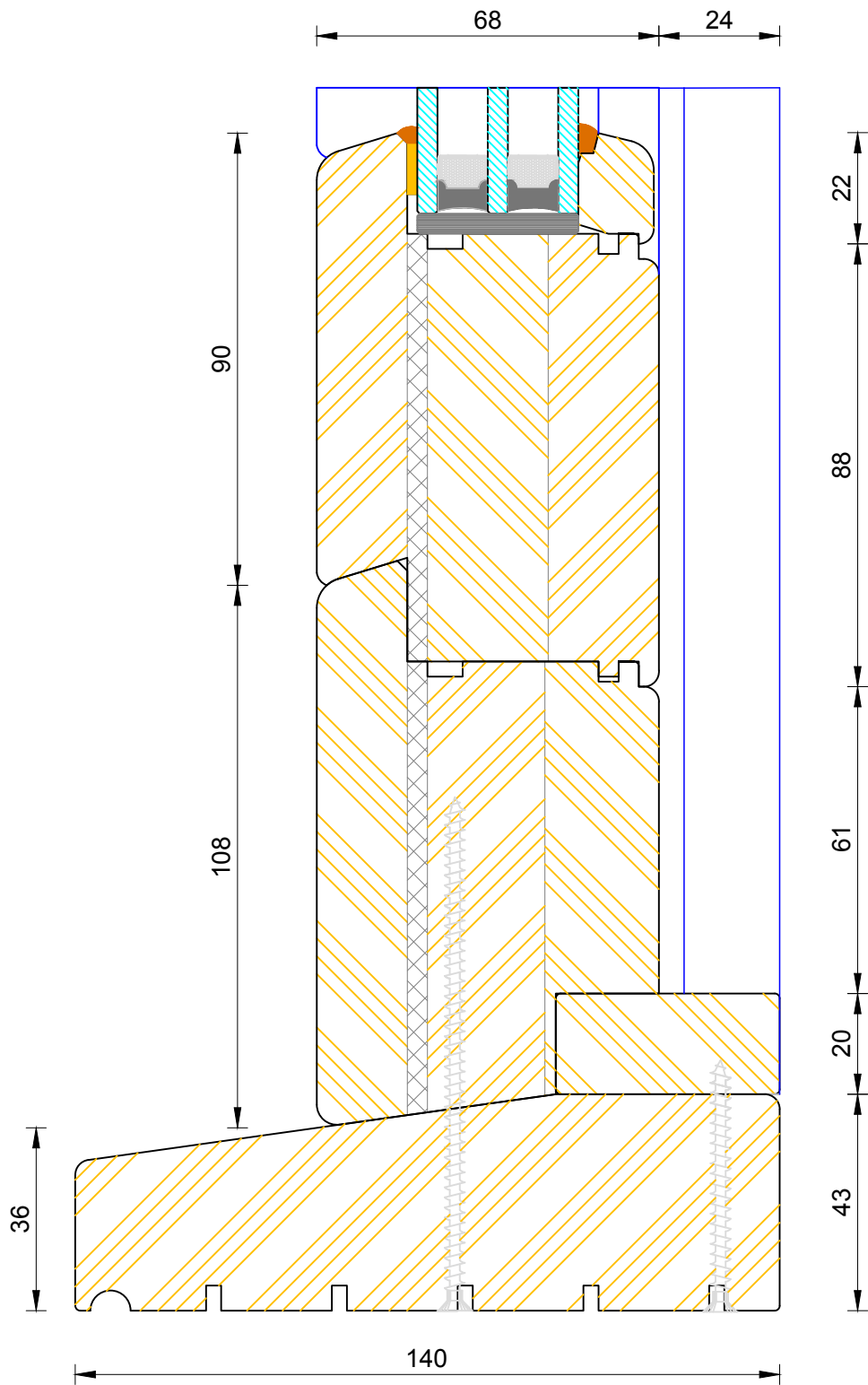
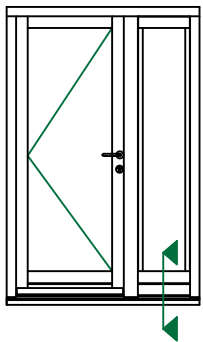

DIMENSIONS	PLOT SIZE	SCALE	DATE	REV	DWG NO.
MM	A3	1:1	19.04.2012	A	<b>3557</b>

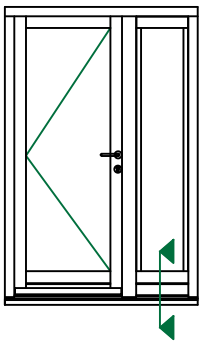
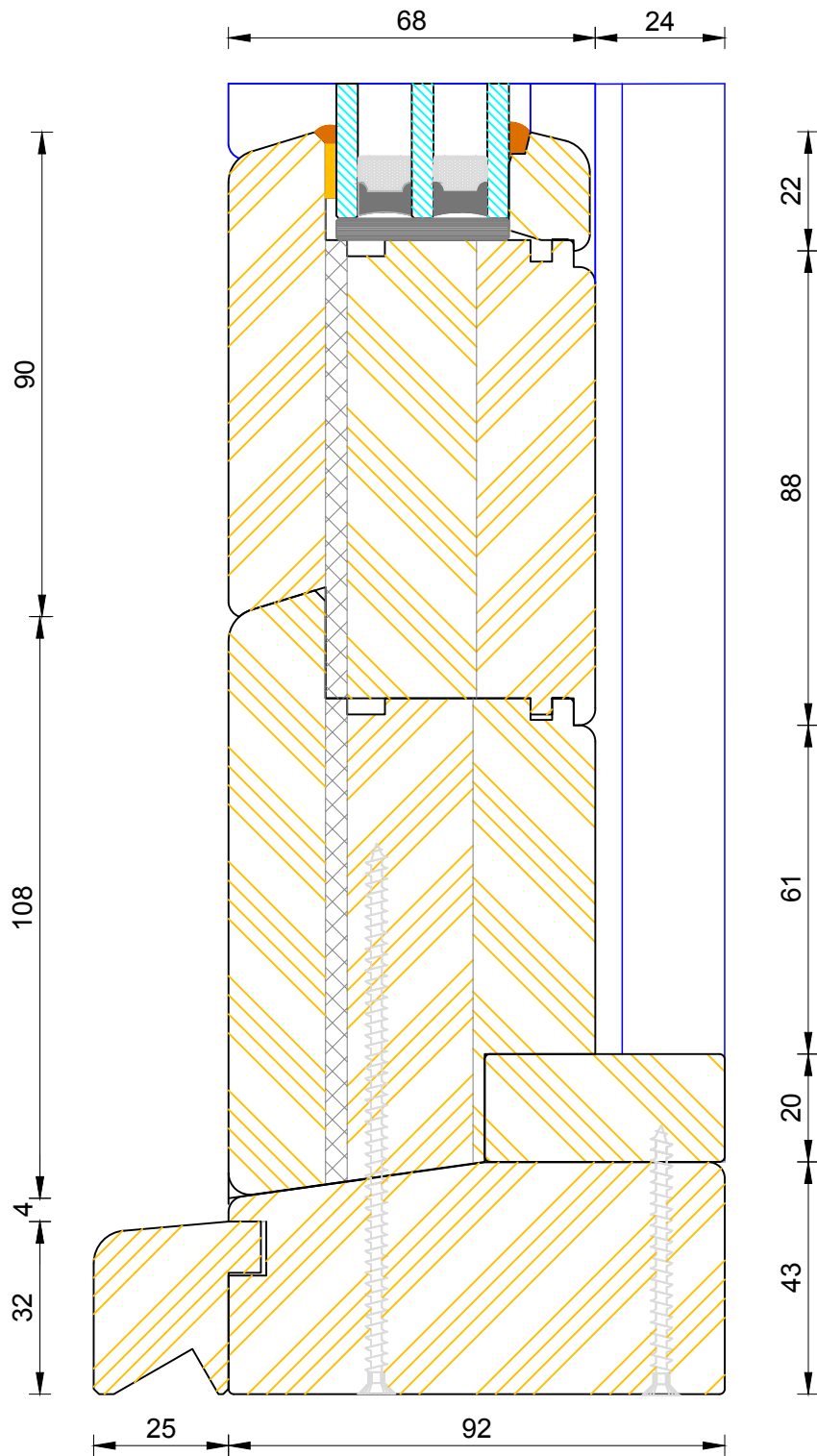

CILL EXTENSION - available options: 25mm (117mm o/a) / 47mm (139mm o/a) / 62mm (154mm o/a) / 87mm (179mm o/a) / 114mm (206mm o/a) / 125mm (217mm o/a) / 140mm (232mm o/a)

NOTE: Cill Extensions should be supported from underneath; the maximum overhang over Brick / Blockwork for cill extension should not exceed 25mm in order to avoid damage when stepped on. Warranties are invalidated when fitted with overhang in excess to that.

If not otherwise stated, Hardwood Threshold will be painted the same colour as Frame.



### Creative Open Out Flush Entrance Door Triple Glazed - Coupling Thresh (Sidelight)

DIMENSIONS	PLOT SIZE	SCALE	DATE	REV	DWG NO.
MM	A3	1:1	19.04.2012	A	<b>3558</b>

Please consider the environment before printing

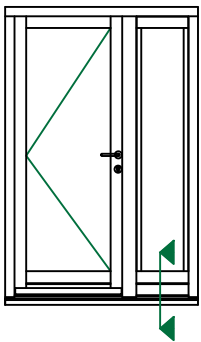
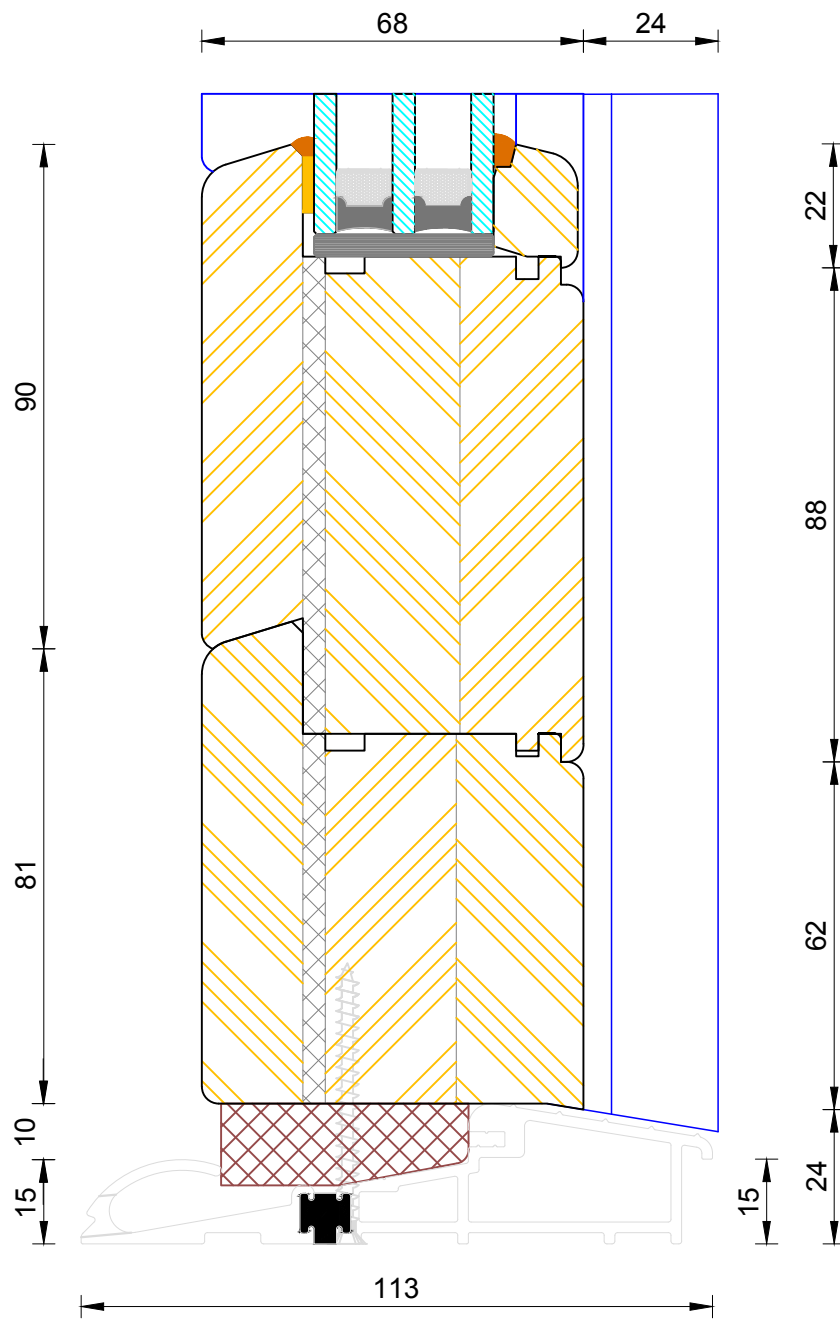

**Creative Open Out Flush Entrance Door**  
**Triple Glazed - Mobility Thresh (Sidelight)**

DIMENSIONS	PLOT SIZE	SCALE	DATE	REV	DWG NO.
MM	A3	1:1	19.04.2012	A	<b>3559</b>

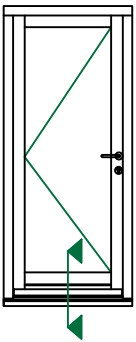
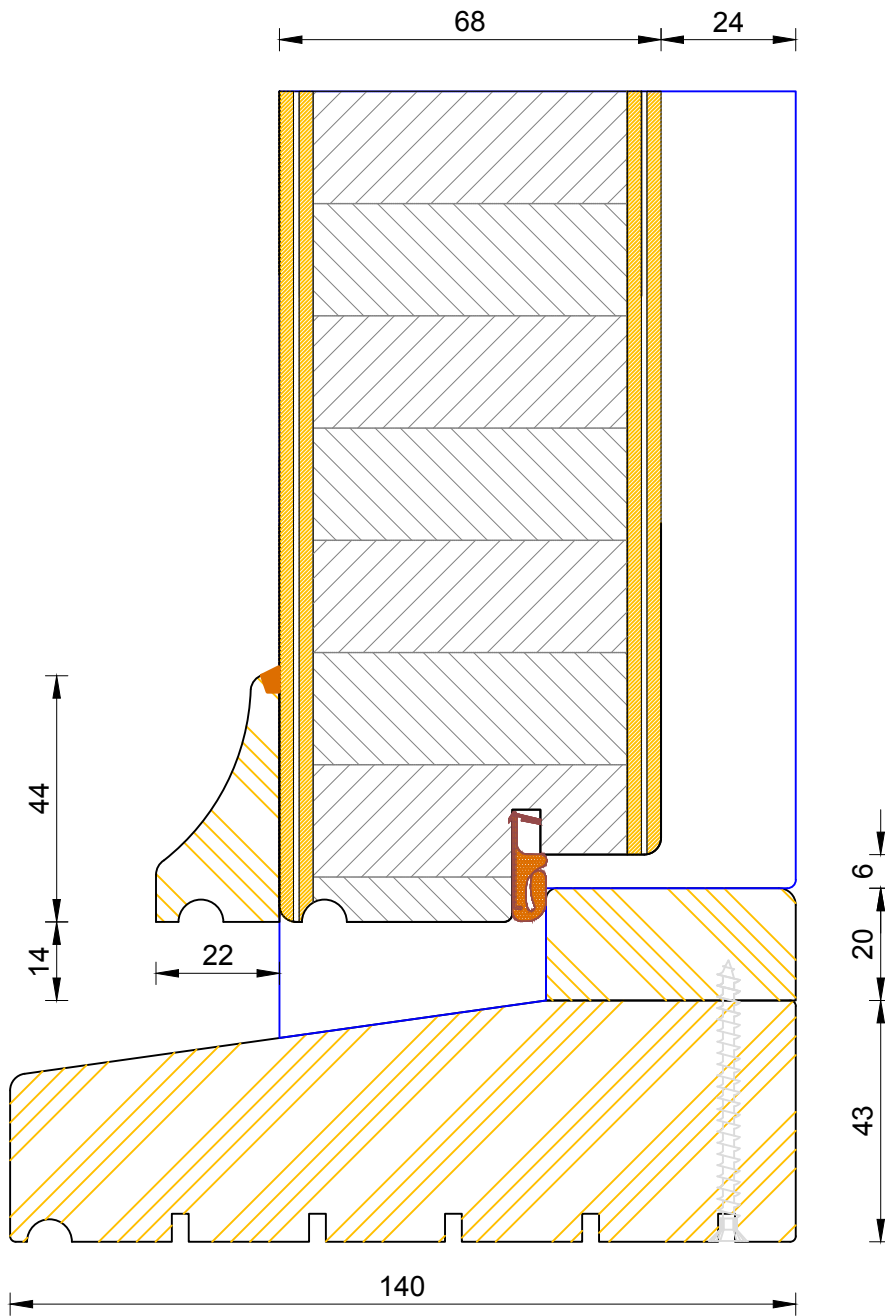

**Creative Open Out Flush Entrance Door**  
 Triple Glazed - Standard Thresh (140x43mm)

DIMENSIONS	PLOT SIZE	SCALE	DATE	REV	DWG NO.
MM	A3	1:1	19.04.2012	A	<b>3564</b>

Please consider the environment before printing

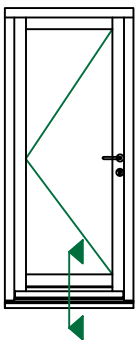
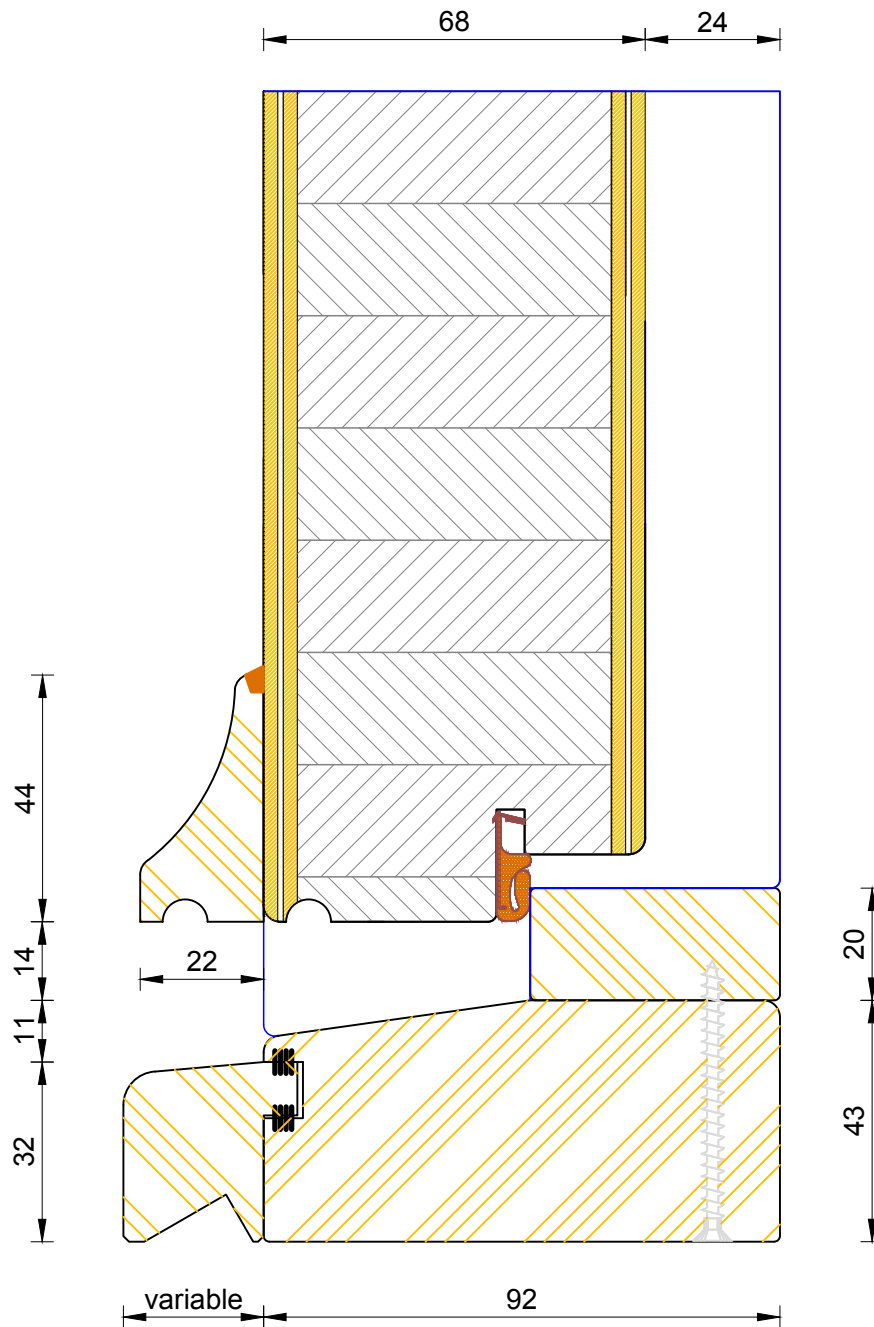

CILL EXTENSION - available options: 25mm (117mm o/a) / 47mm (139mm o/a) / 62mm (154mm o/a) / 87mm (179mm o/a) / 114mm (206mm o/a) / 125mm (217mm o/a) / 140mm (232mm o/a)

NOTE: Cill Extensions should be supported from underneath; the maximum overhang over Brick / Blockwork for cill extension should not exceed 25mm in order to avoid damage when stepped on. Warranties are invalidated when fitted with overhang in excess to that.

If not otherwise stated, Hardwood Threshold will be painted the same colour as Frame.

