

Section B-B

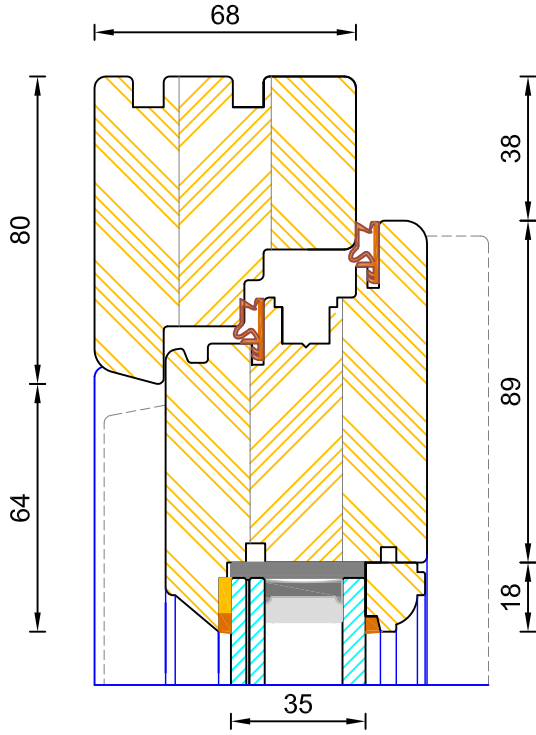

Section A-A

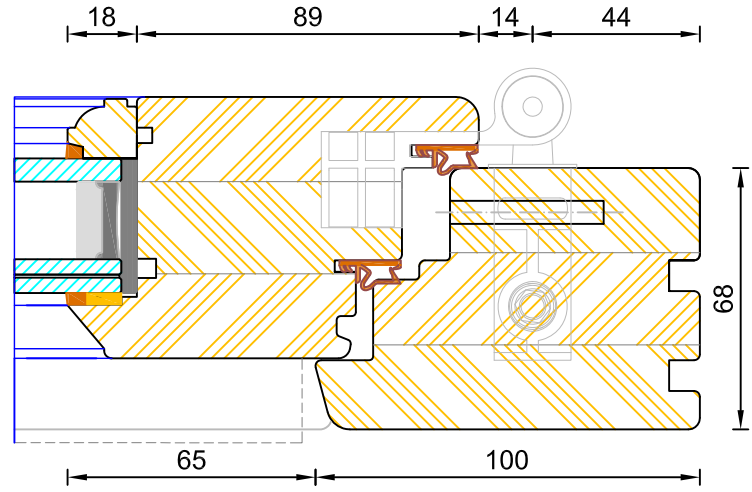

Section D-D

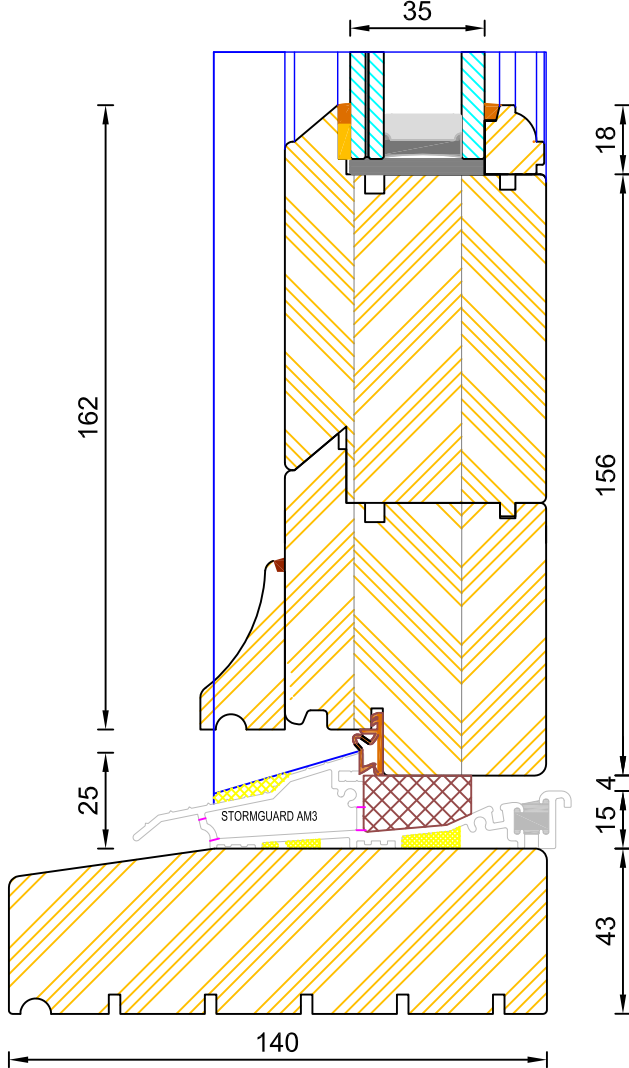

Section C-C

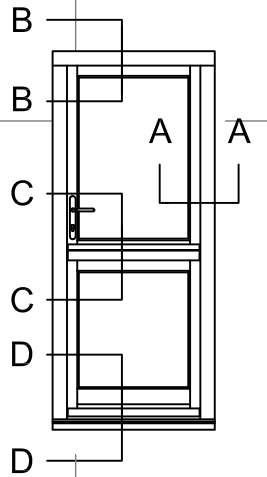
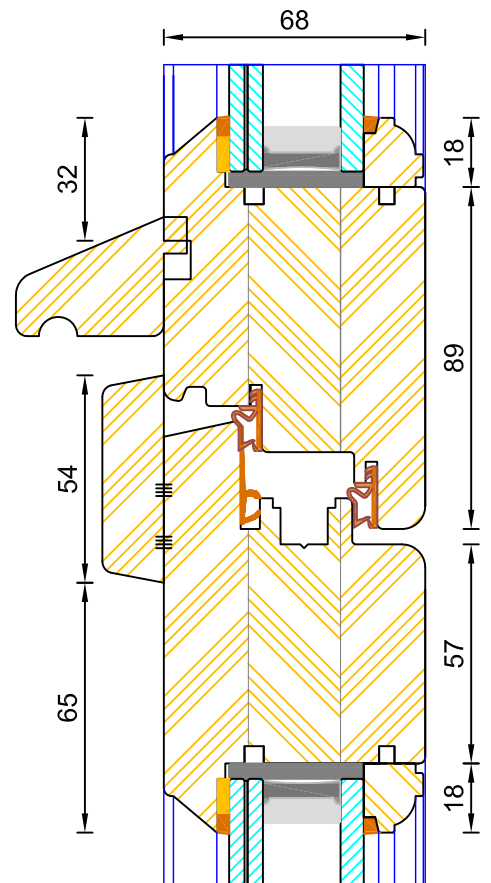

Typical sections showing acoustic glass - 8.8/20ar/6ESGT (**39 dB**) For full sectional details please refer to our standard double glazed sections



Traditional Open In Stable Door
Frame & Leaf Sections - Acoustic Rating 38dB

DIMENSIONS	PLOT SIZE	SCALE	DATE	REV	DWG NO.
MM	A2	1:1	10.11.2016	A	3750
Please consider the environment before printing					

Section B-B

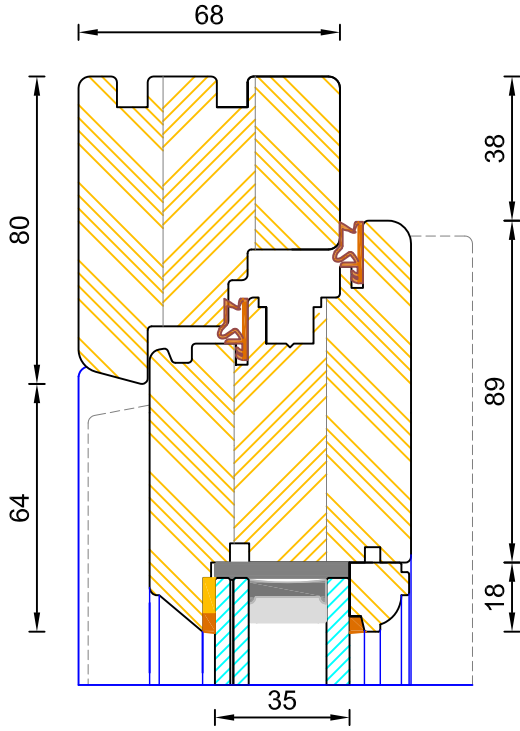

Section A-A

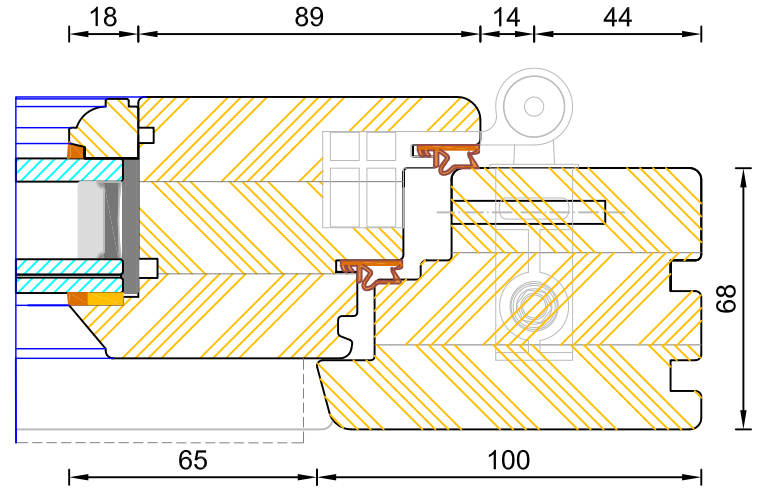

Section D-D

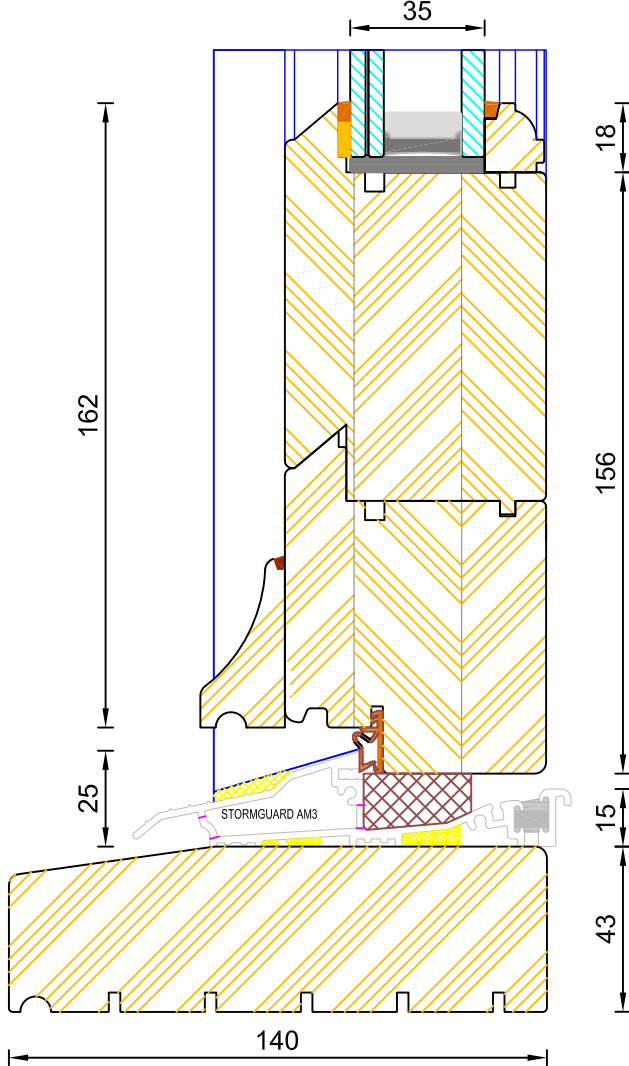

Section C-C

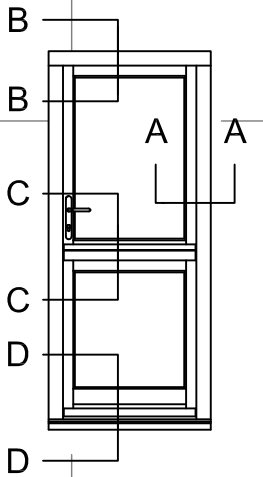
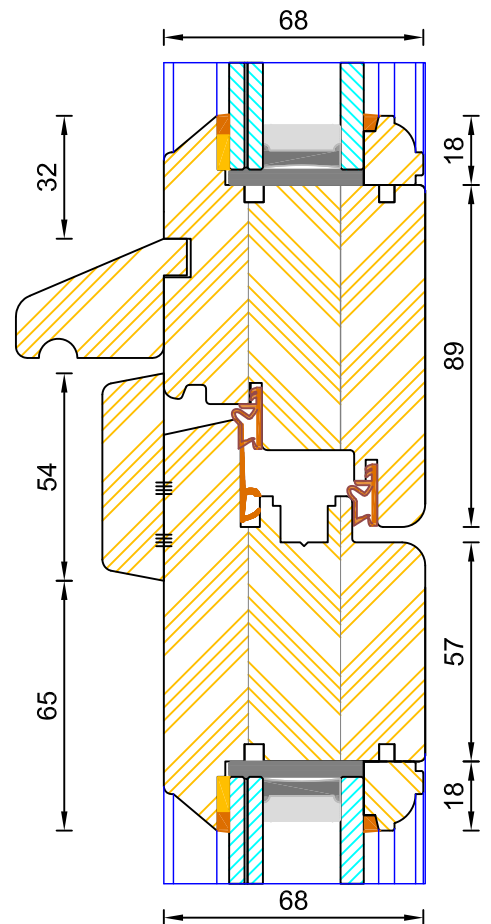

Typical sections showing acoustic glass - 8.8Aku/20ar/6ESGT (42 dB) For full sectional details please refer to our standard double glazed sections



Traditional Open In Stable Door
Frame & Leaf Sections - Acoustic Rating 41dB

DIMENSIONS	PLOT SIZE	SCALE	DATE	REV	DWG NO.
MM	A2	1:1	10.11.2016	A	3751
Please consider the environment before printing					

Section B-B

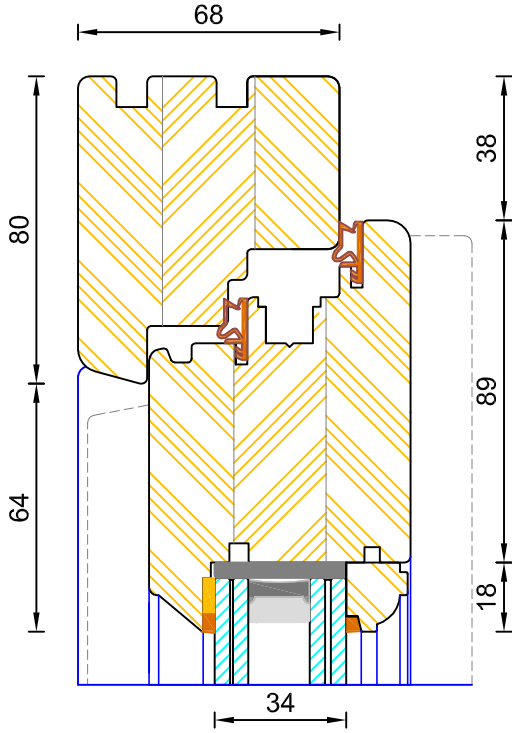

Section A-A

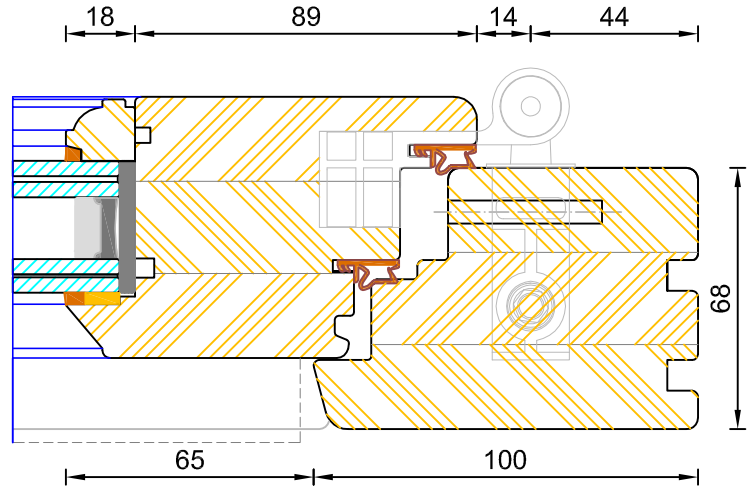

Section D-D

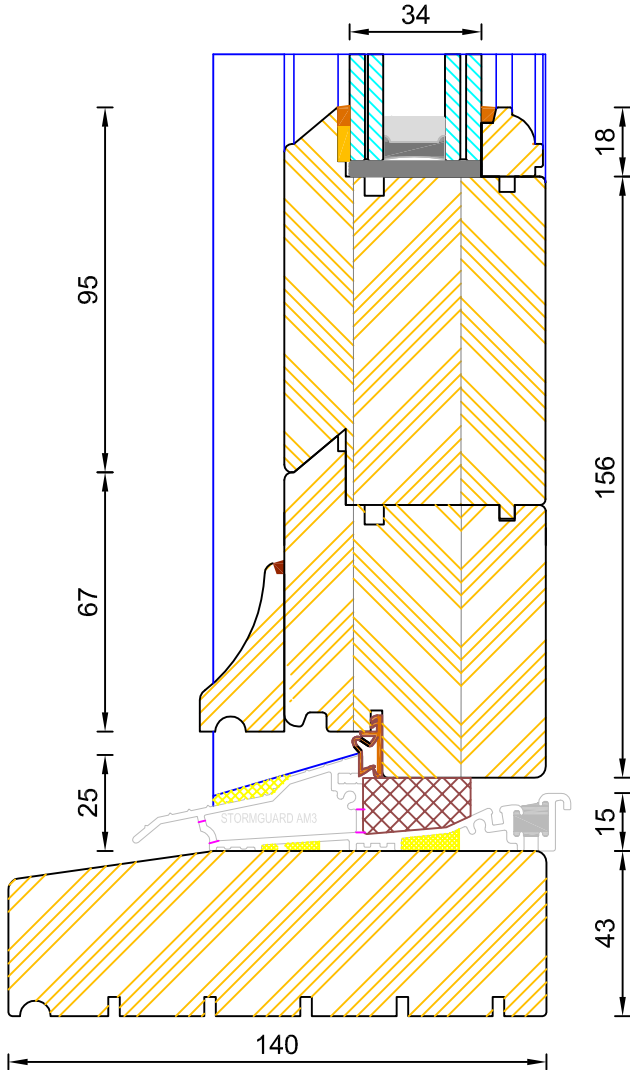

Section C-C

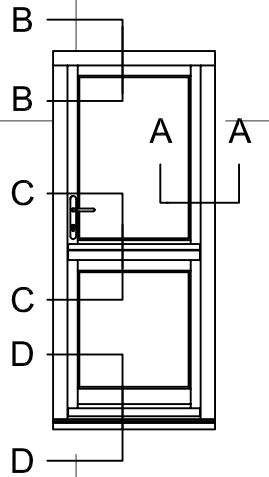
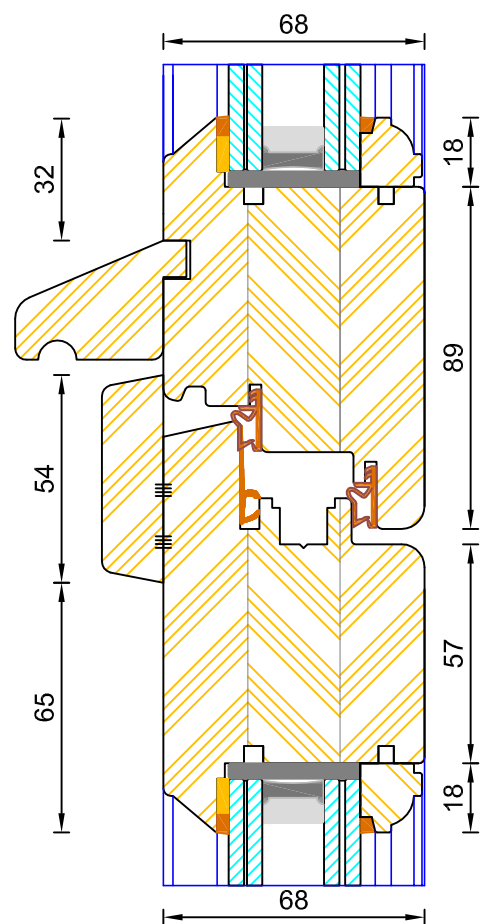

Typical sections showing acoustic glass - 9.5/16Ar/8.8T(Aku) CG A 1.0 (45dB) For full sectional details please refer to our standard double glazed sections



Traditional Open in Stable Door
Frame & Leaf Sections - Acoustic Rating 42dB

DIMENSIONS	PLOT SIZE	SCALE	DATE	REV	DWG NO.
MM	A2	1:1	29.08.2019	B	3752
Please consider the environment before printing					