

**Contemporary Open Out Folding Sliding Door
Cill Extension Options**

DIMENSIONS	PLOT SIZE	SCALE	DATE	REV	DWG NO.
MM	A4	1:1	25.09.2019	B	4201

Please consider the environment before printing

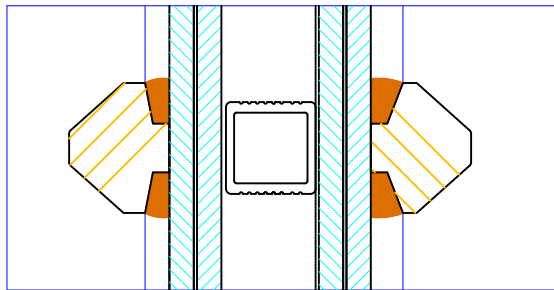

16

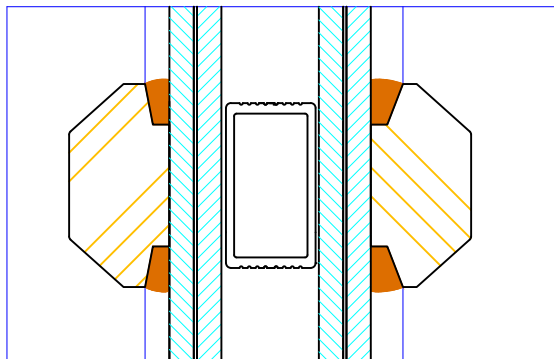

25

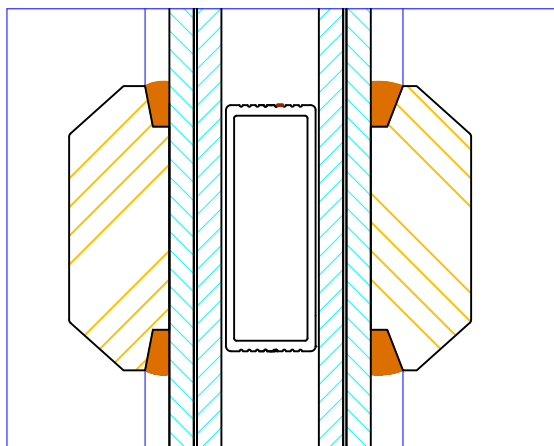

35

60 (varies min 60/ max 137mm)

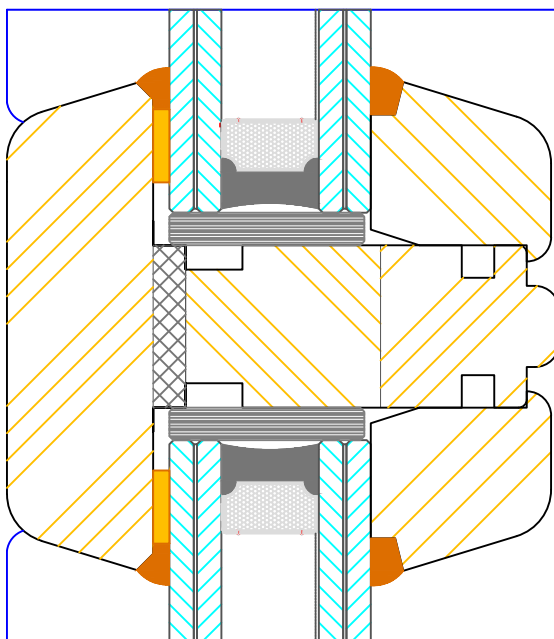

22
16
22

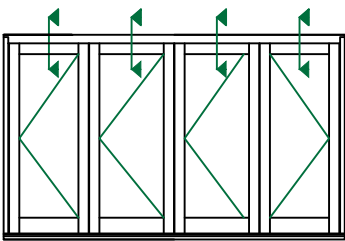
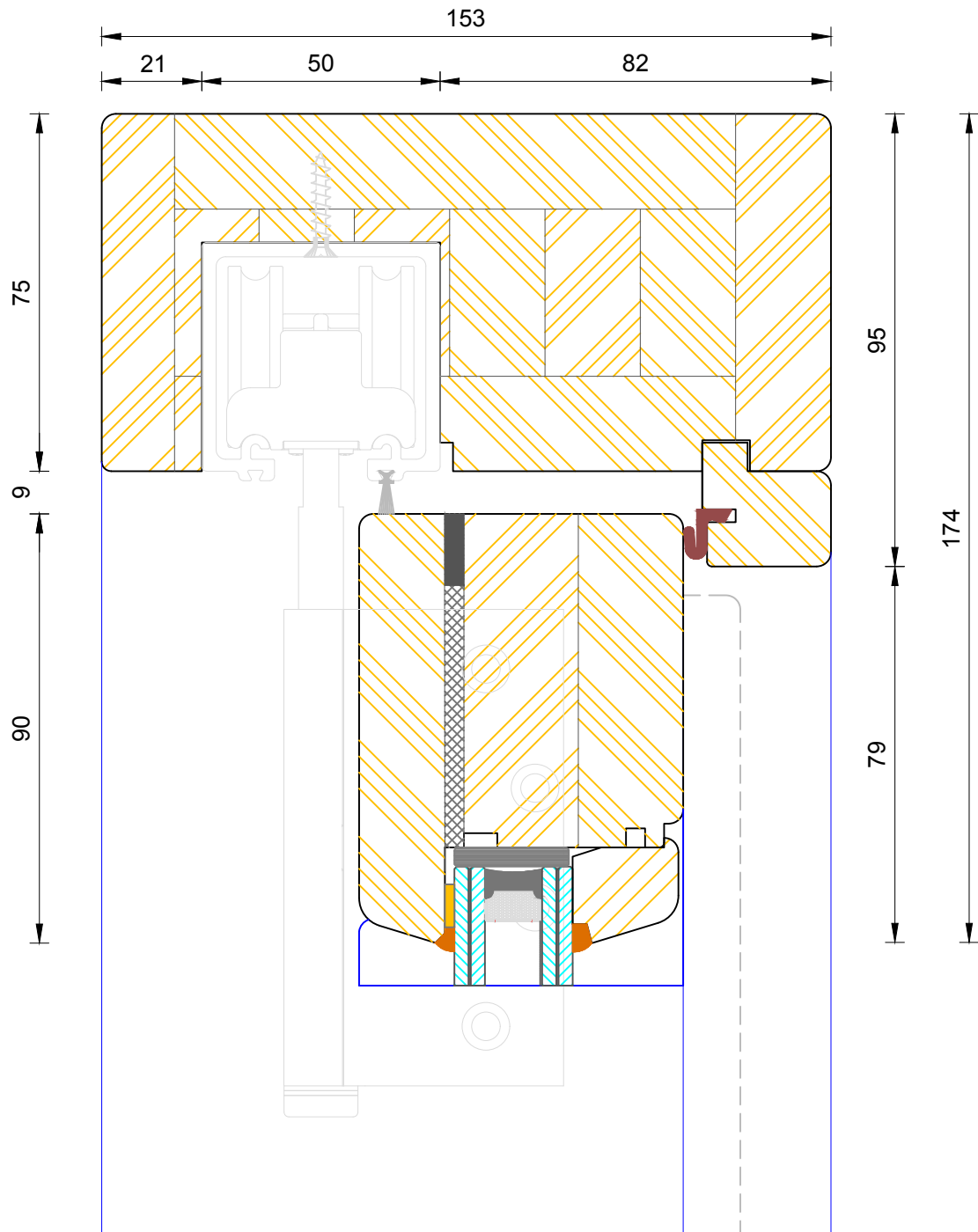

**Contemporary Open Out Folding Sliding Door
Frame & Leaf Head (Without Vent)**

DIMENSIONS	PLOT SIZE	SCALE	DATE	REV	DWG NO.
MM	A3	1:1	02.05.2012	A	4205

Please consider the environment before printing

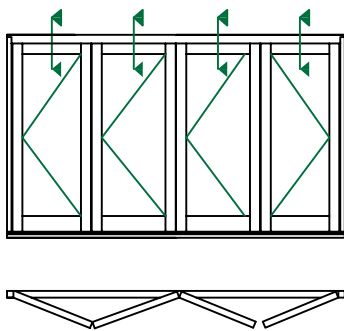
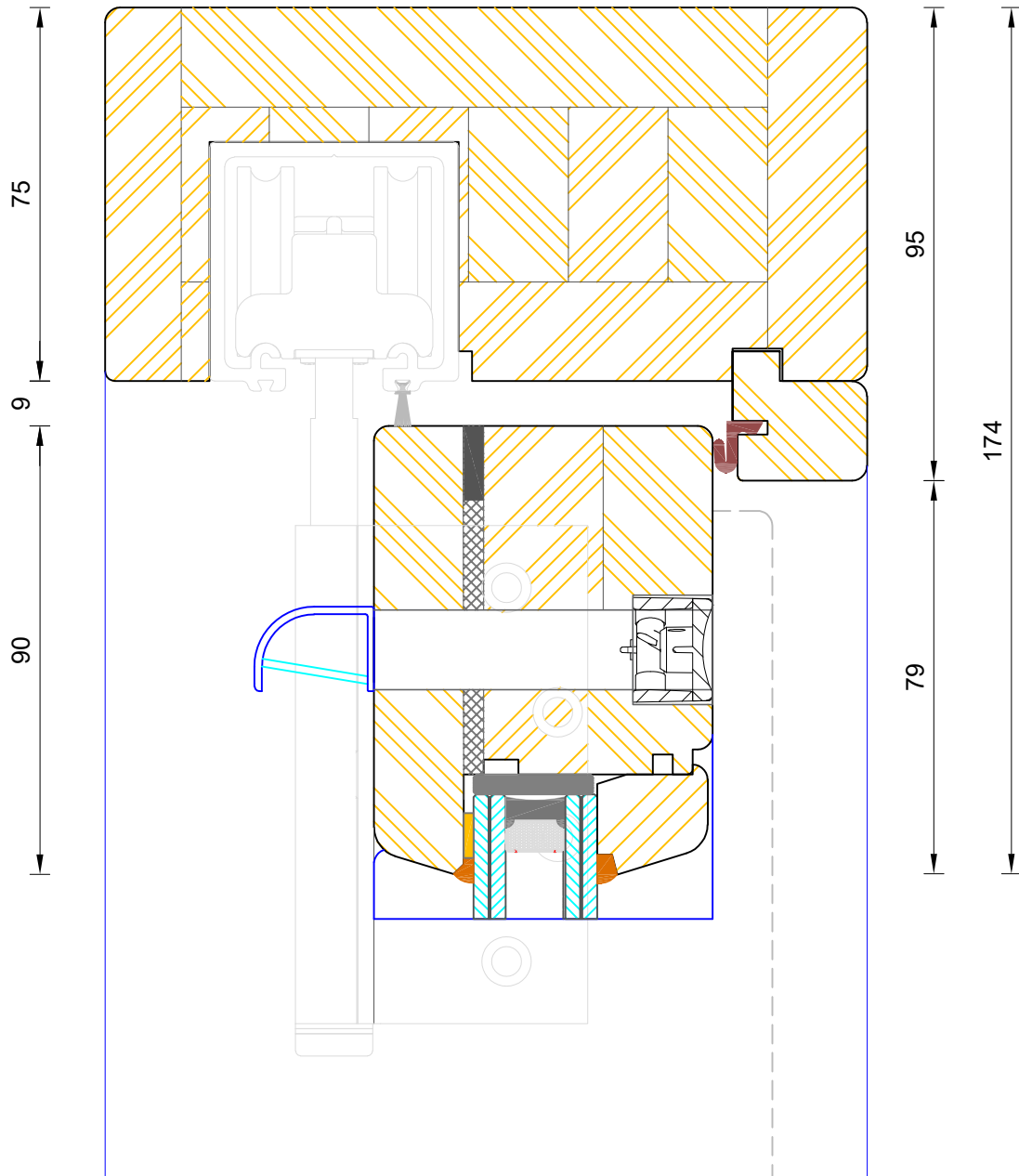

Model Numbers	Vent Location (Leaves from left to right)
ALL 2 LEAF MODELS	1 & 2
330 / 303	1 (330) 3 (303)
321 / 313	1 & 3
ALL 4 LEAF MODELS	1 & 4
550 / 505	1 (550) 5 (505)
541 / 514 / 532 / 523	1 & 5
ALL 6 LEAF MODELS	1 & 6
770 / 707	1 (770) 7 (707)
761 / 716 / 752 / 725 / 743 / 734	1 & 7
ALL 8 LEAF MODELS	1 & 8



Contemporary Open Out Folding Sliding Door Frame & Leaf Head (With Vent)

DIMENSIONS	PLOT SIZE	SCALE	DATE	REV	DWG NO.
MM	A3	1:1	04.07.2022	B	4205.1

Please consider the environment before printing

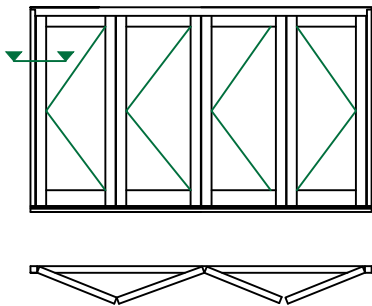
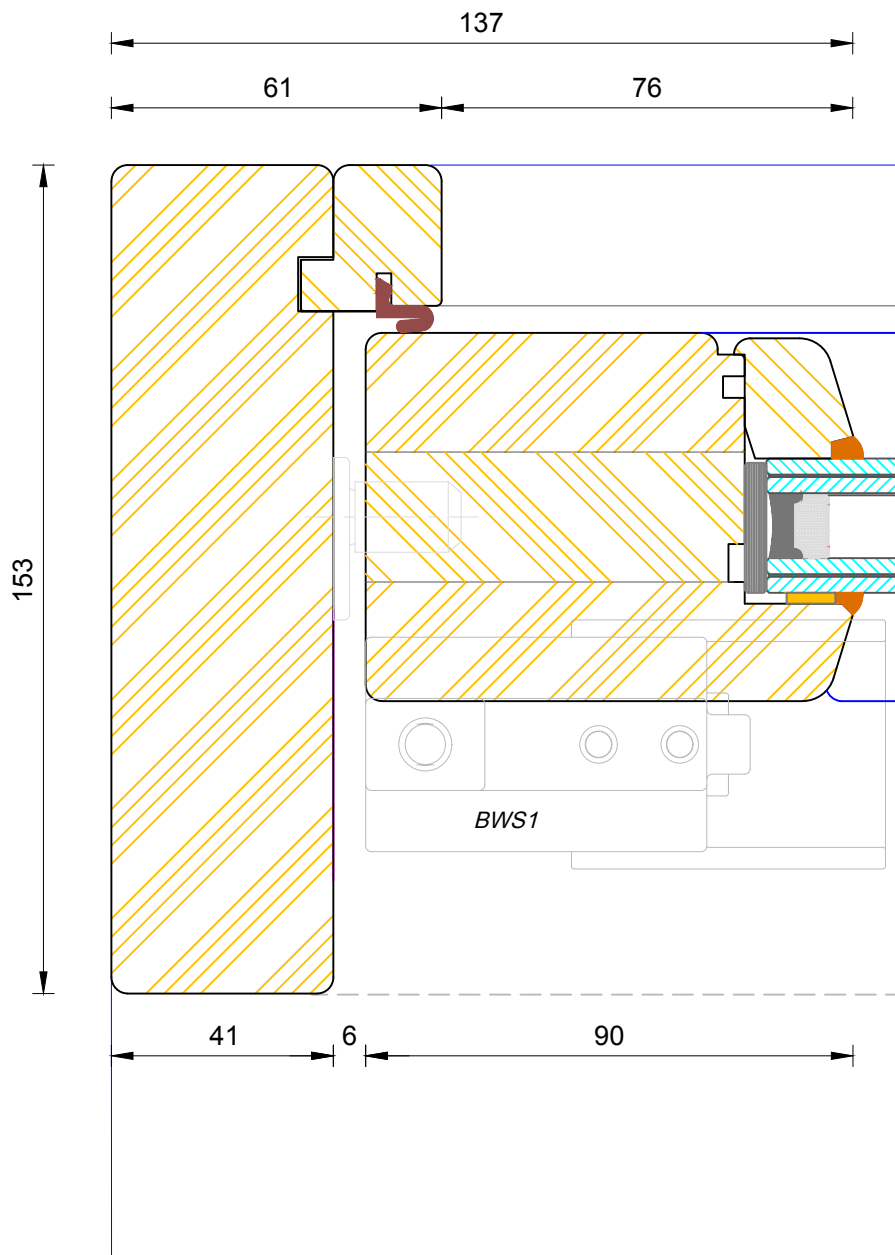

**Contemporary Open Out Folding Sliding Door
Frame & Leaf Jamb (Hinge Side)**

DIMENSIONS	PLOT SIZE	SCALE	DATE	REV	DWG NO.
MM	A3	1:1	02.05.2012	A	4206
Please consider the environment before printing					

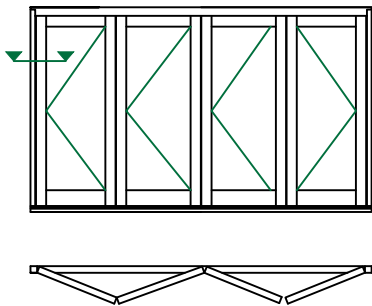
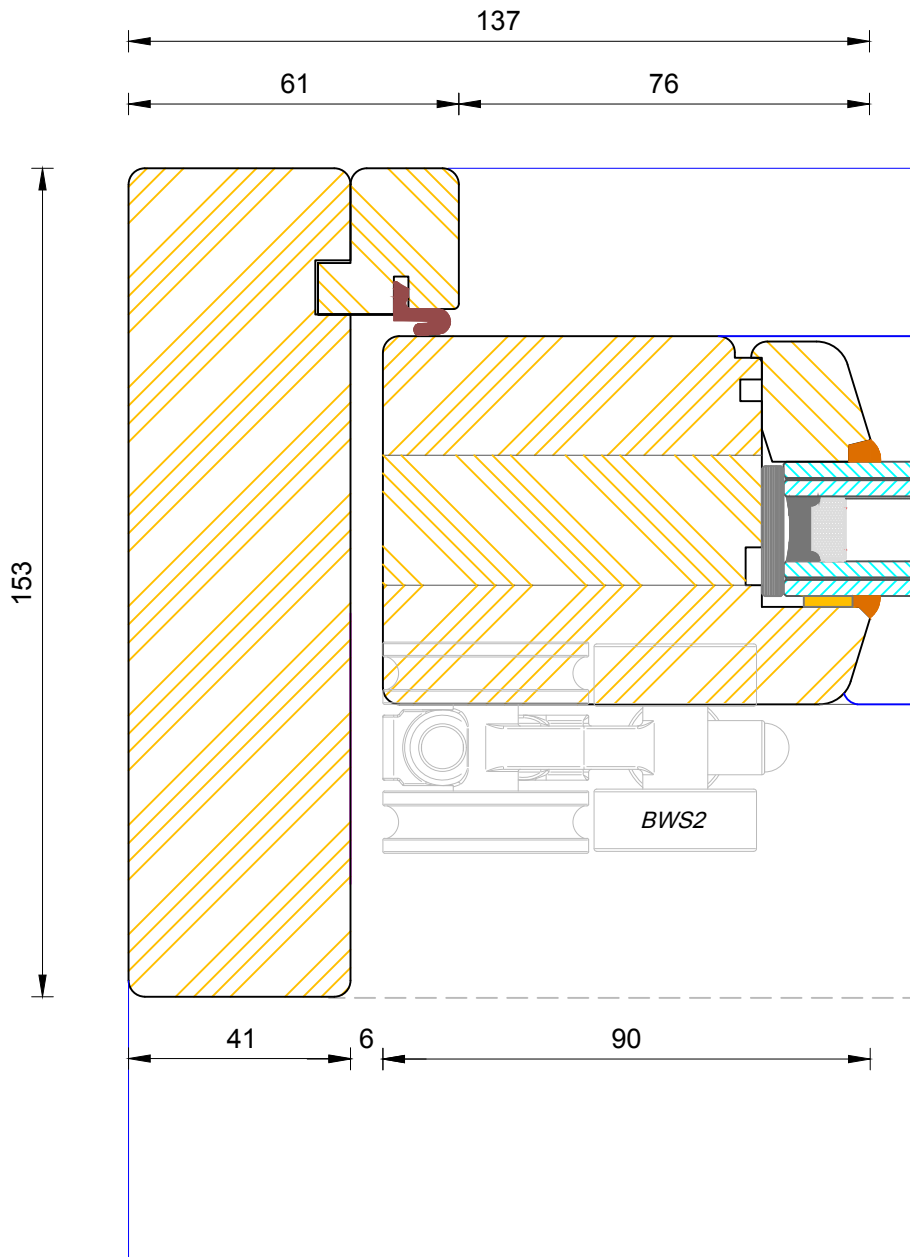

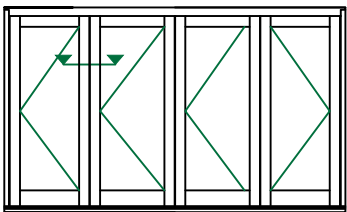
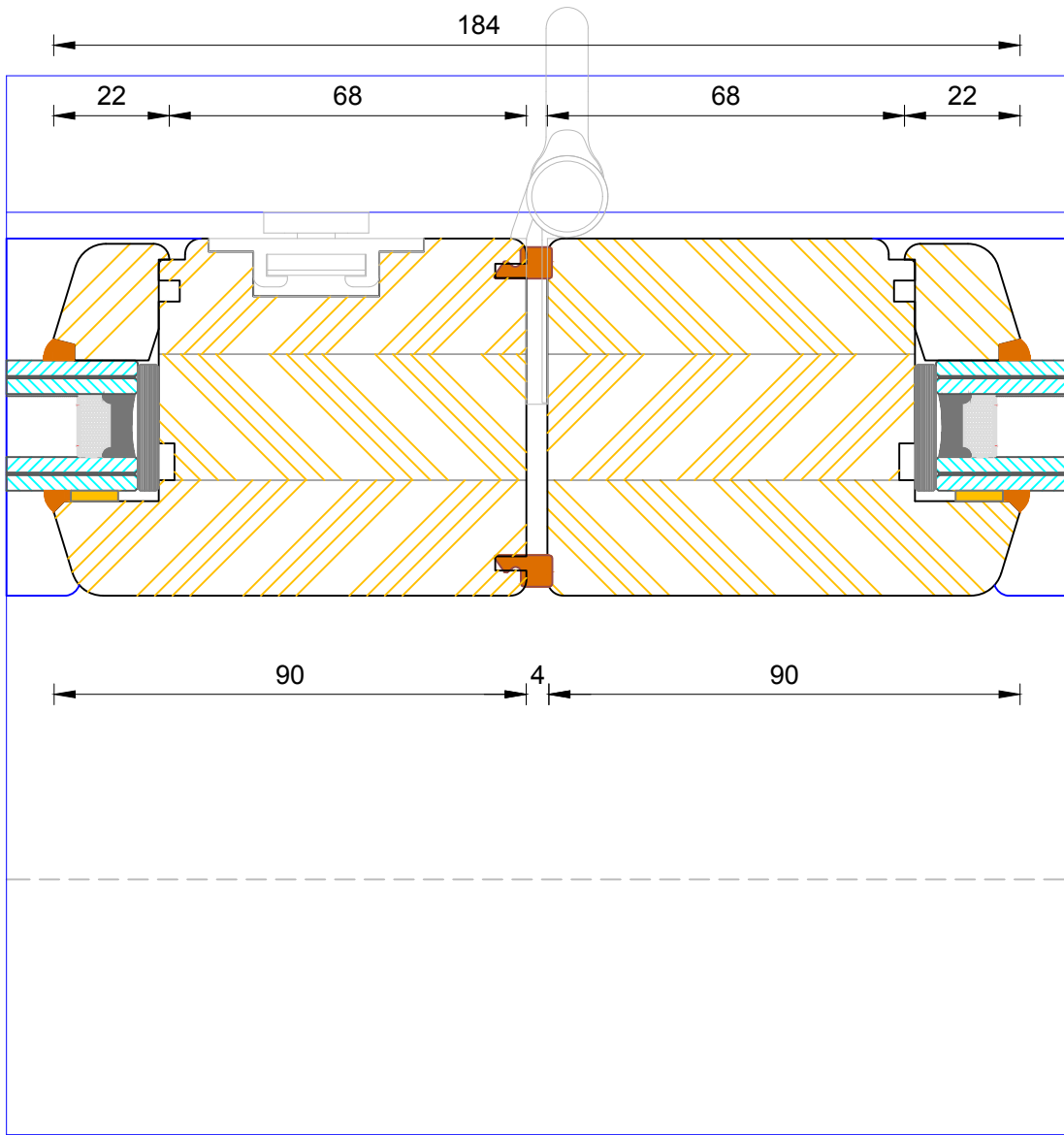

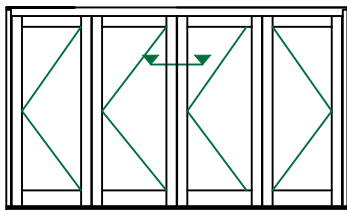
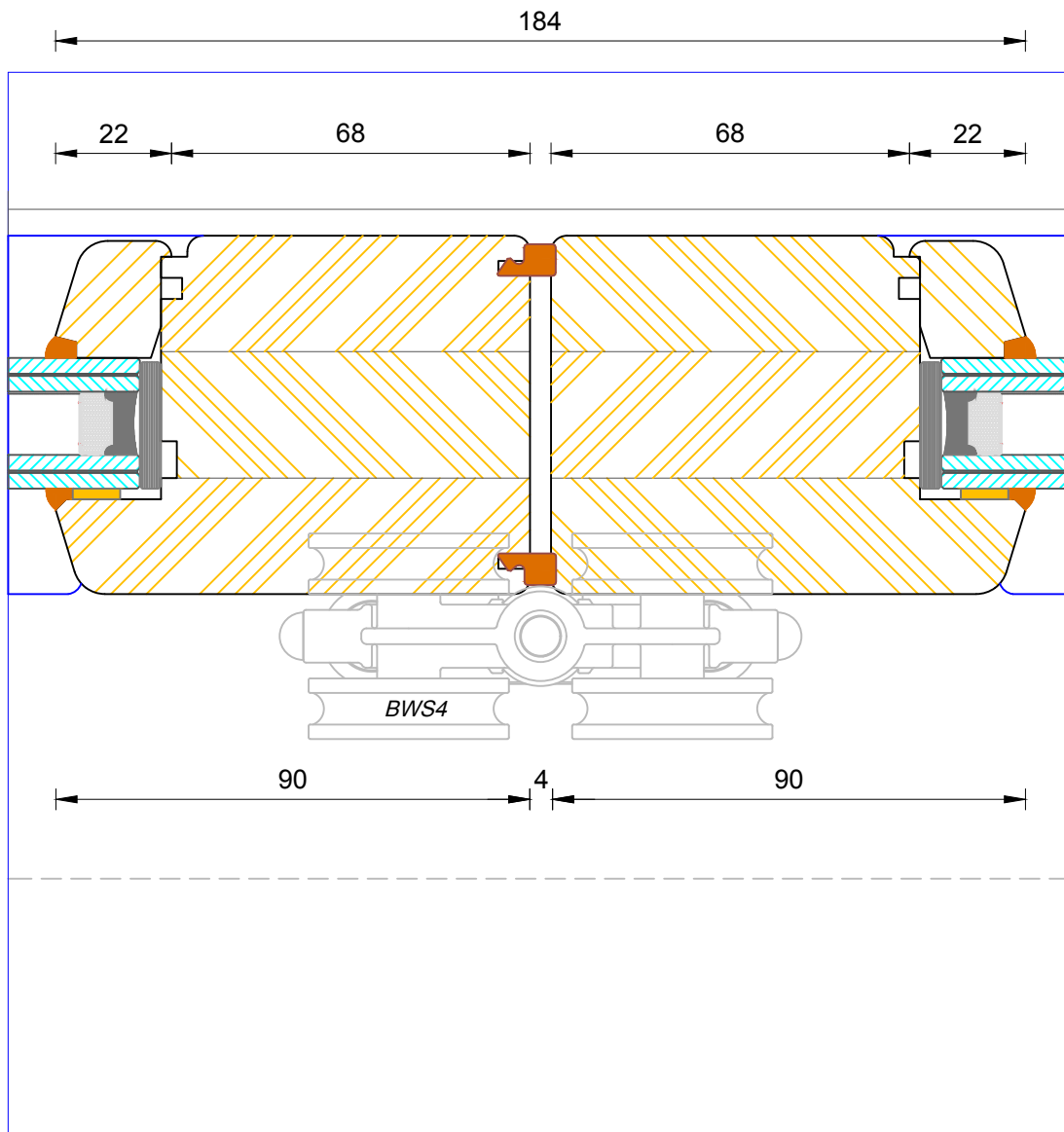

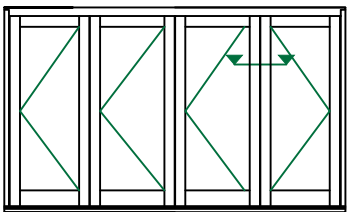
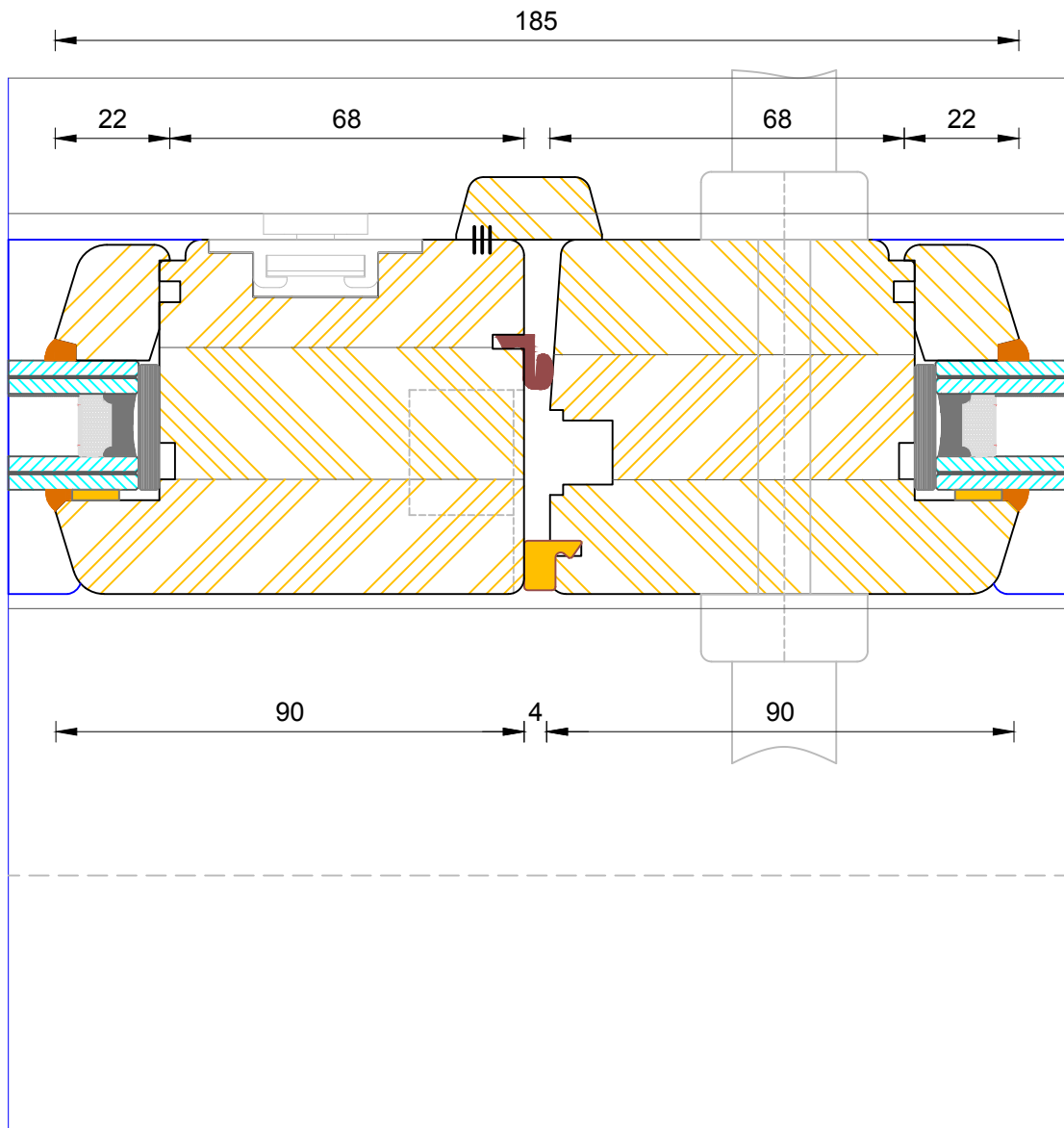

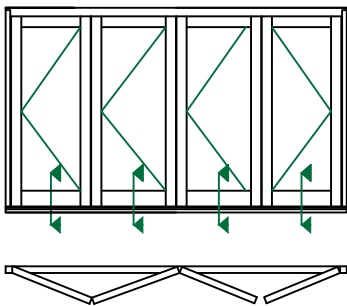
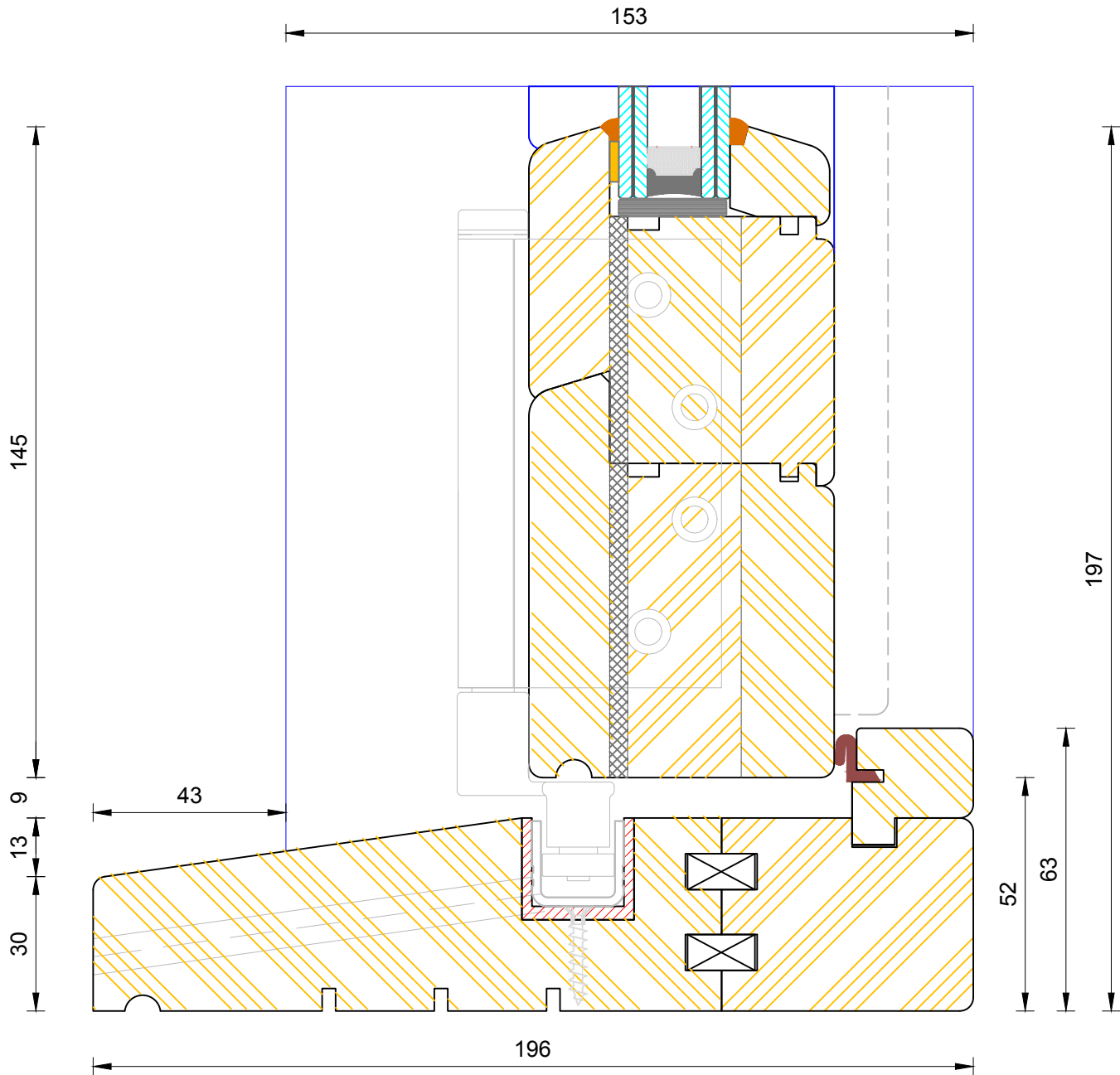

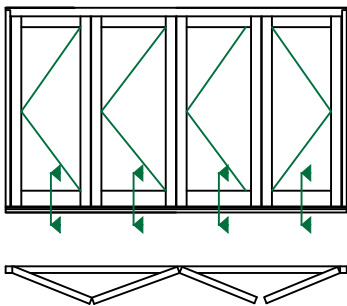
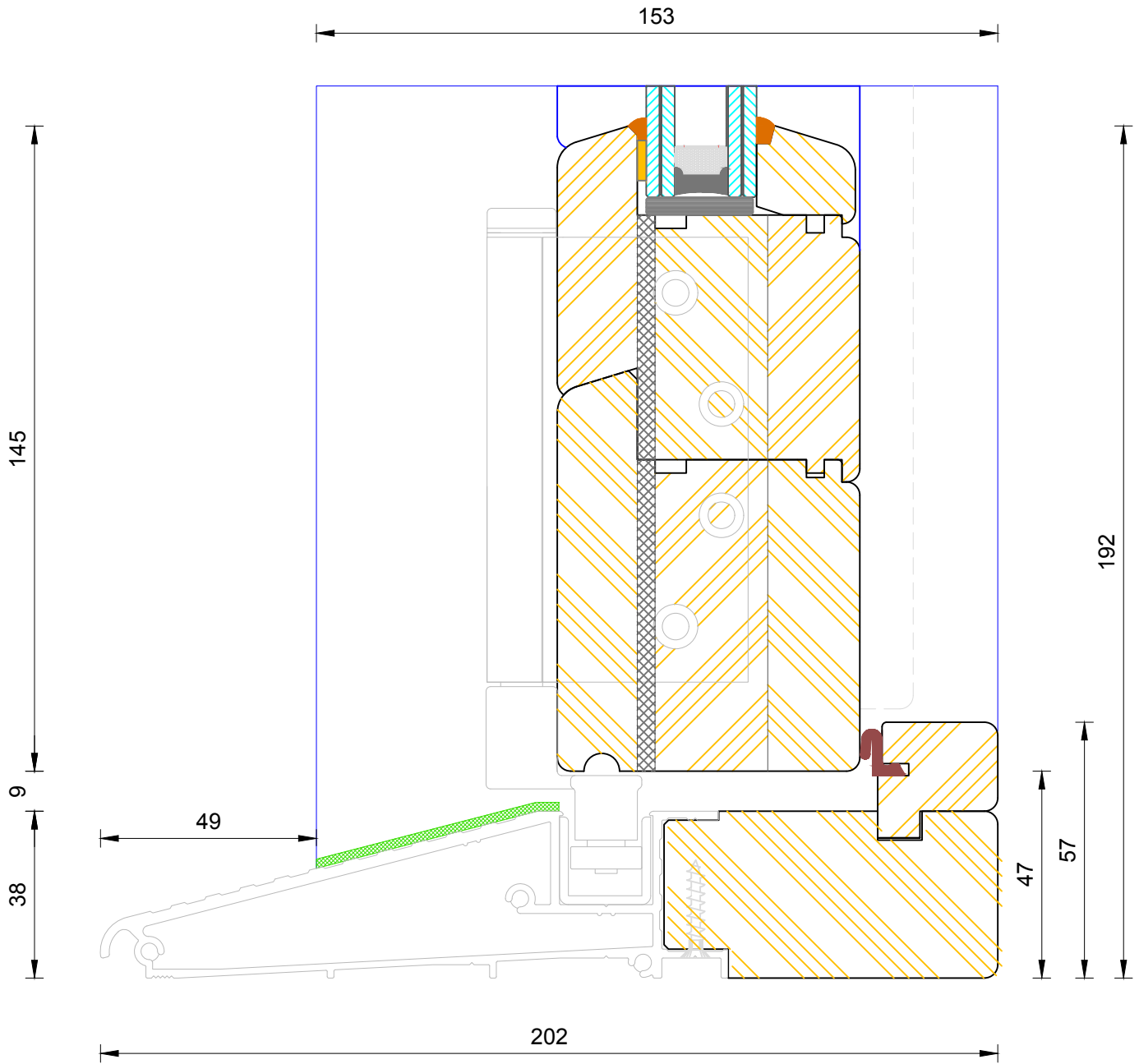

**Contemporary Open Out Folding Sliding Door
Aluminium Thresh**

DIMENSIONS	PLOT SIZE	SCALE	DATE	REV	DWG NO.
MM	A3	1:1	06.06.2012	A	4204

FO330 (AS) FO303 (OPP)

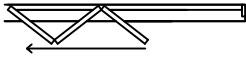
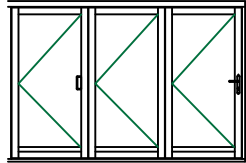

FO550 (AS) FO505 (OPP)

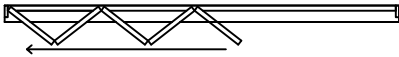
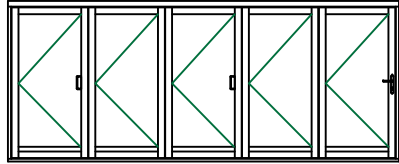

FO633 (AS) FO633 (OPP)

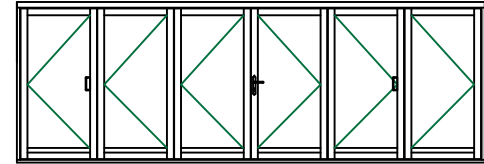

FO770 (AS) FO707 (OPP)

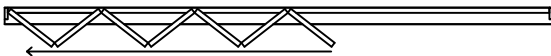
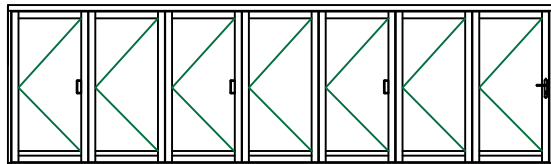

FO752 (AS) FO725 (OPP)

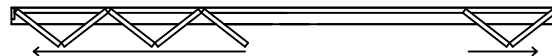
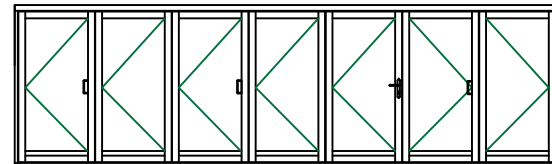

FO743 (AS) FO734 (OPP)

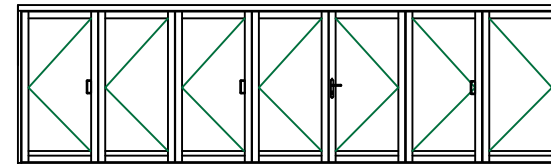

FO853 (AS) FO835 (OPP)

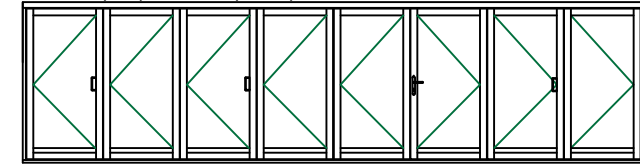

EXAMPLE SHOWN ON MODEL 330

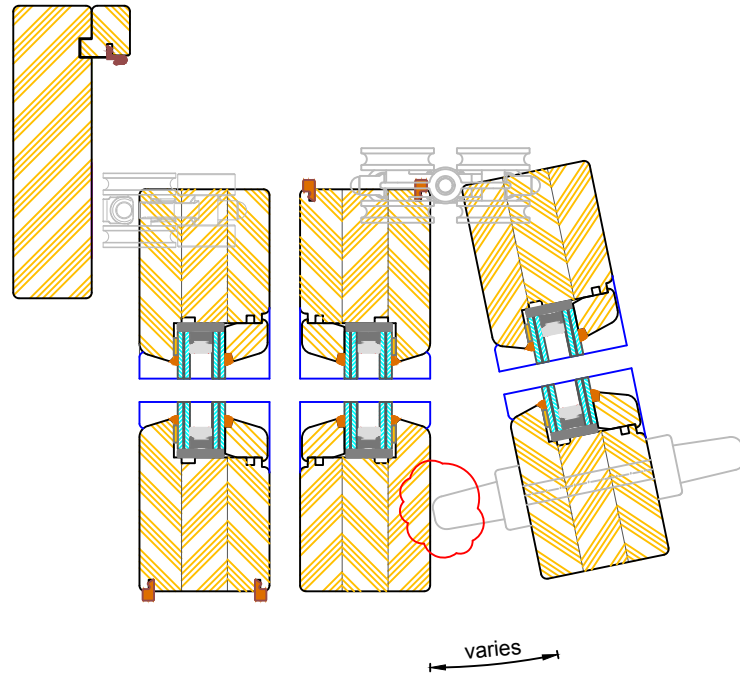

ANGLE VARIES DEPENDING ON DOOR WIDTH

Note:

Models 330,303,550,505,532,523,633,770,707,752,725,743,734,853,835

Have a traffic doors which include a lever handle to operate the high security locking system the doors are supplied with.

The type of handle used projects therefore care must be taken not to damage adjacent door leaves when concertained. Door stops and magnetic catches are available as an optional extra.

Alternative styles can be chosen without a traffic door leaf.



Open Out Folding Door - All Ranges
Traffic Door Handle Collision

DIMENSIONS	PLOT SIZE	SCALE	DATE	REV	DWG NO.
MM	A1	1:1	17.06.2014	A	4216

Please consider the environment before printing

ELEVATION VIEWED FROM OUTSIDE

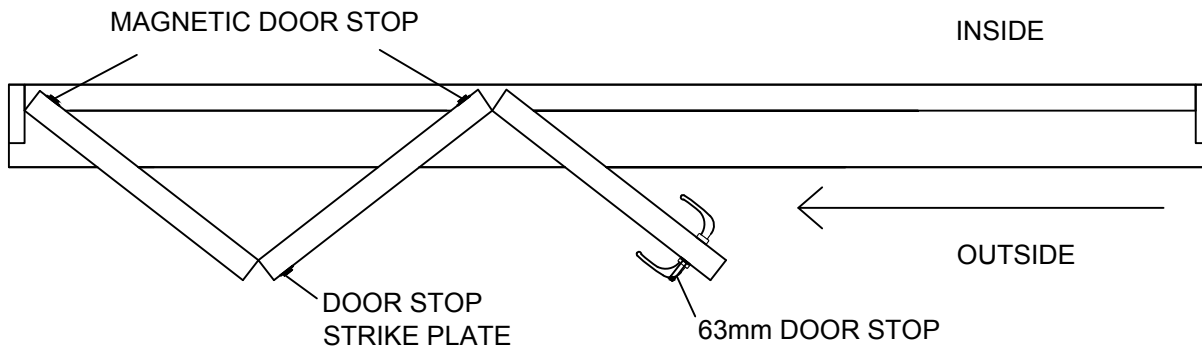
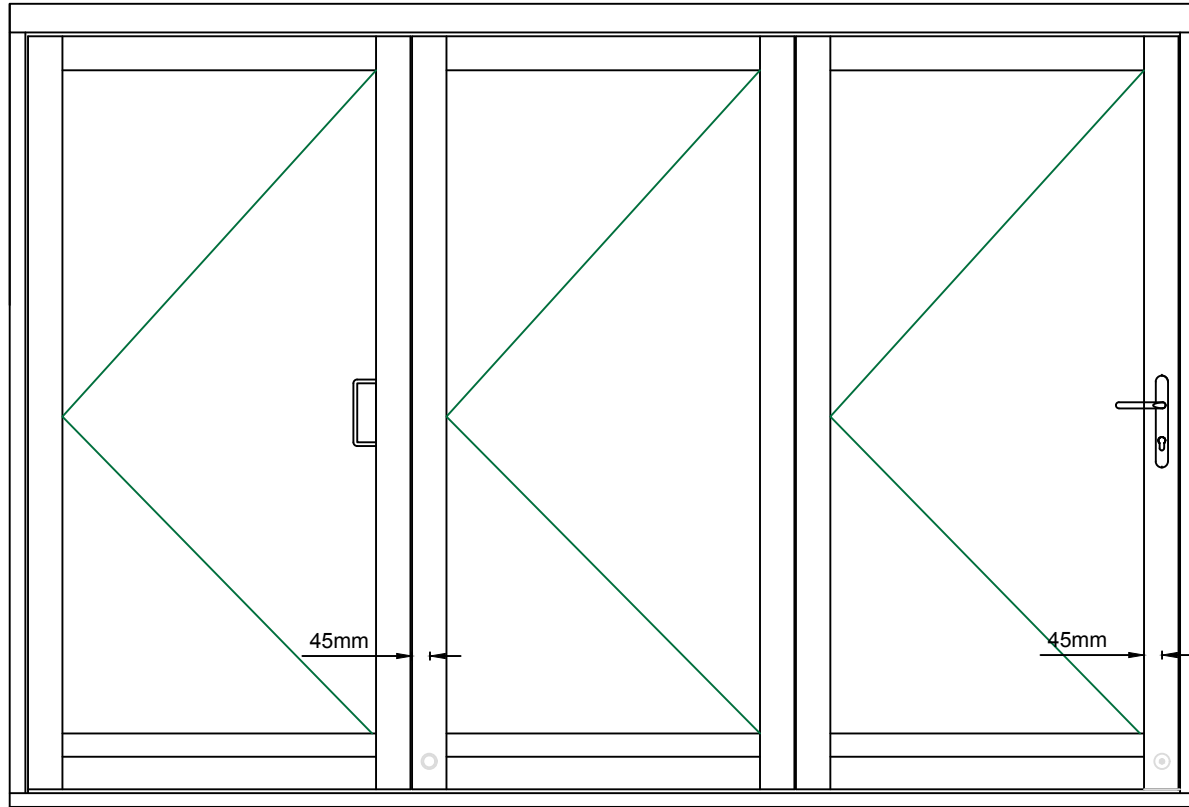

EXAMPLE SHOWN ON MODEL 330

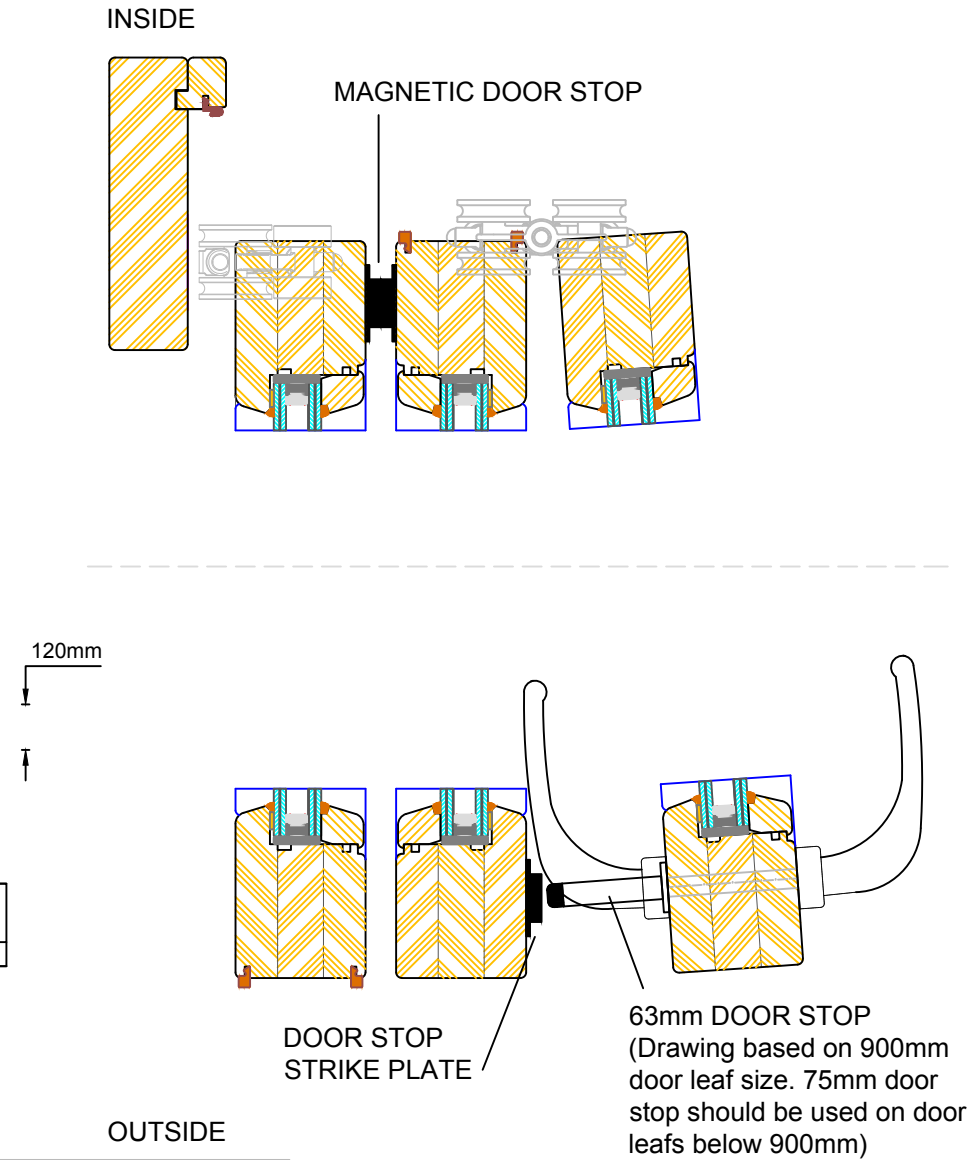

Open Out Folding Door - All Ranges
Optional Magnetic Catch & Door Stop Fitting Positions

DIMENSIONS	PLOT SIZE	SCALE	DATE	REV	DWG NO.
MM	A1	1:1	26.06.2014	A	4217

Please consider the environment before printing