

16

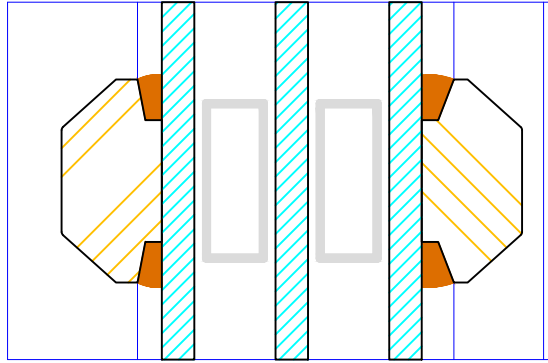

25

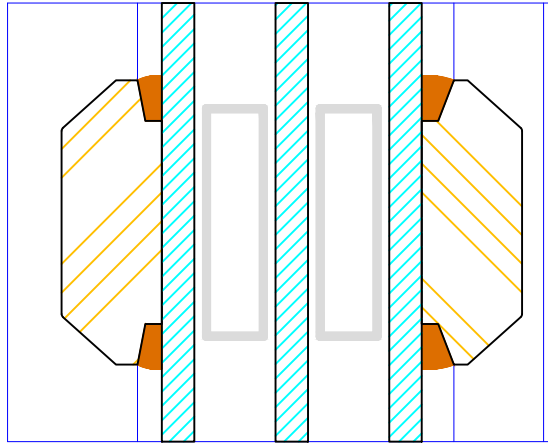

35

60 (varies min 60 / max 110mm)

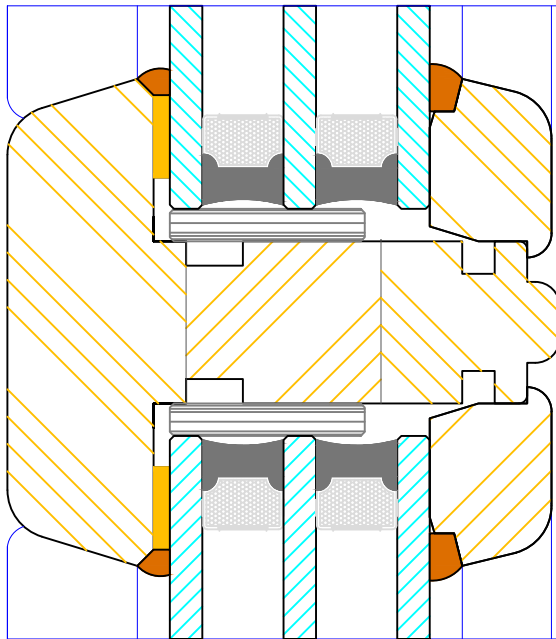

22
16
22

68



Contemporary Open Out Folding Sliding Door
Triple Glazed - Bar Options

DIMENSIONS	PLOT SIZE	SCALE	DATE	REV	DWG NO.
MM	A4	1:1	14.05.2014	A	4220
Please consider the environment before printing					

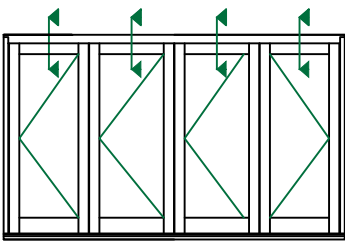
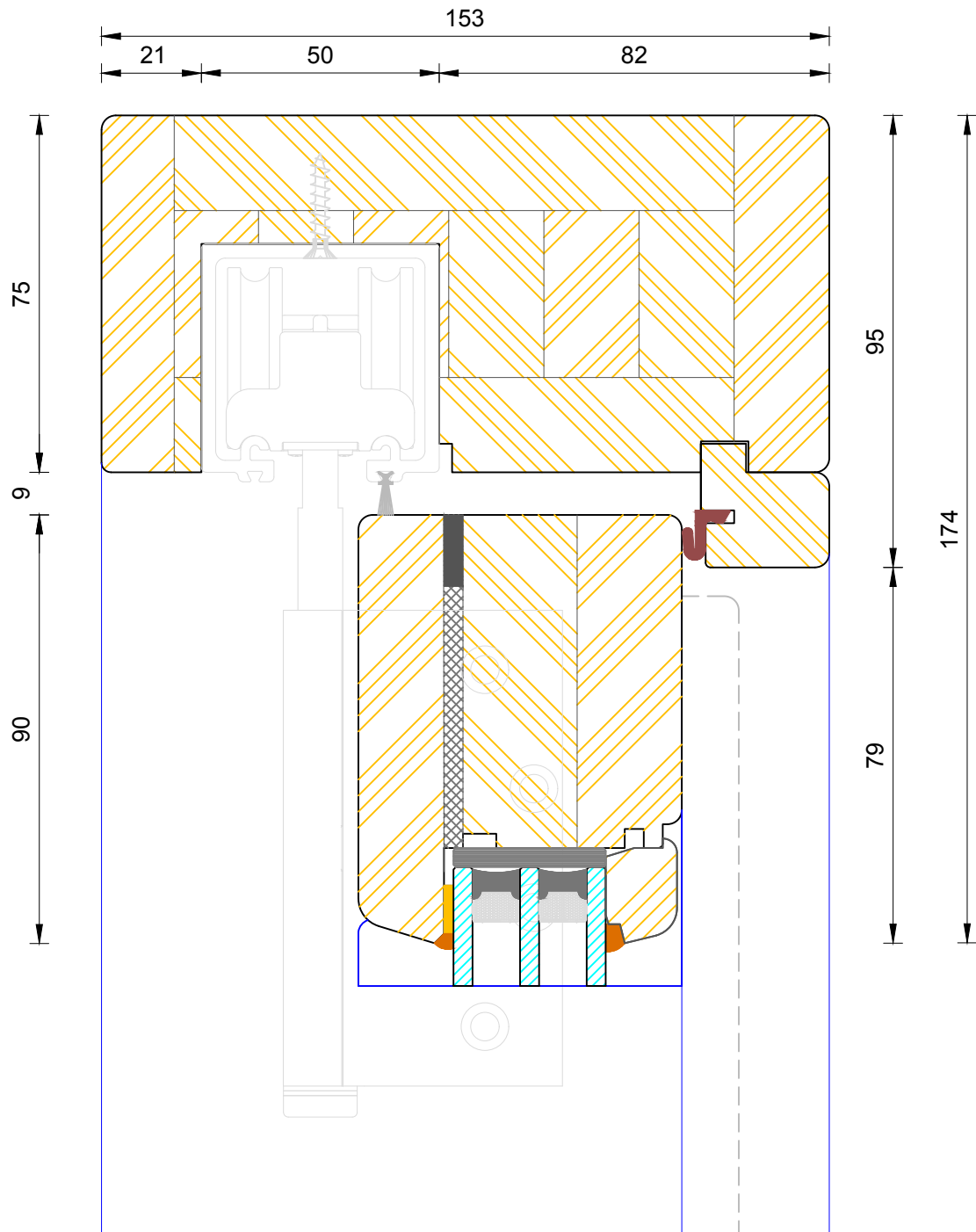

Contemporary Open Out Folding Sliding Door
Triple Glazed - Frame & Leaf Head (Without Vent)

DIMENSIONS	PLOT SIZE	SCALE	DATE	REV	DWG NO.
MM	A3	1:1	14.05.2014	A	4221

Please consider the environment before printing

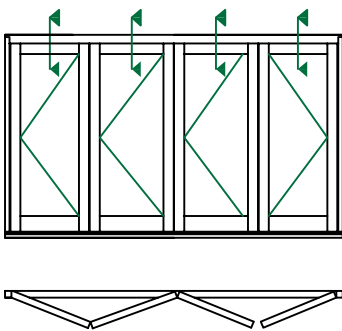
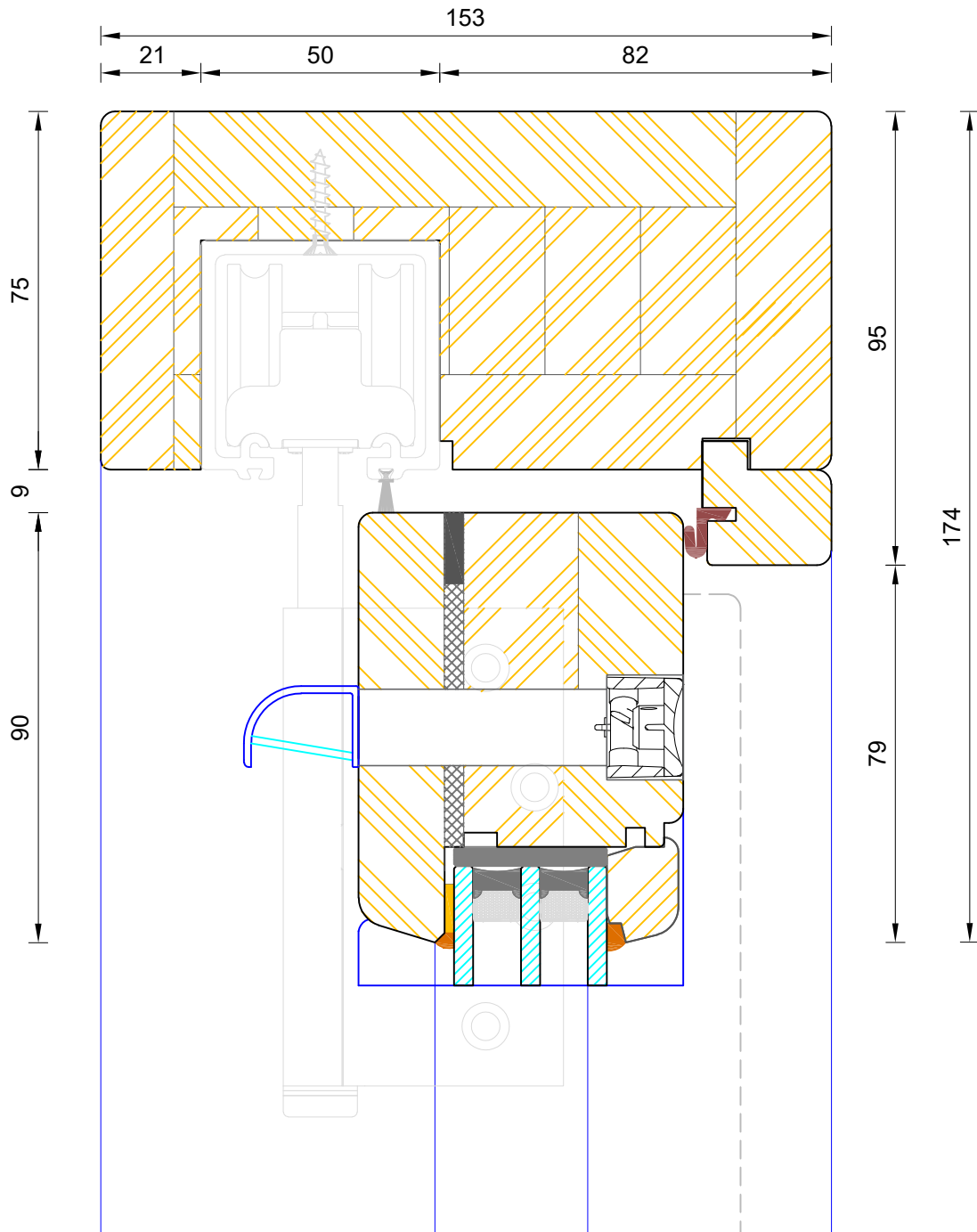

Model Numbers	Vent Location (Leaves from left to right)
ALL 2 LEAF MODELS	1 & 2
330 / 303	1 (330) 3 (303)
321 / 313	1 & 3
ALL 4 LEAF MODELS	1 & 4
550 / 505	1 (550) 5 (505)
541 / 514 / 532 / 523	1 & 5
ALL 6 LEAF MODELS	1 & 6
770 / 707	1 (770) 7 (707)
761 / 716 / 752 / 725 / 743 / 734	1 & 7
ALL 8 LEAF MODELS	1 & 8



Contemporary Open Out Folding Sliding Door
Triple Glazed - Frame & Leaf Head (With Vent)

DIMENSIONS	PLOT SIZE	SCALE	DATE	REV	DWG NO.
MM	A3	1:1	04.07.2022	B	4222

Please consider the environment before printing

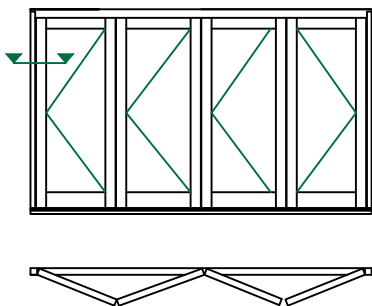
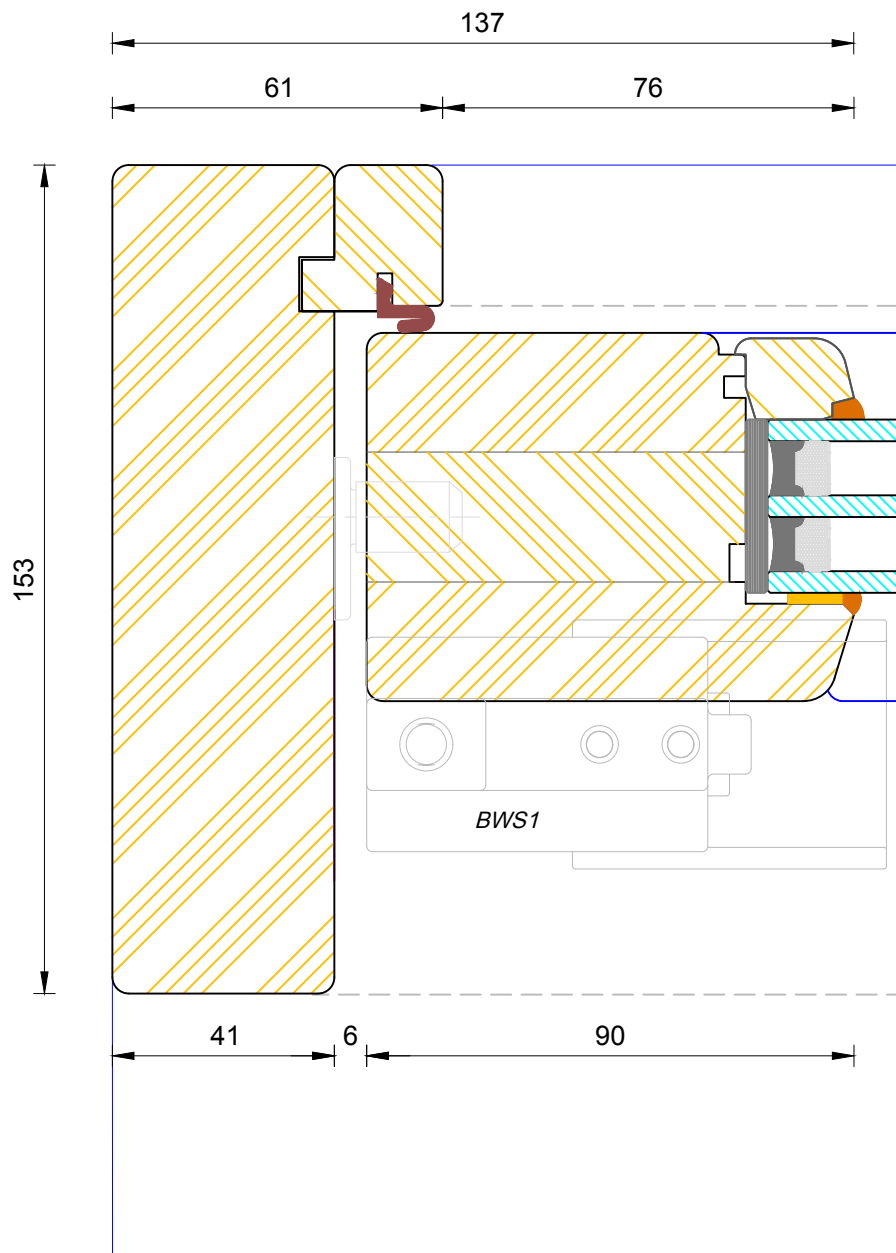

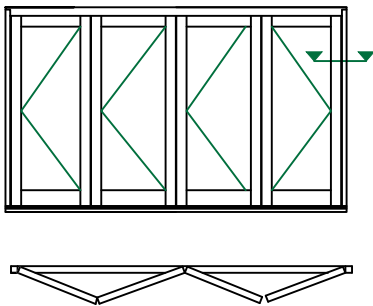
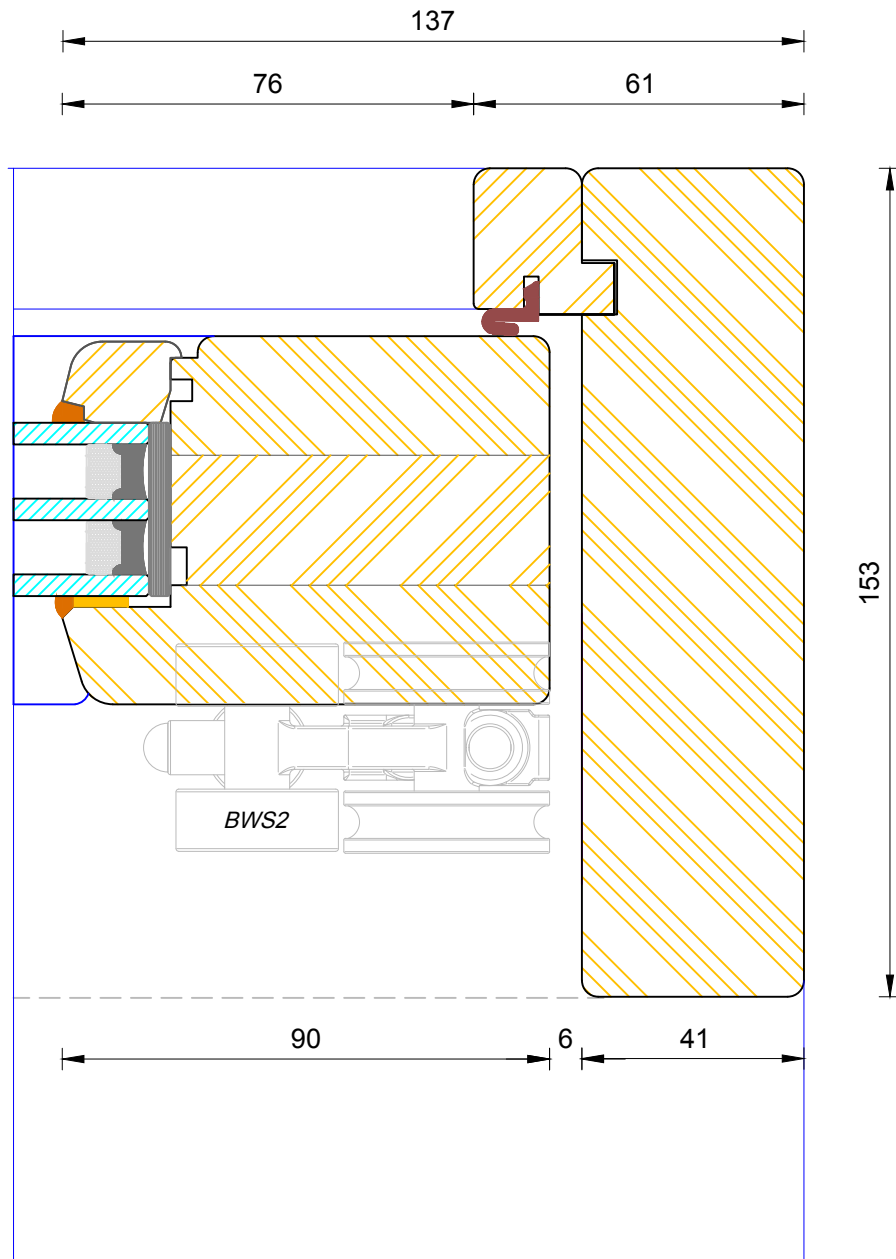

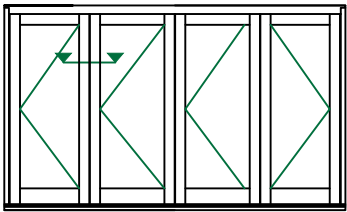
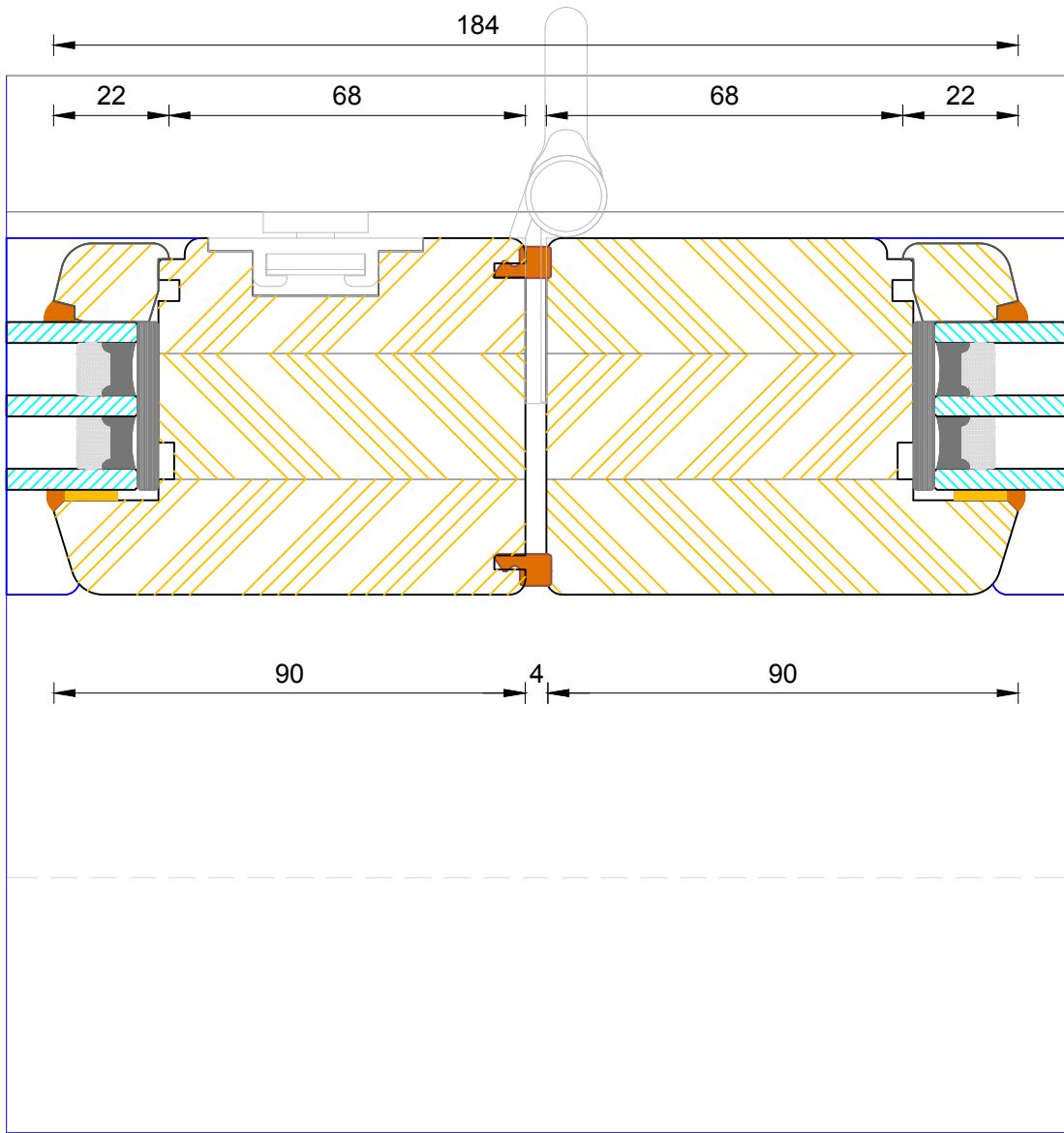

Contemporary Open Out Folding Sliding Door
Triple Glazed - Flying Mullion Hinge Handle

DIMENSIONS	PLOT SIZE	SCALE	DATE	REV	DWG NO.
MM	A3	1:1	14.05.2014	A	4228

Please consider the environment before printing

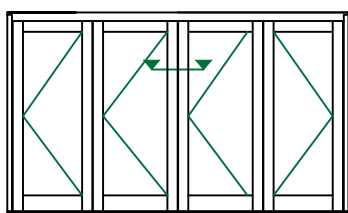
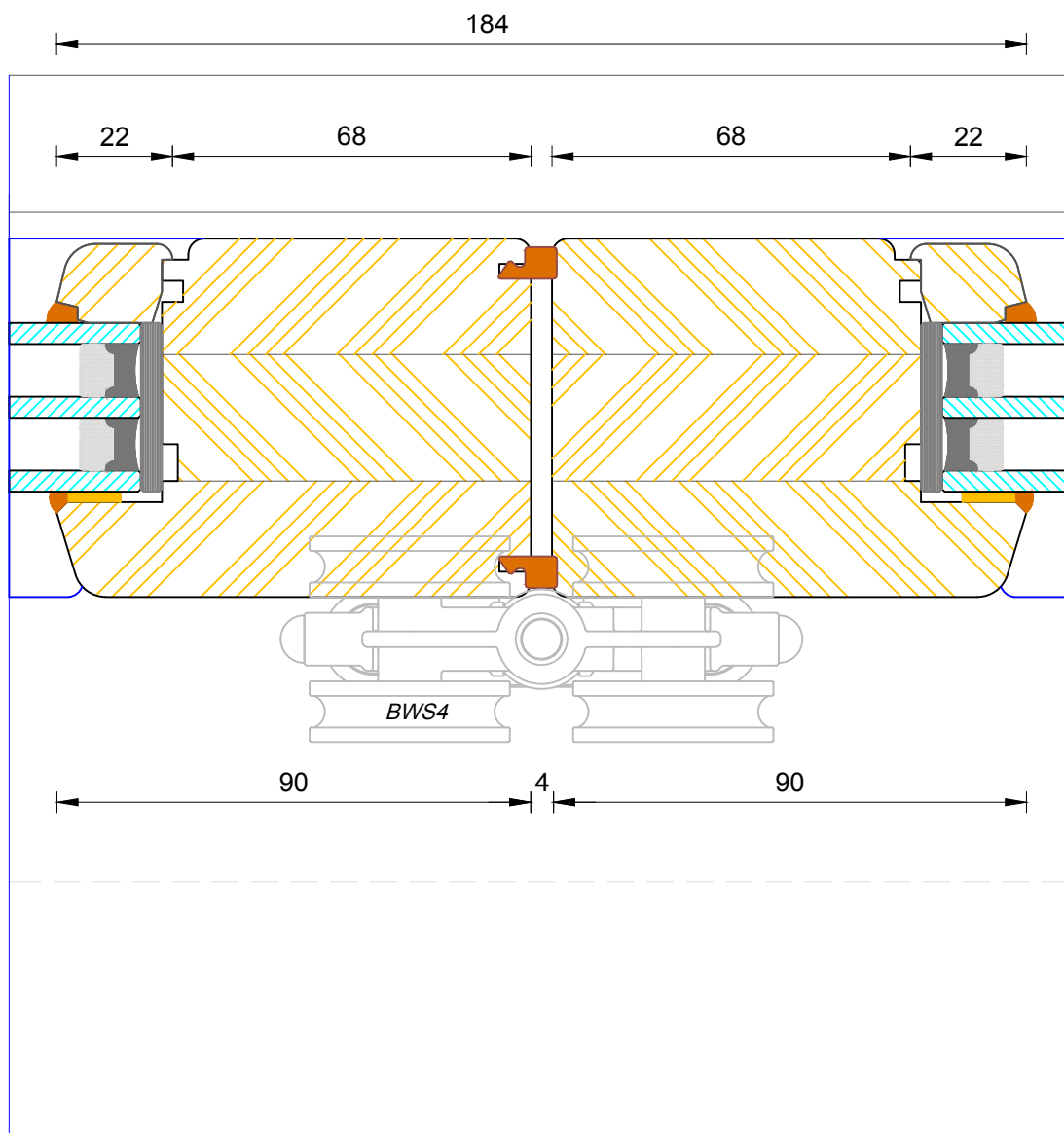

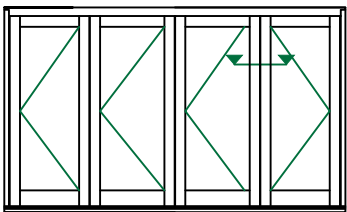
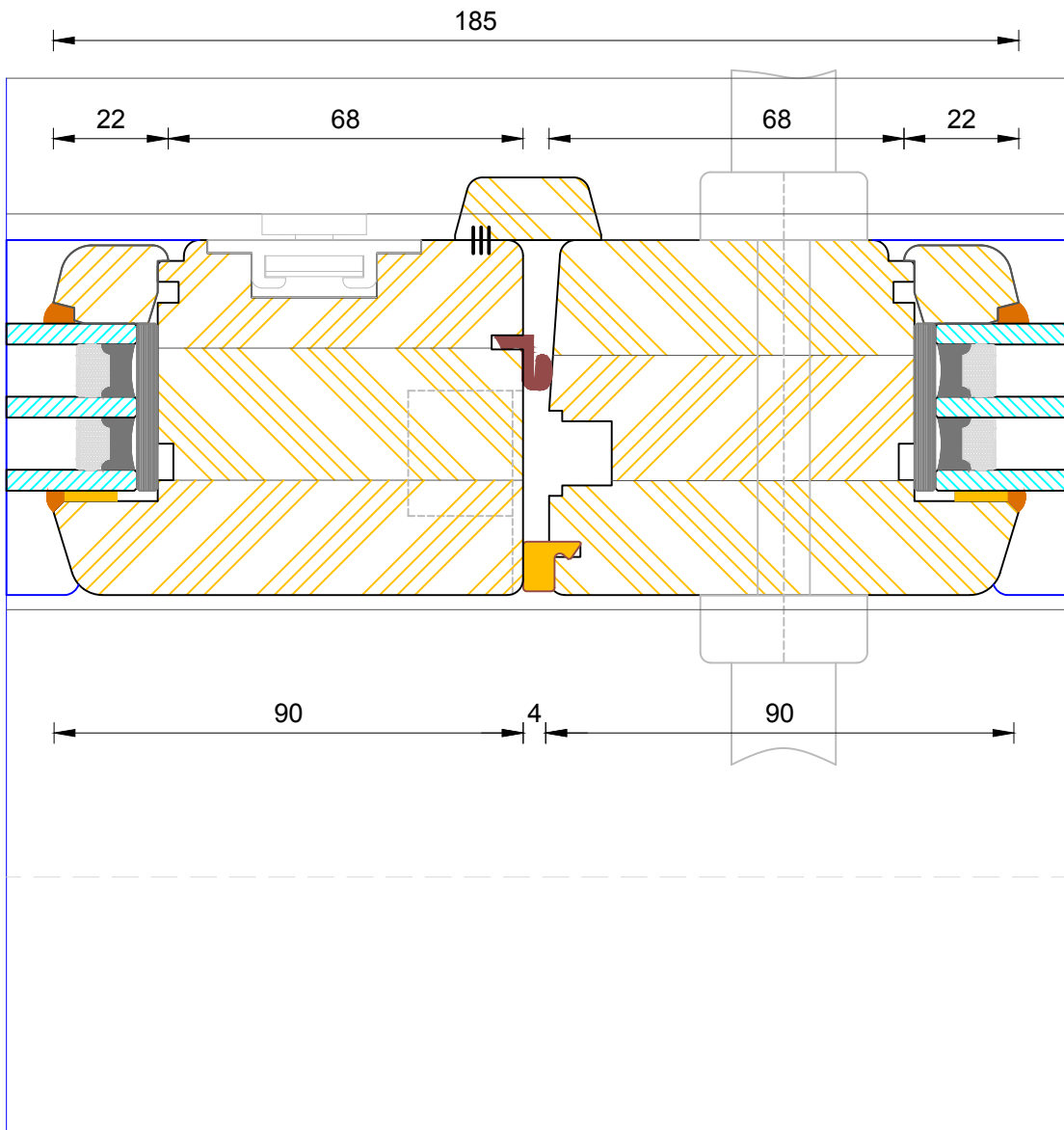

Contemporary Open Out Folding Sliding Door
Triple Glazed - Flying Mullion Handle

DIMENSIONS	PLOT SIZE	SCALE	DATE	REV	DWG NO.
MM	A3	1:1	14.05.2014	A	4230

Please consider the environment before printing

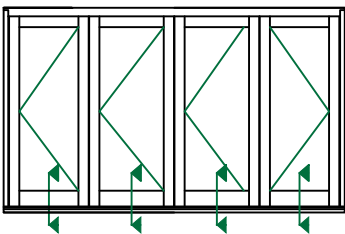
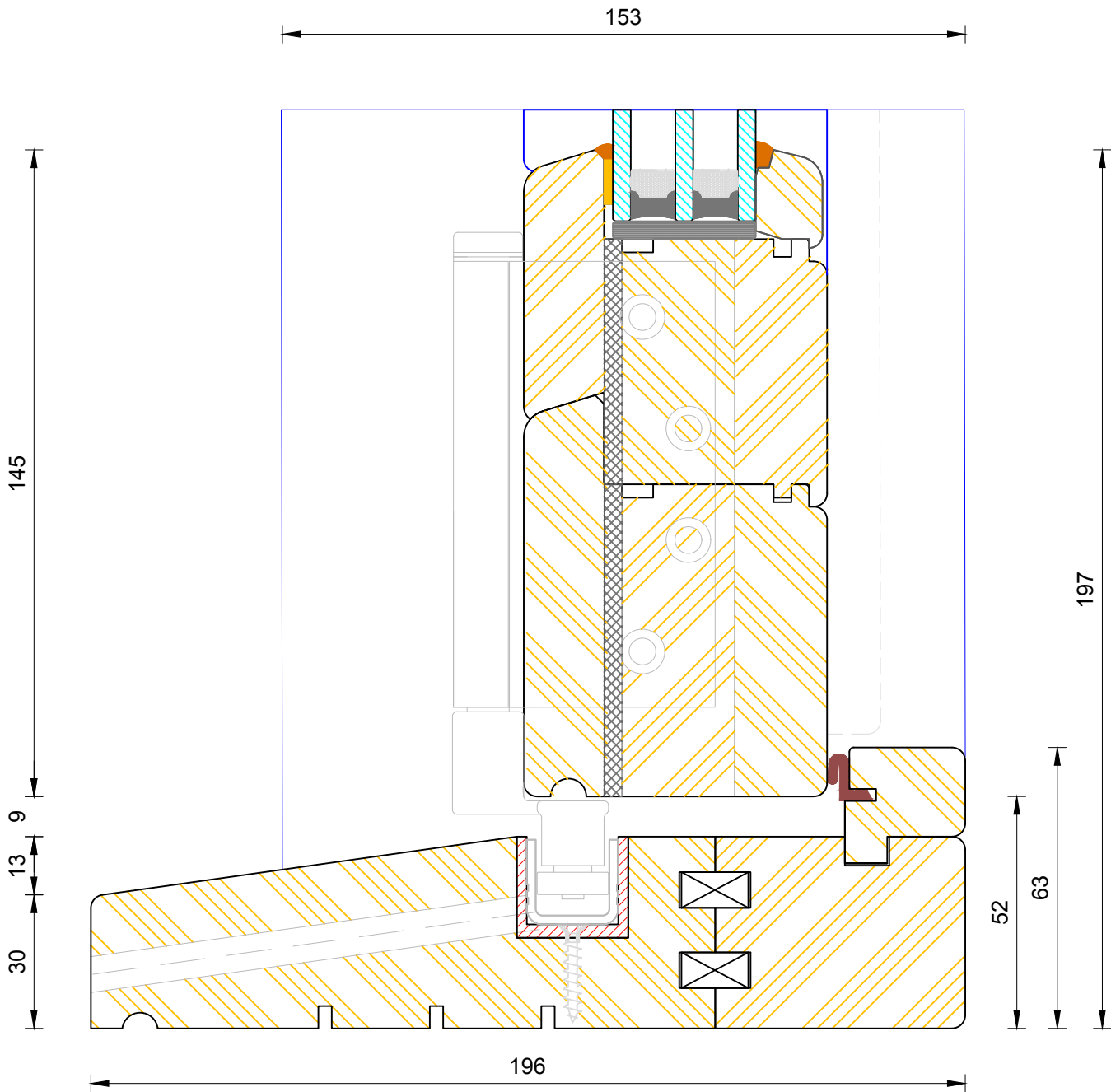

Contemporary Open Out Folding Sliding Door
Triple Glazed - Timber Thresh

DIMENSIONS	PLOT SIZE	SCALE	DATE	REV	DWG NO.
MM	A3	1:1	14.05.2014	A	4223

Please consider the environment before printing

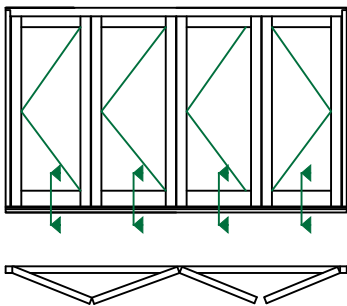
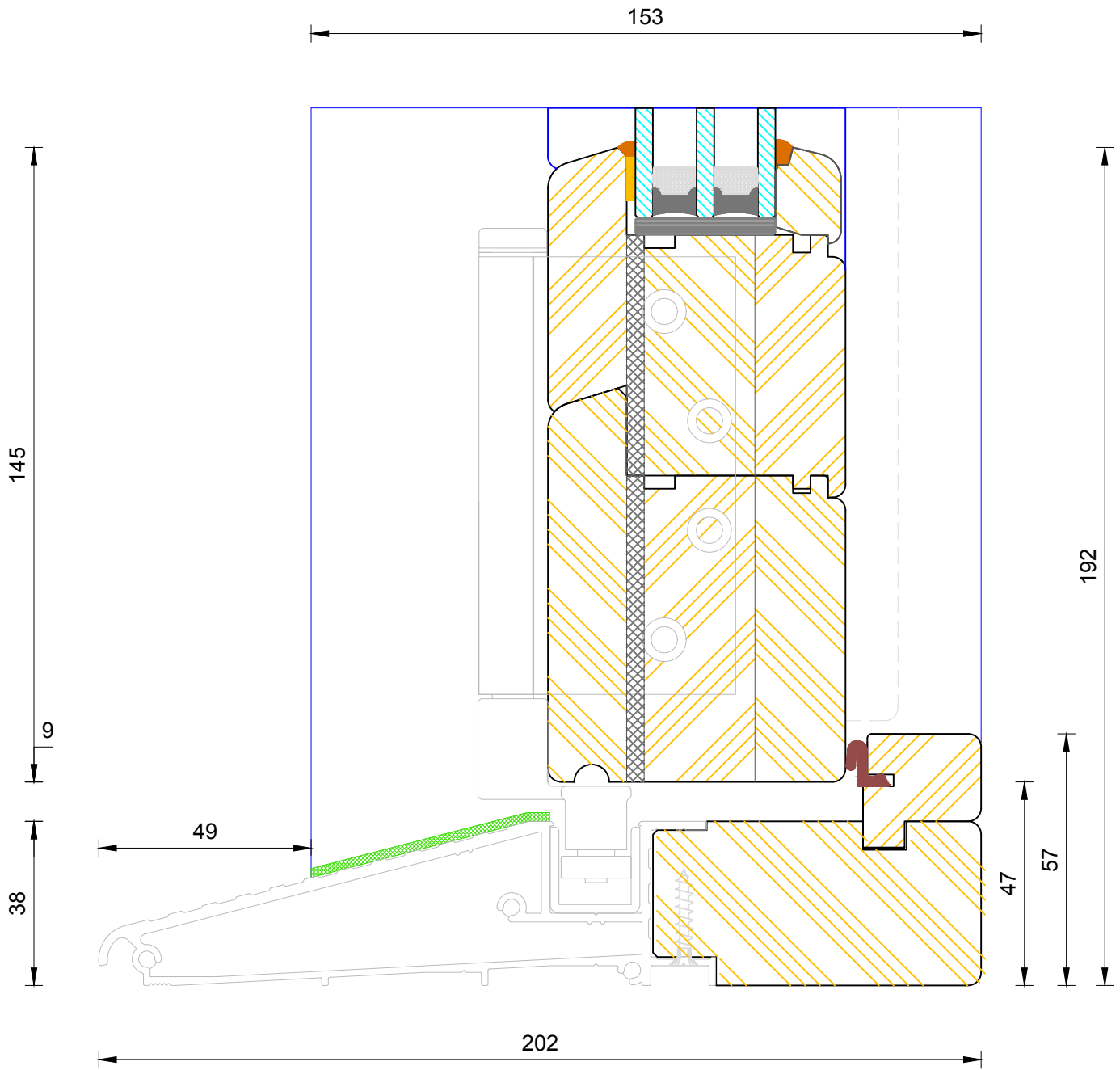

Contemporary Open Out Folding Sliding Door
Triple Glazed - Aluminium Thresh

DIMENSIONS	PLOT SIZE	SCALE	DATE	REV	DWG NO.
MM	A3	1:1	14.05.2014	A	4225

Please consider the environment before printing