

**Bereco**

**Traditional Open Out Folding Sliding Door  
Bar Options**

DIMENSIONS	PLOT SIZE	SCALE	DATE	REV	DWG NO.
MM	A4	1:1	01.01.2019	B	<b>4302</b>

Please consider the environment before printing

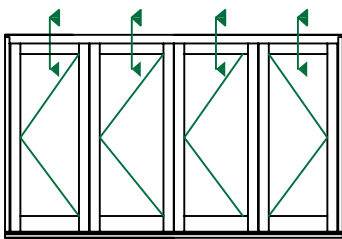
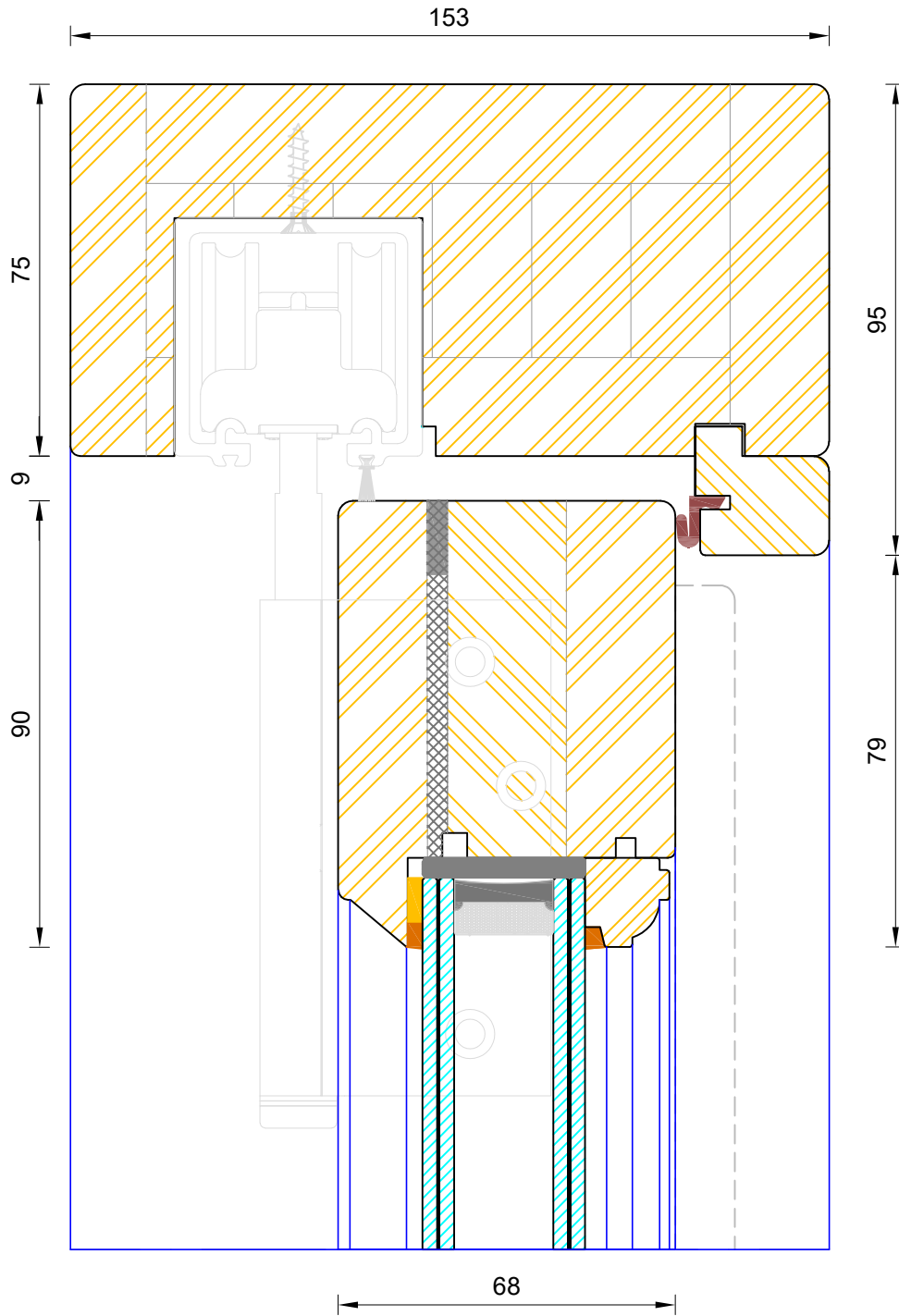

**Traditional Open Out Folding Sliding Door  
Frame & Leaf Head (Without Vent)**

DIMENSIONS	PLOT SIZE	SCALE	DATE	REV	DWG NO.
MM	A3	1:1	03.08.2022	B	<b>4305</b>

Please consider the environment before printing

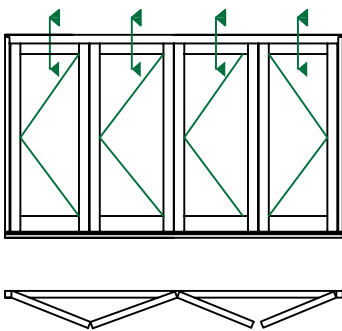
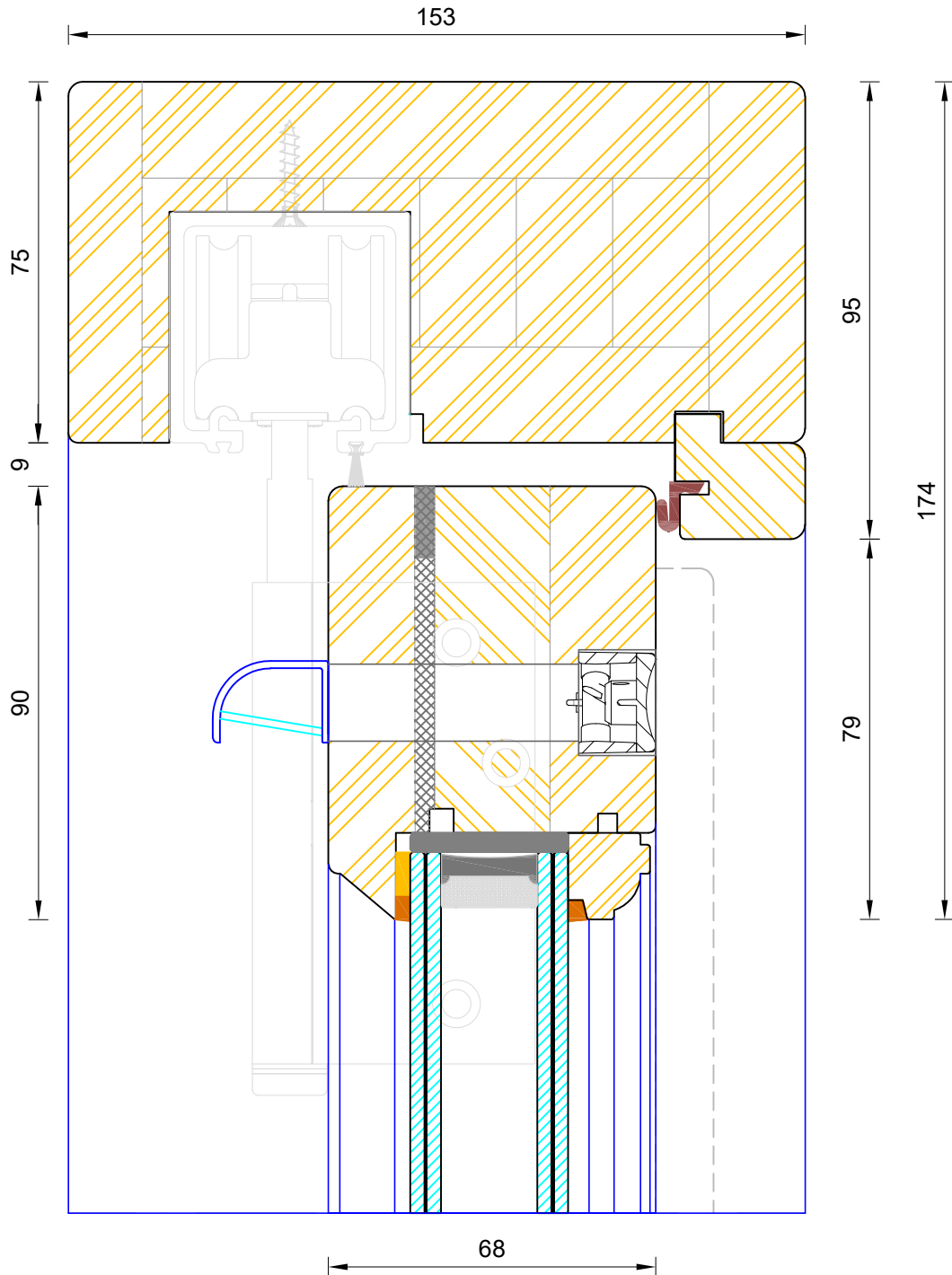

Model Numbers	Vent Location (Leaves from left to right)
ALL 2 LEAF MODELS	1 & 2
330 / 303	1 (330) 3 (303)
321 / 313	1 & 3
ALL 4 LEAF MODELS	1 & 4
550 / 505	1 (550) 5 (505)
541 / 514 / 532 / 523	1 & 5
ALL 6 LEAF MODELS	1 & 6
770 / 707	1 (770) 7 (707)
761 / 716 / 752 / 725 / 743 / 734	1 & 7
ALL 8 LEAF MODELS	1 & 8



### Traditional Open Out Folding Sliding Door Frame & Leaf Head (With Vent)

DIMENSIONS	PLOT SIZE	SCALE	DATE	REV	DWG NO.
MM	A3	1:1	03.08.2022	C	<b>4305.1</b>

Please consider the environment before printing

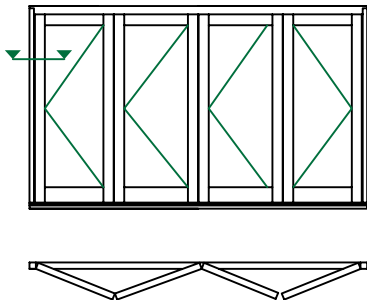
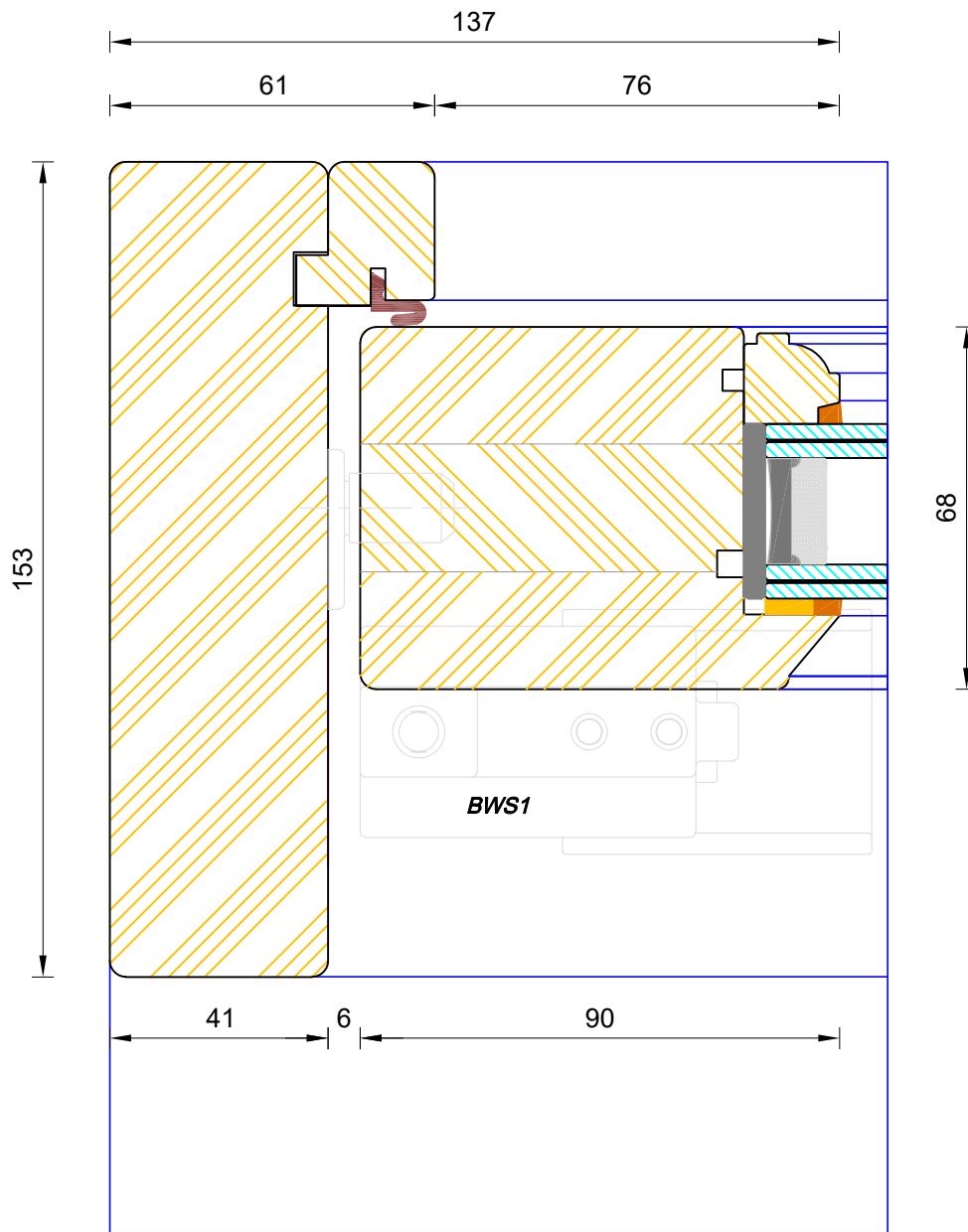

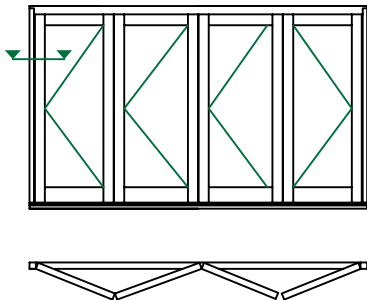
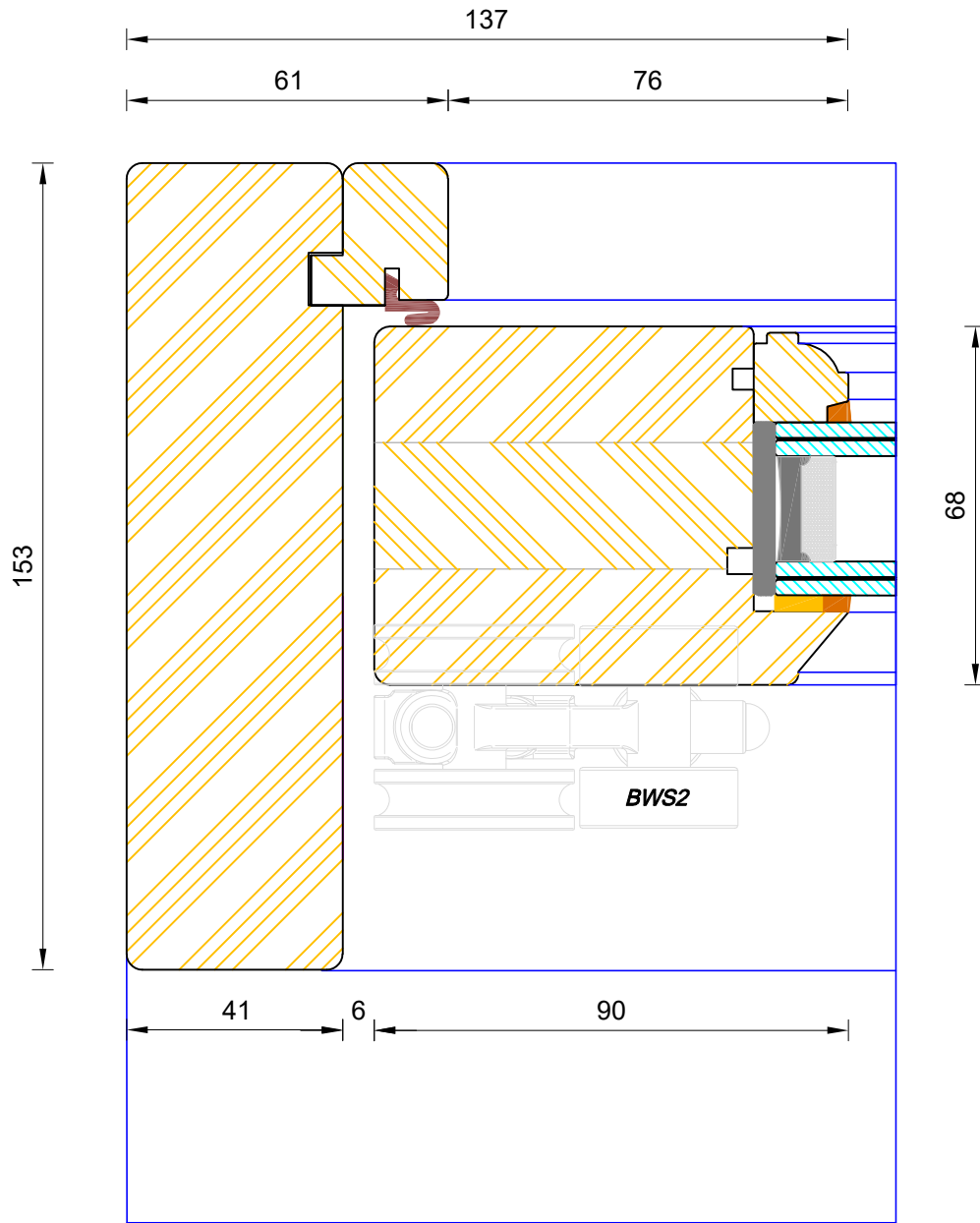

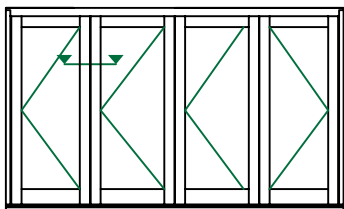
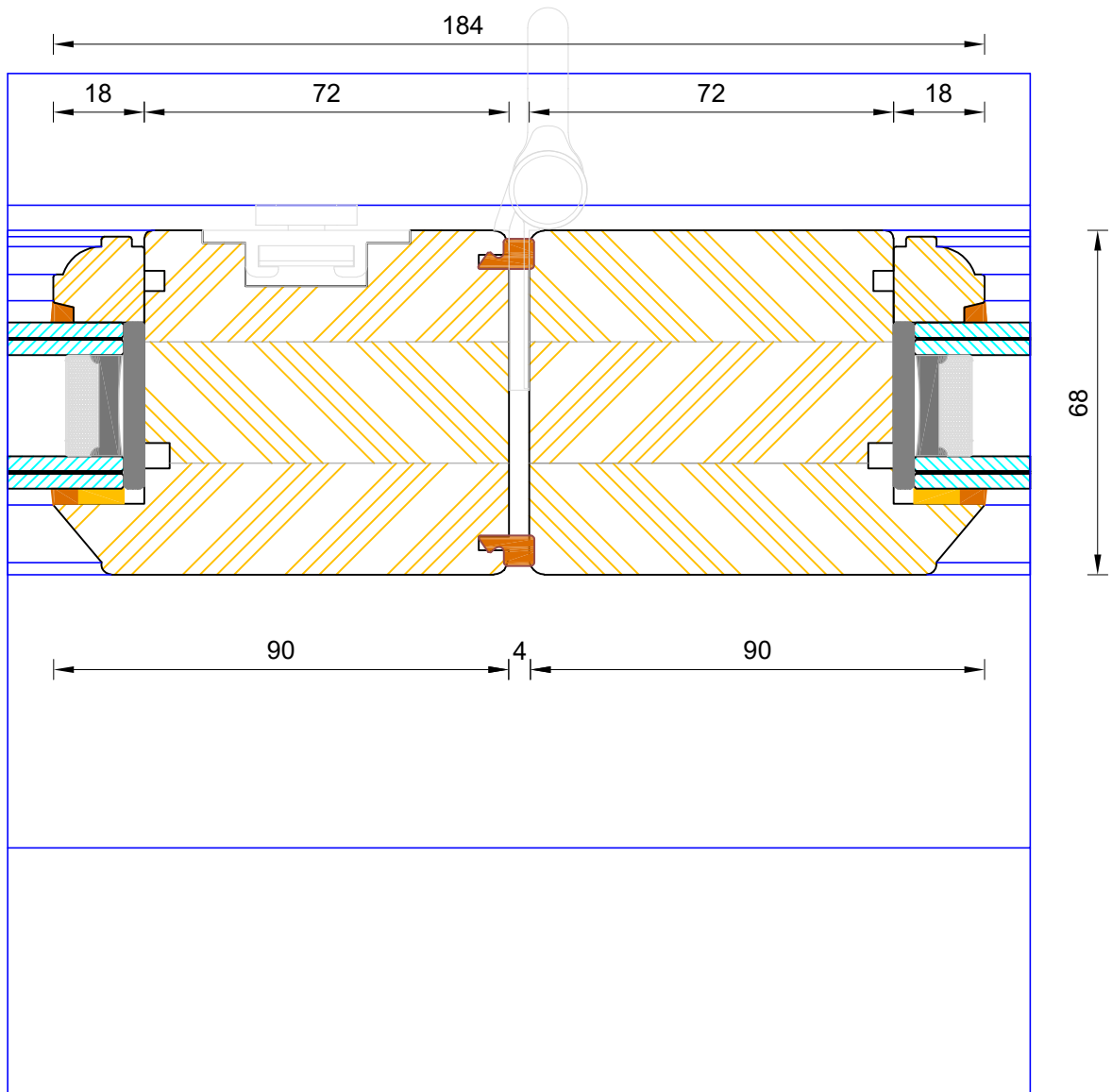

**Traditional Open Out Folding Sliding Door**  
Flying Mullion Hinge Handle

DIMENSIONS	PLOT SIZE	SCALE	DATE	REV	DWG NO.
MM	A3	1:1	03.08.2022	B	<b>4308</b>

Please consider the environment before printing

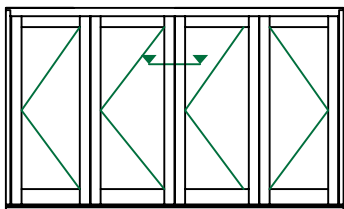
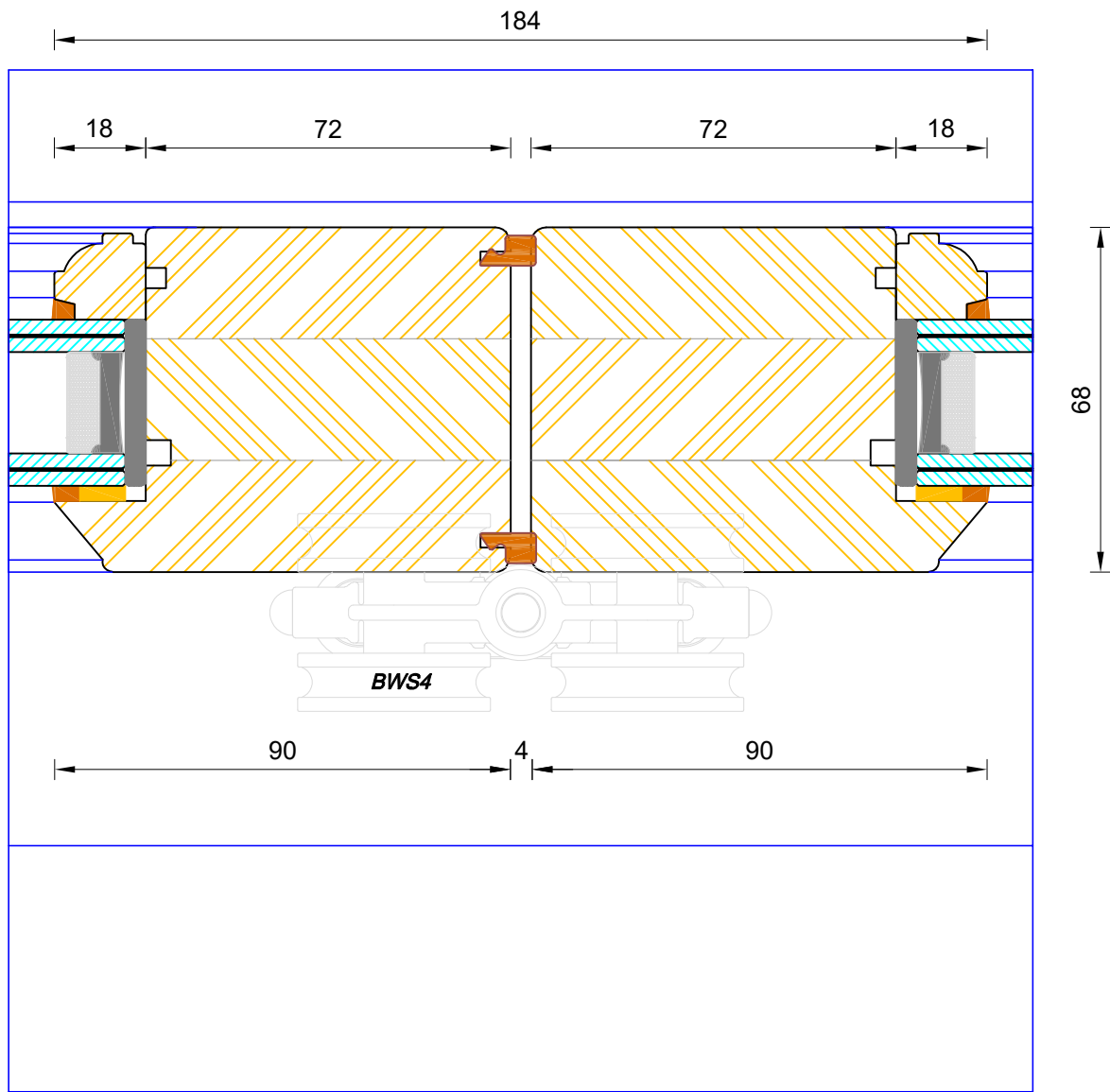

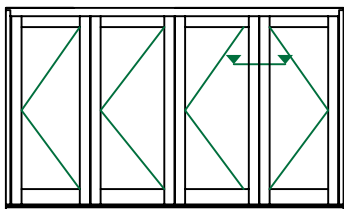
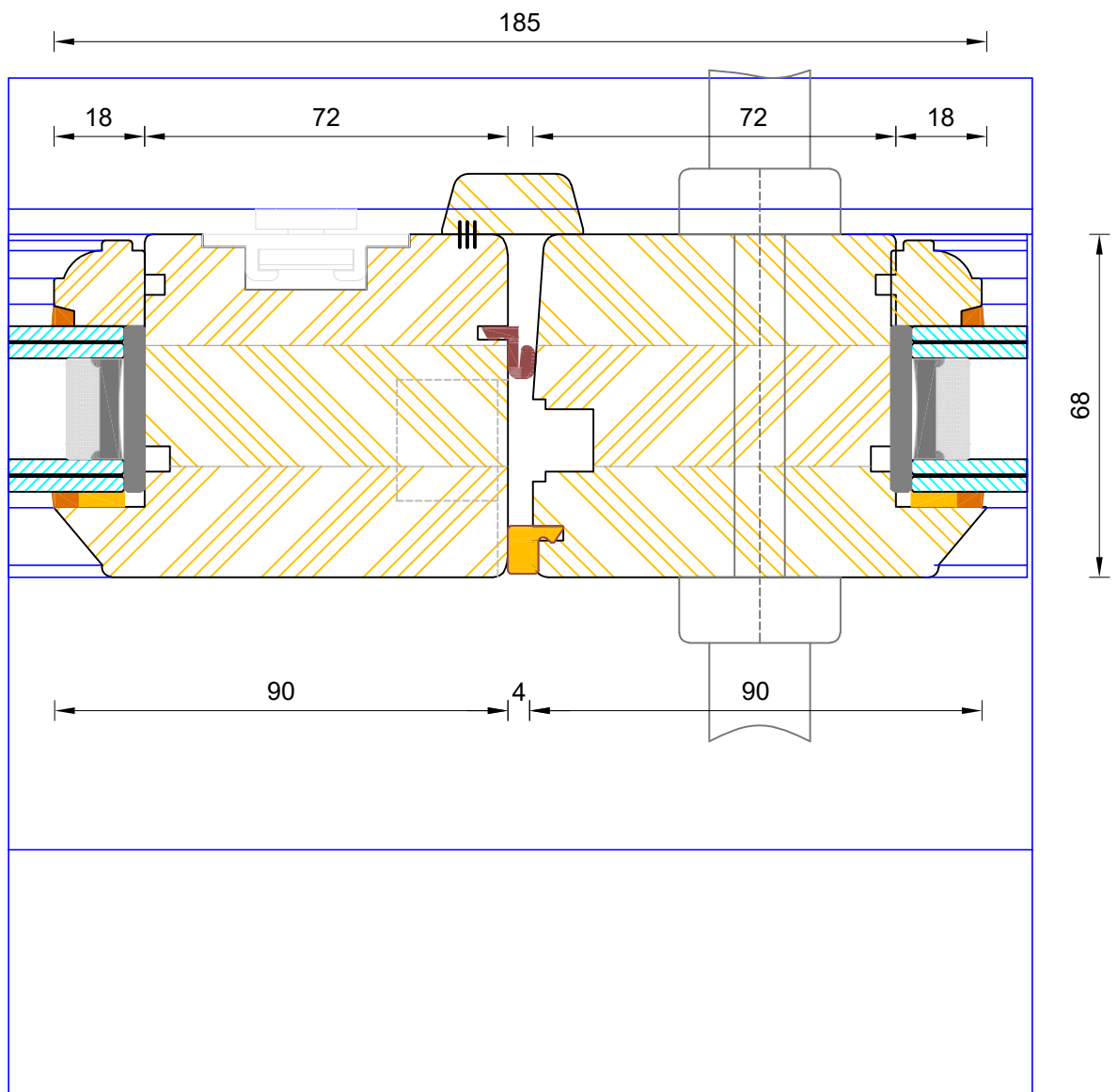

**Traditional Open Out Folding Sliding Door**  
**Flying Mullion Handle**

DIMENSIONS	PLOT SIZE	SCALE	DATE	REV	DWG NO.
MM	A3	1:1	03.08.2022	B	<b>4310</b>

Please consider the environment before printing



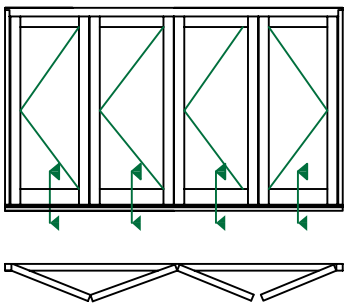
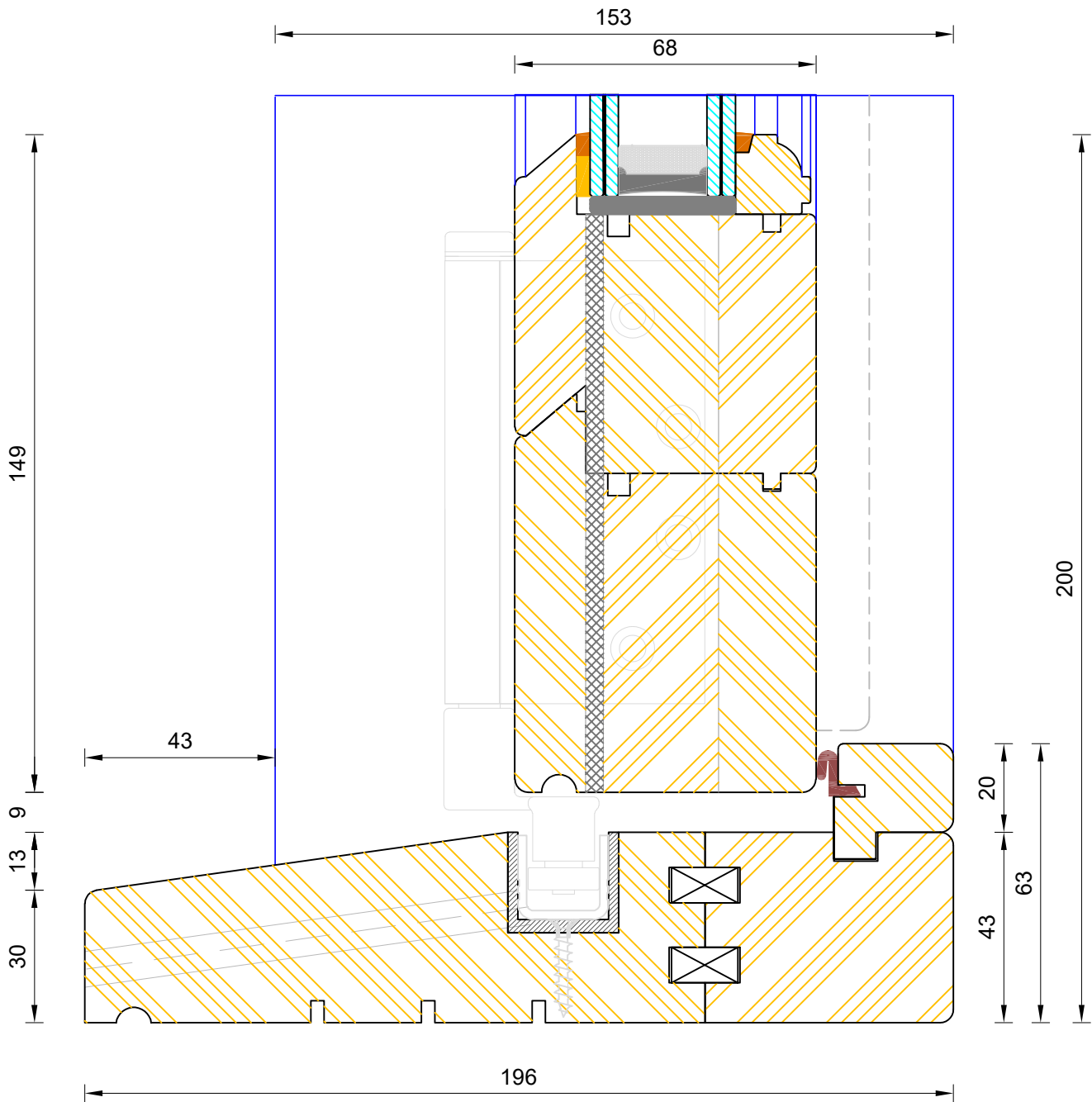

**Traditional Open Out Folding Sliding Door  
Timber Thresh**

DIMENSIONS	PLOT SIZE	SCALE	DATE	REV	DWG NO.
MM	A3	1:1	03.08.2022	B	<b>4303</b>

 Please consider the environment before printing

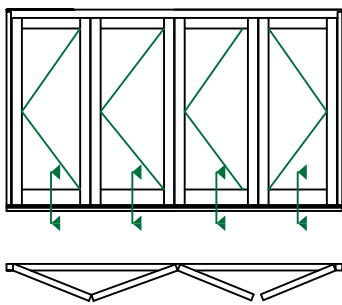
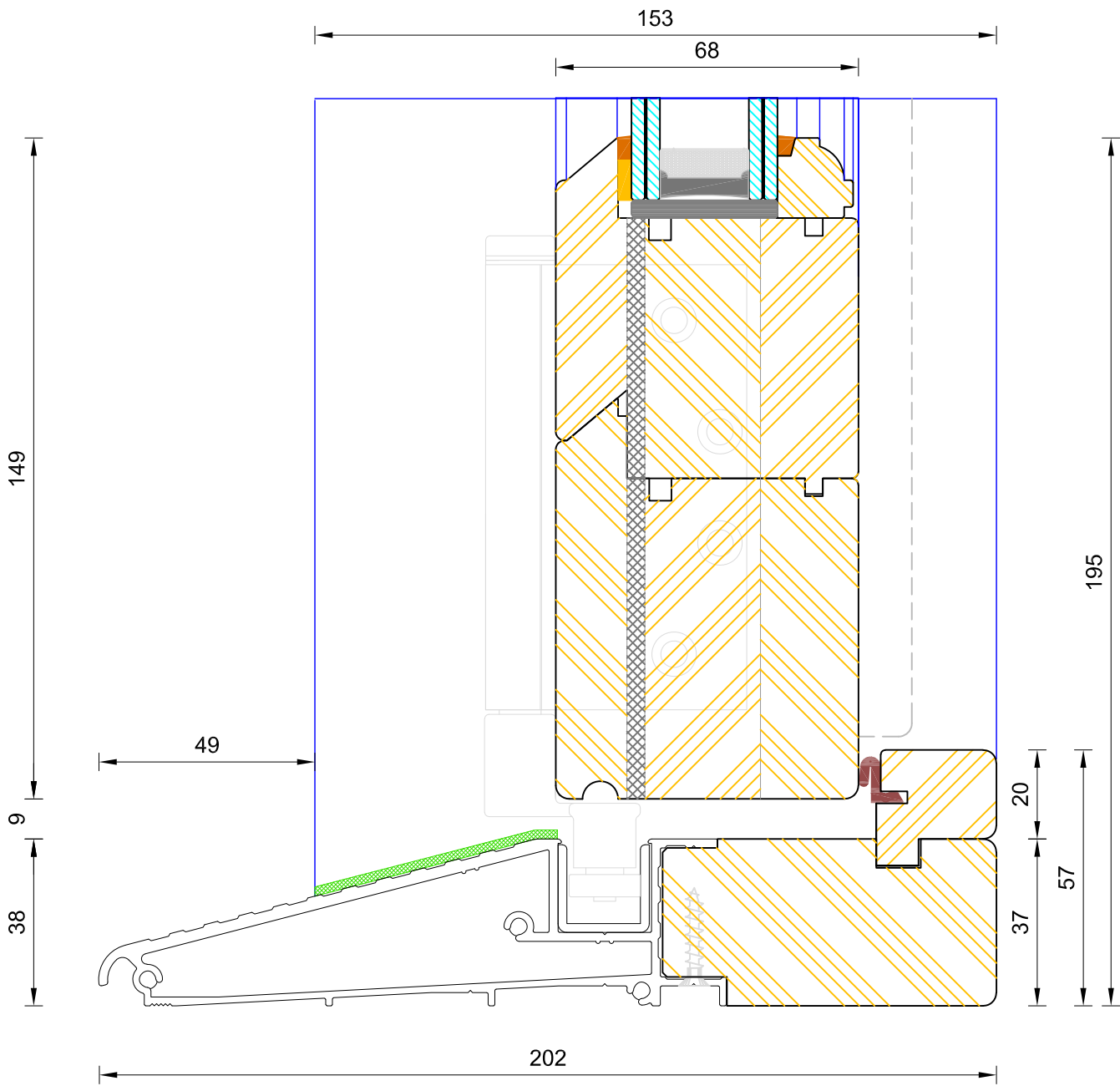

**Traditional Open Out Folding Sliding Door  
Aluminium Thresh**

DIMENSIONS	PLOT SIZE	SCALE	DATE	REV	DWG NO.
MM	A3	1:1	03.08.2022	B	<b>4304</b>
Please consider the environment before printing					

FO330 (AS) FO303 (OPP)

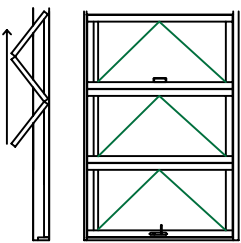

FO550 (AS) FO505 (OPP)

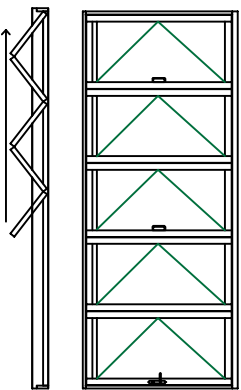

FO633 (AS) FO633 (OPP)

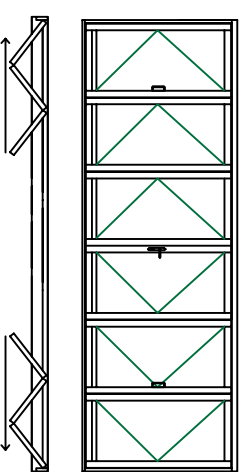

FO770 (AS) FO707 (OPP)

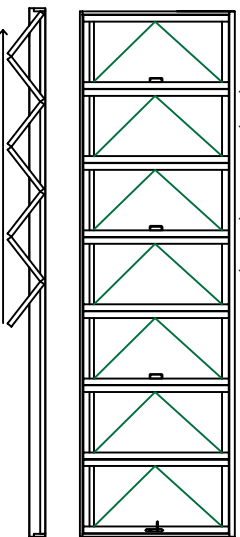

EXAMPLE SHOWN ON MODEL 330

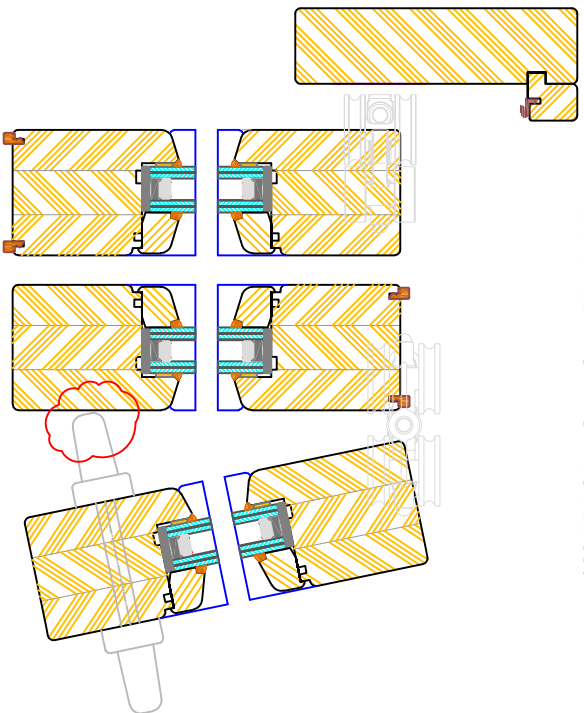

ANGLE VARIES DEPENDING ON DOOR WIDTH

**Note:**

**Models 330,303,550,505,532,523,633,770,707,752,725,743,734,853,835**

Have a traffic doors which include a lever handle to operate the high security locking system the doors are supplied with.

The type of handle used projects therefore care must be taken not to damage adjacent door leafs when concentrated. Door stops and magnetic catches are available as an optional extra.

Alternative styles can be chosen without a traffic door leaf.

FO752 (AS) FO725 (OPP)

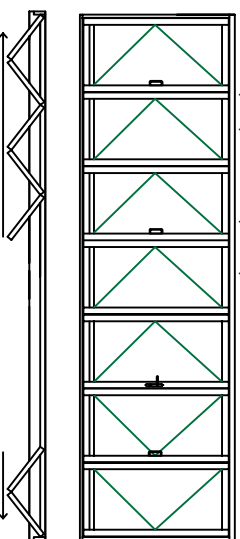

FO743 (AS) FO734 (OPP)

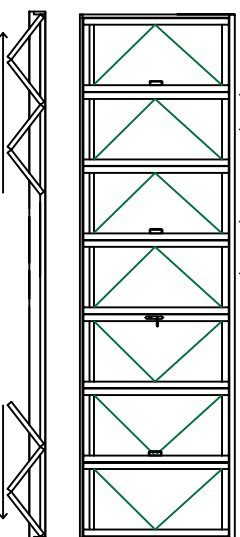

FO853 (AS) FO835 (OPP)

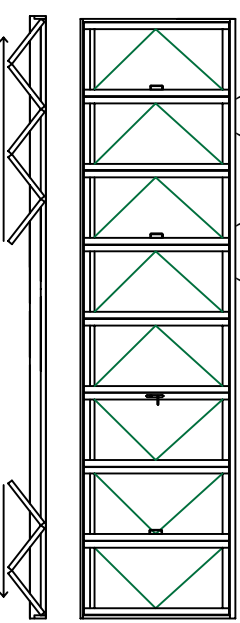

**Open Out Folding Door - All Ranges**  
**Traffic Door Handle Collision**

DIMENSIONS	PLOT SIZE	SCALE	DATE	REV	DWG NO.
MM	A0	1:1	17.06.2014	A	<b>4316</b>

Please consider the environment before printing

ELEVATION VIEWED FROM OUTSIDE

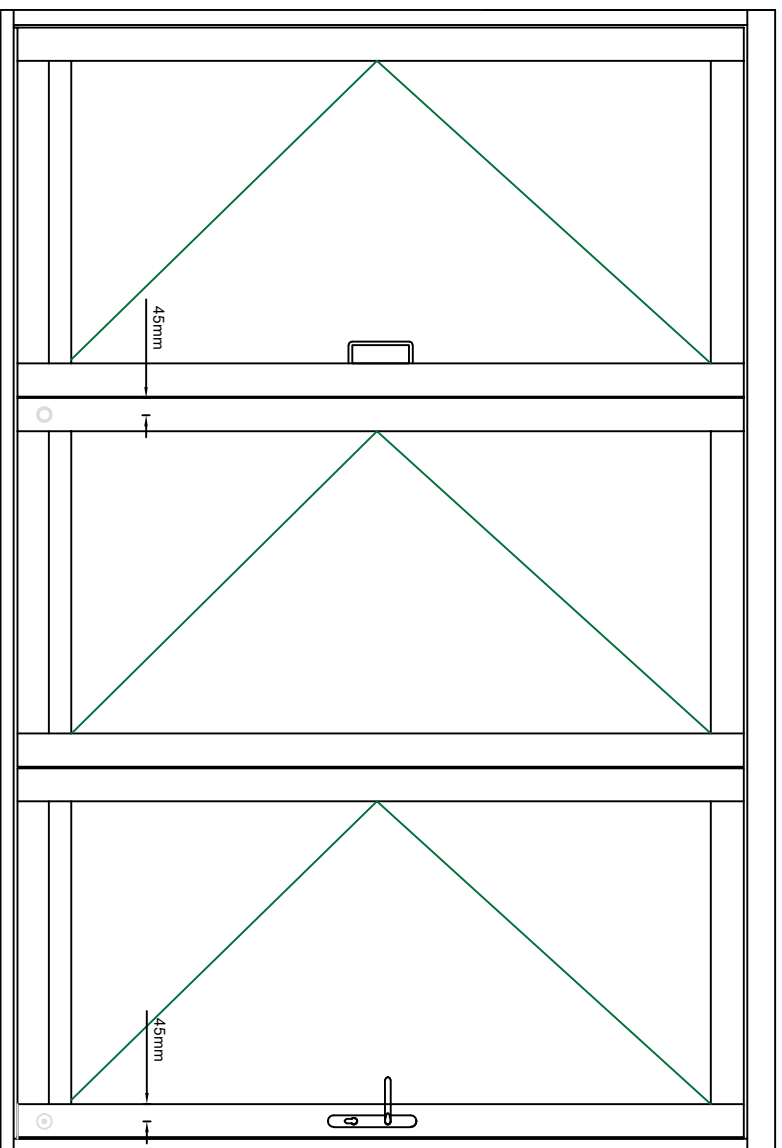

EXAMPLE SHOWN ON MODEL 330

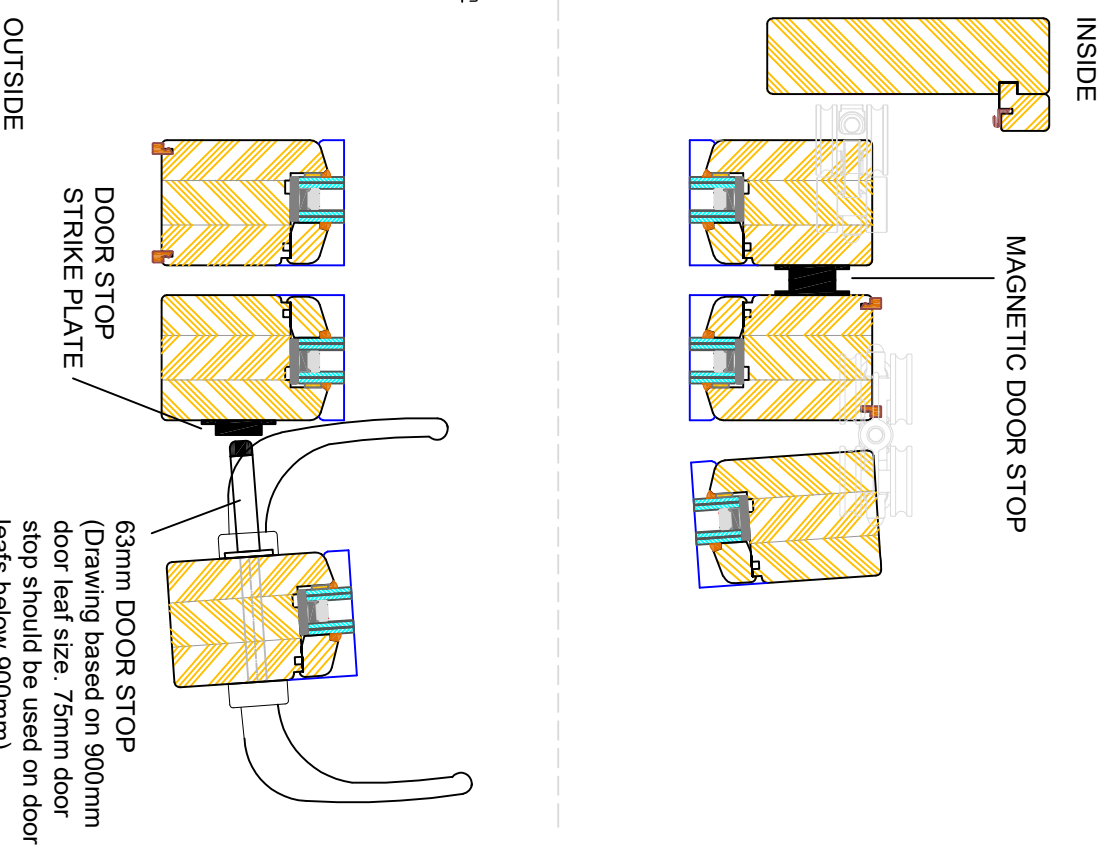
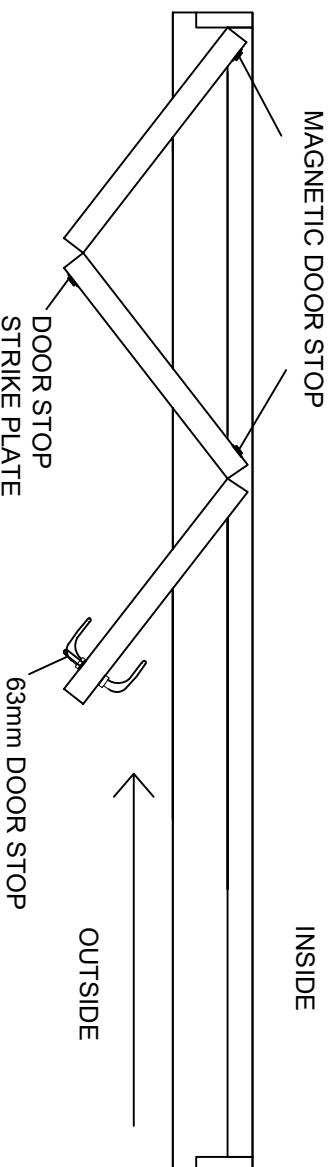

**Open Out Folding Door - All Ranges**  
Optional Magnetic Catch & Door Stop Fitting Positions

DIMENSIONS	PLOT SIZE	SCALE	DATE	REV	DWG NO.
MM	A0	1:1	26.06.2014	A	4317

Please consider the environment before printing

