

**Heritage Single Glazed Open In Flush French Door  
Cill Extension Options**

DIMENSIONS	PLOT SIZE	SCALE	DATE	REV	DWG NO.
MM	A4	1:1	25.09.2019	B	<b>4401</b>

Please consider the environment before printing

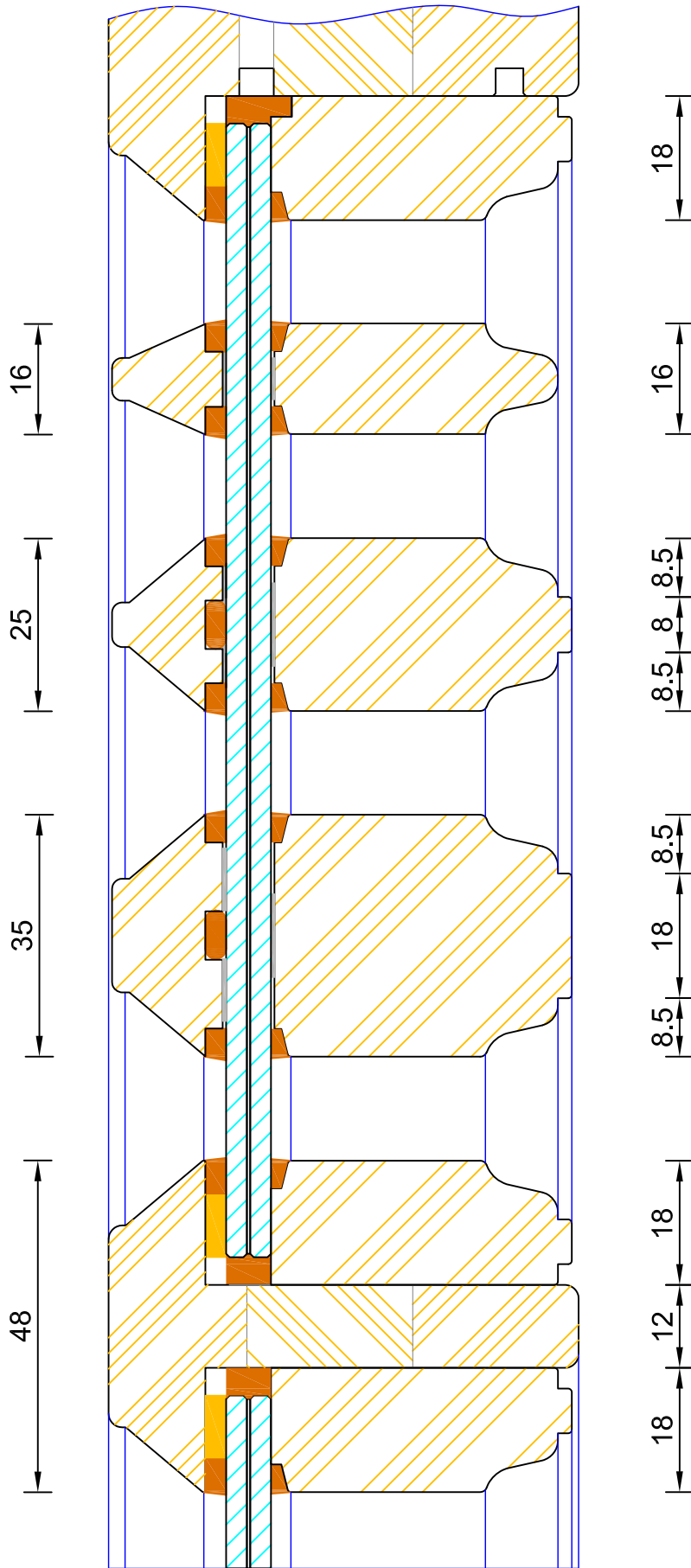

DIMENSIONS	PLOT SIZE	SCALE	DATE	REV	DWG NO.
MM	A4	1:1	01.01.2019	B	<b>4402</b>
Please consider the environment before printing					

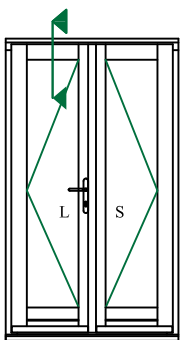
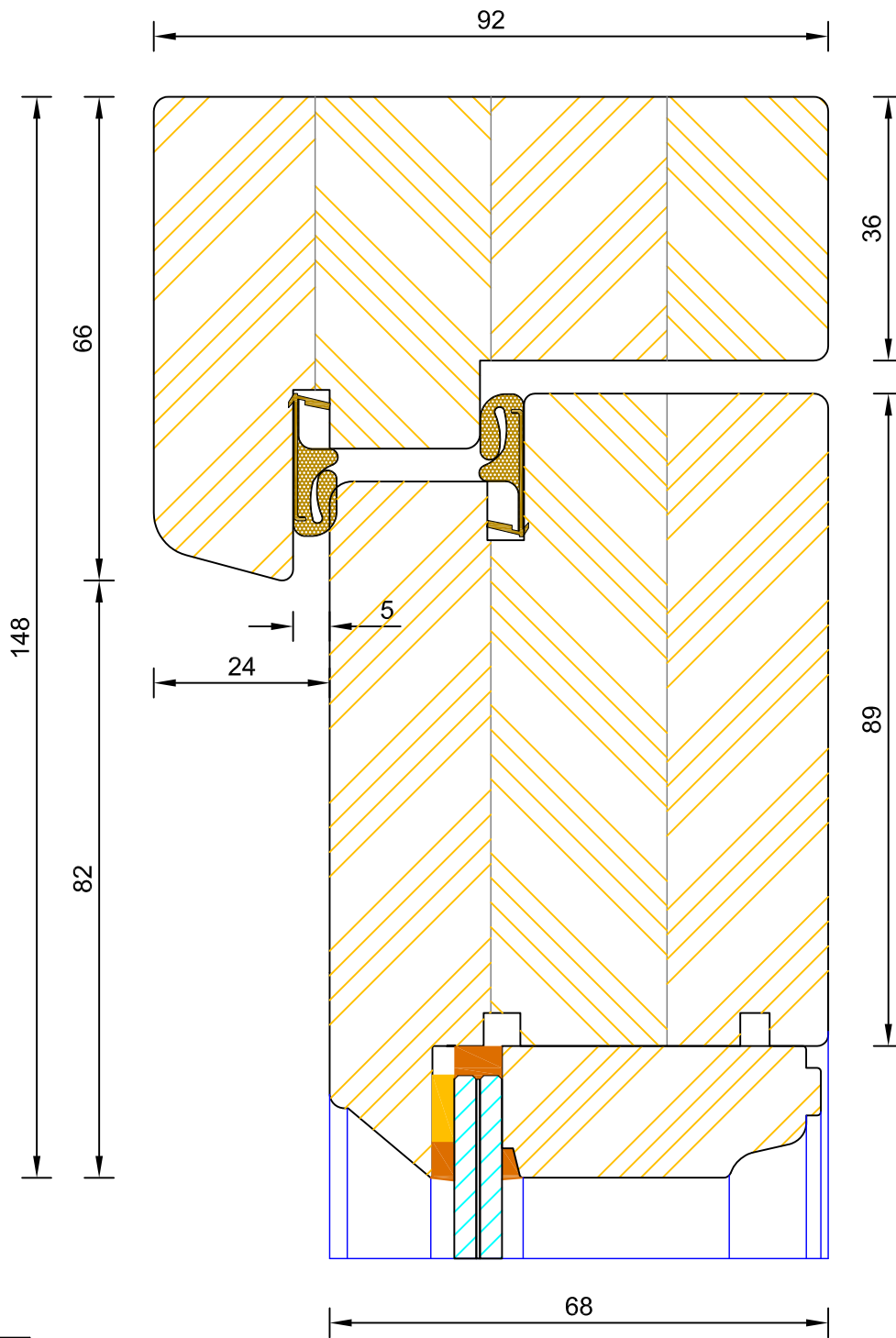

**Heritage Single Glazed Open In Flush French Door  
Frame & Leaf Head**

DIMENSIONS	PLOT SIZE	SCALE	DATE	REV	DWG NO.
MM	A4	1:1	01.01.2019	B	<b>4403</b>
Please consider the environment before printing					

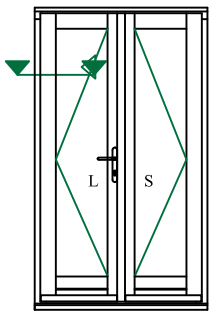
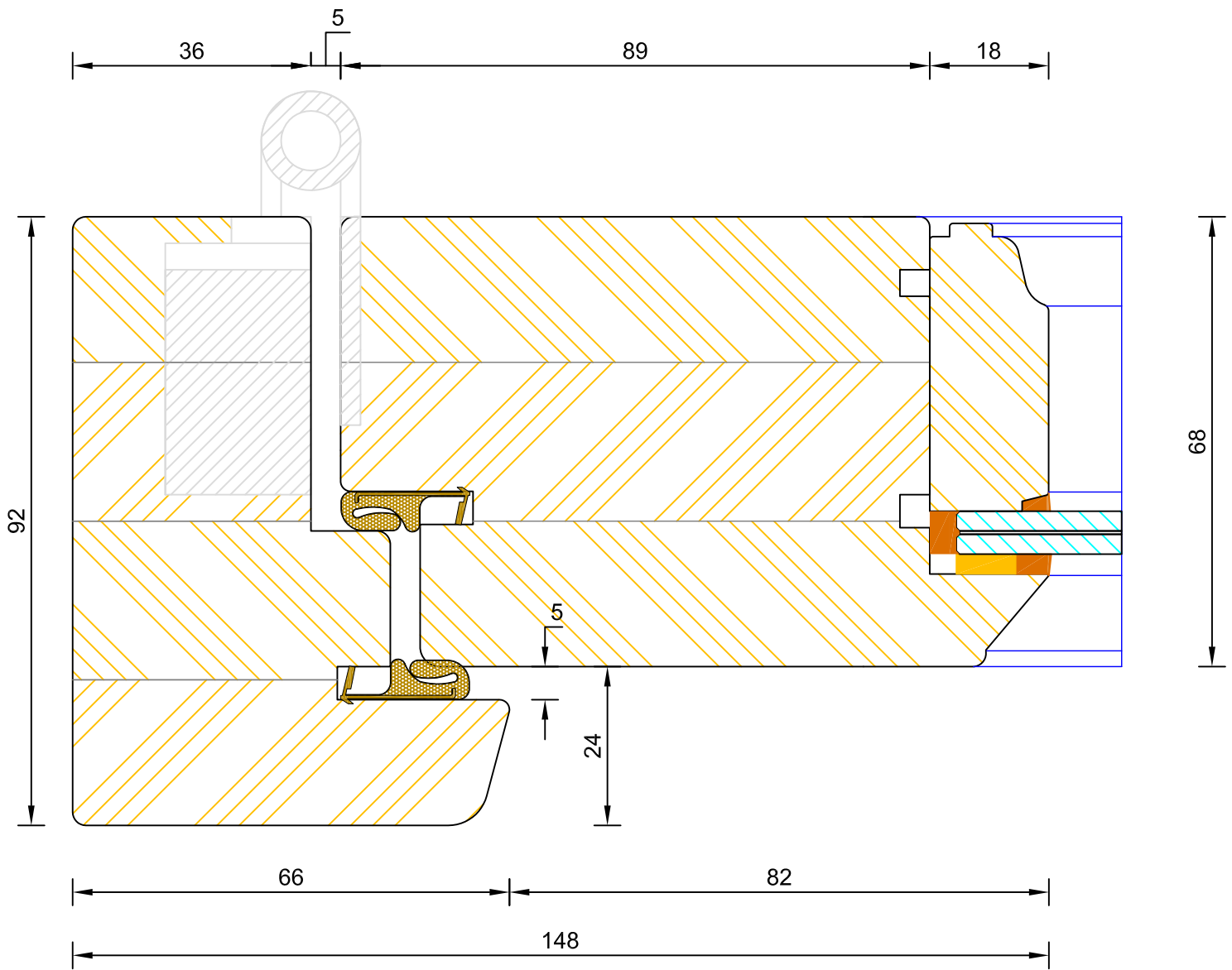

**Heritage Single Glazed Open In Flush French Door  
Frame & Leaf Jamb**

DIMENSIONS	PLOT SIZE	SCALE	DATE	REV	DWG NO.
MM	A4	1:1	01.01.2019	B	<b>4404</b>
Please consider the environment before printing					



# Bereco

## Heritage Single Glazed Open In Flush French Door Flying Mullion (Double Handle)

DIMENSIONS	PLOT SIZE	SCALE	DATE	REV	DWG NO.
MM	A4	1:1	01.01.2019	B	<b>4405</b>

Please consider the environment before printing

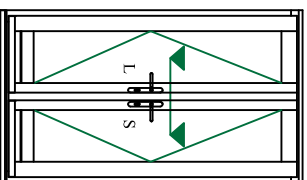
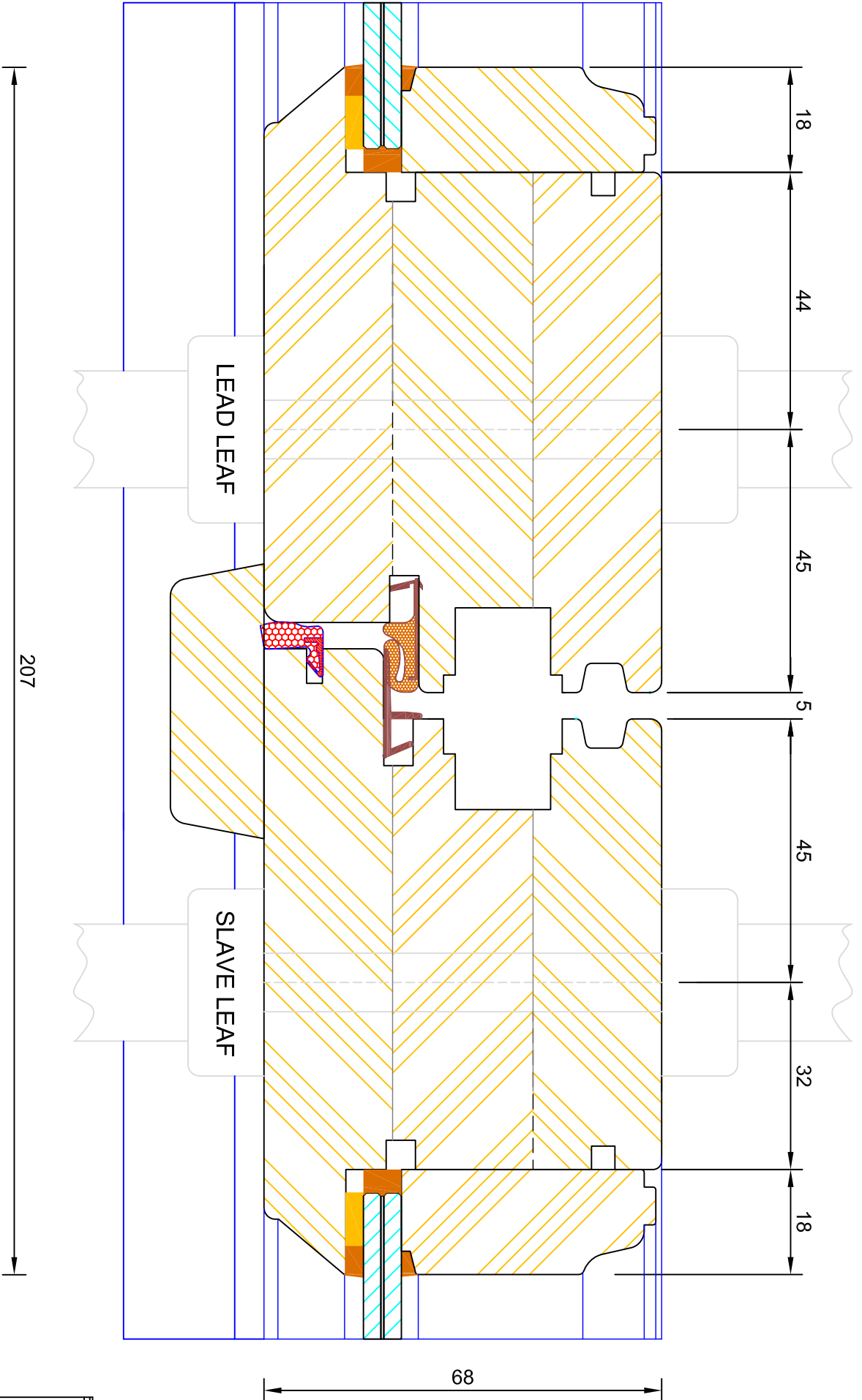

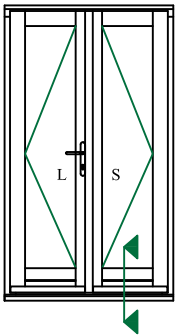
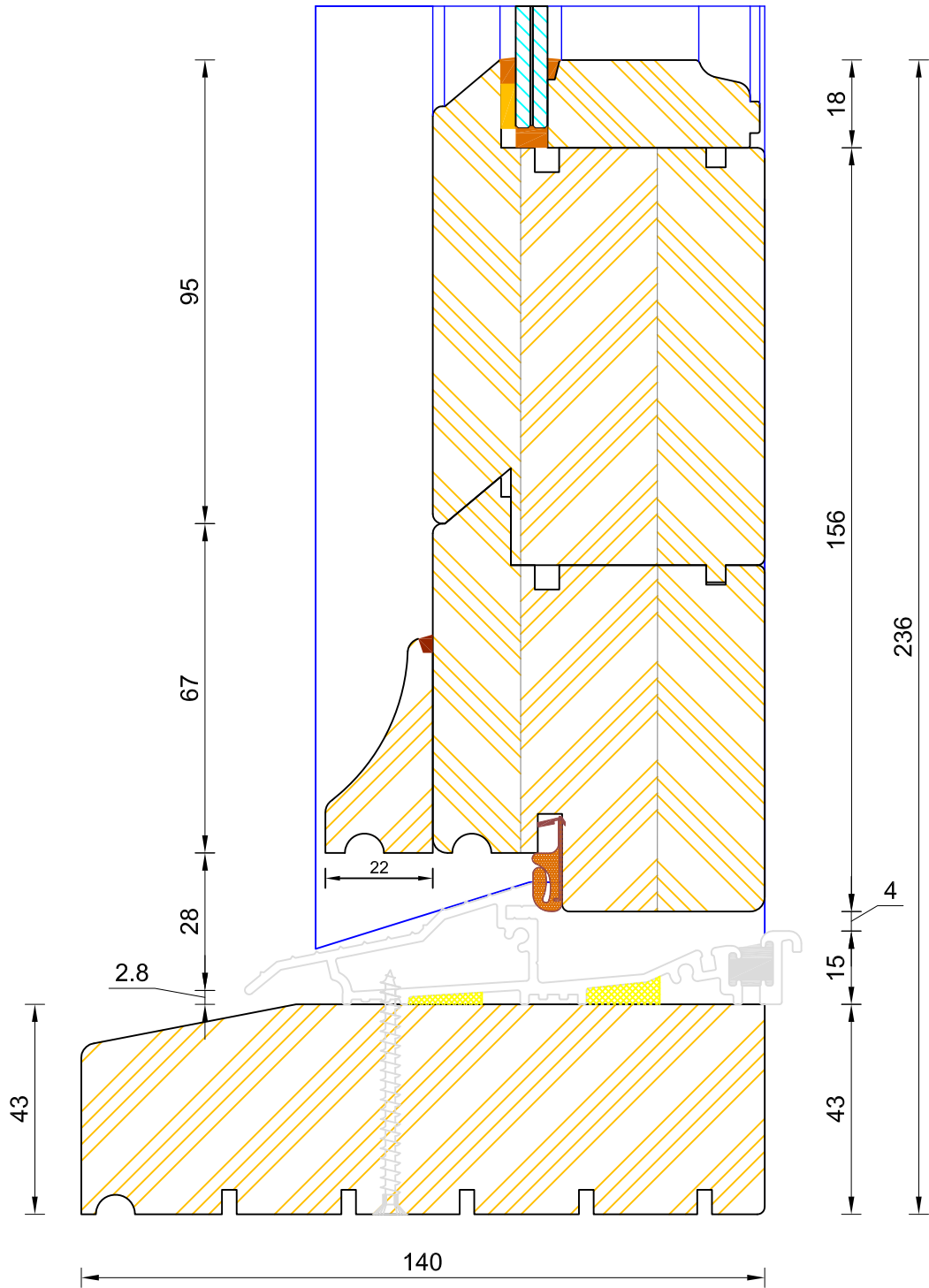

If not otherwise stated, Hardwood Threshold will be stained 5064 Walnut.



**Heritage Single Glazed Open In Flush French Door  
Standard Thresh (140x43mm)**

DIMENSIONS	PLOT SIZE	SCALE	DATE	REV	DWG NO.
MM	A3	1:1	01.01.2019	B	<b>4406</b>
Please consider the environment before printing					

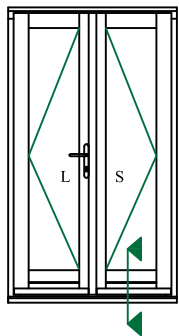
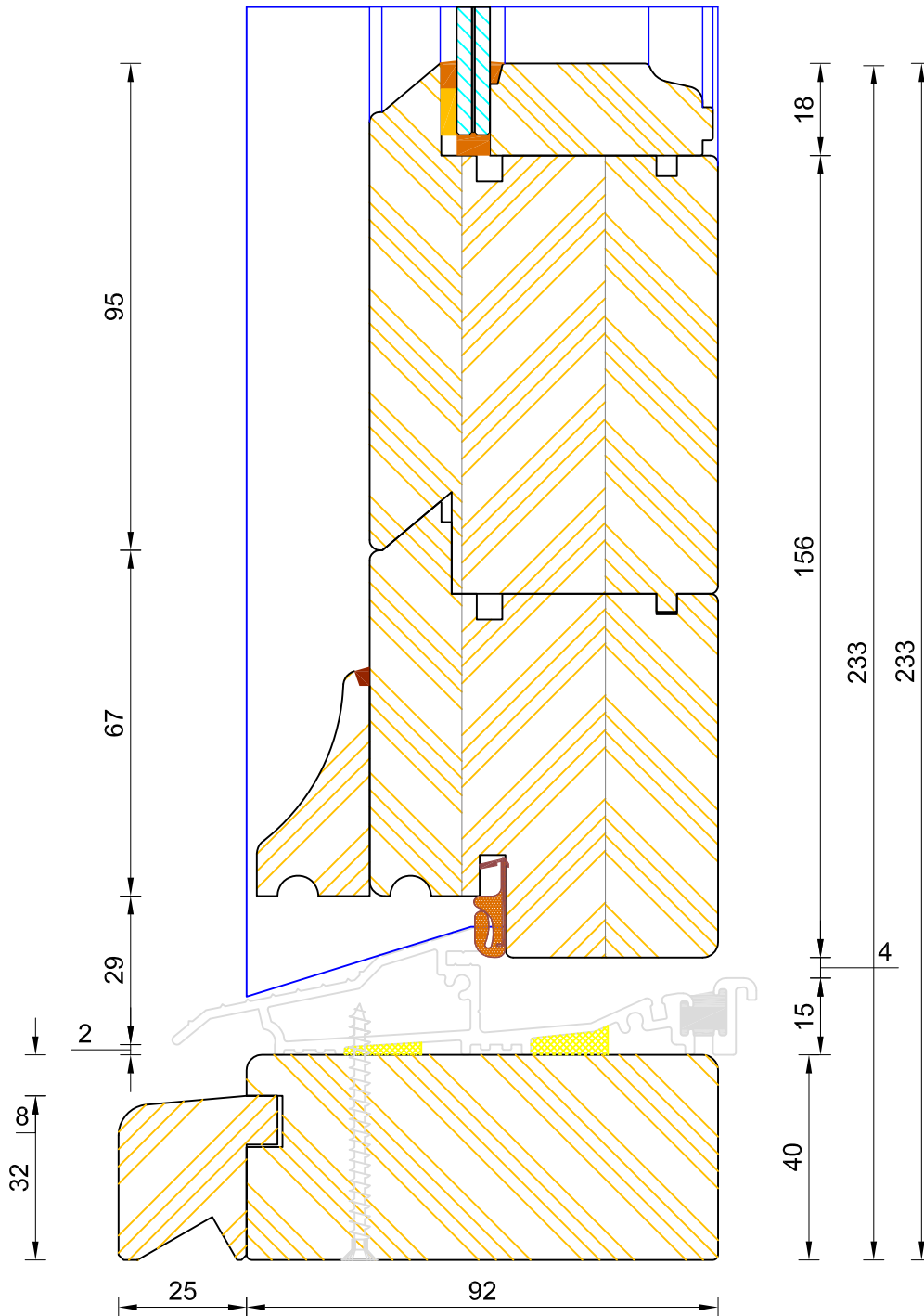

CILL EXTENSION - available options: 25mm (237mm o/a) / 47mm (139mm o/a) / 62mm (154mm o/a) / 87mm (179mm o/a) / 100mm (192mm o/a) / 125mm (217mm o/a) / 140mm (232mm o/a)

NOTE: Cill Extensions should be supported from underneath; the maximum overhang over Brick / Blockwork for cill extension should not exceed 25mm in order to avoid damage when stepped on. Warranties are invalidated when fitted with overhang in excess to that.

If not otherwise stated, Hardwood Threshold will be stained 5064 Walnut.



### Heritage Single Glazed Open In Flush French Door Coupling Thresh

DIMENSIONS	PLOT SIZE	SCALE	DATE	REV	DWG NO.
MM	A3	1:1	01.01.2019	B	<b>4407</b>
Please consider the environment before printing					

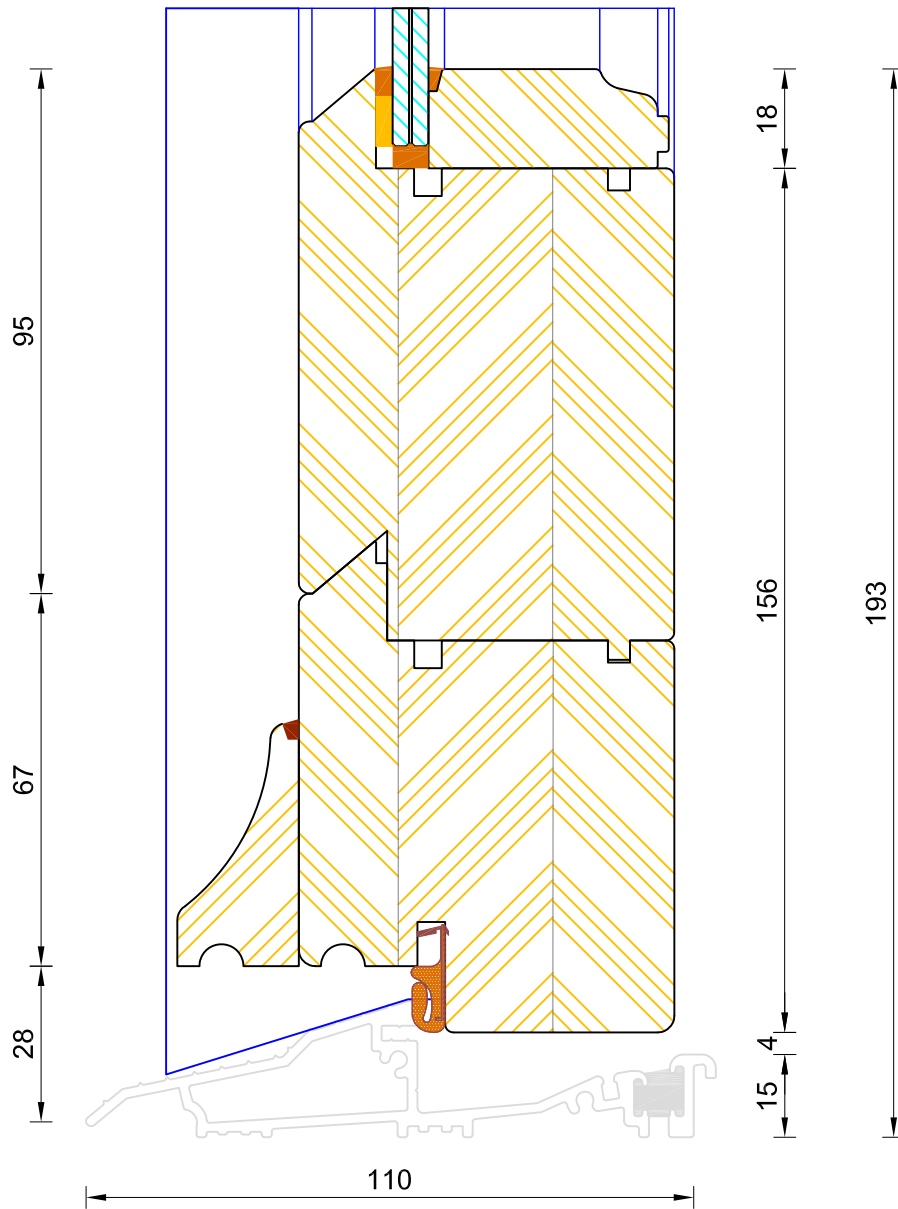
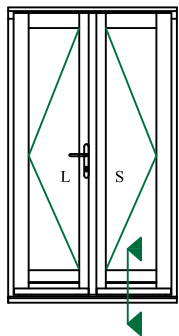

**Heritage Single Glazed Open In Flush French Door  
Mobility Thresh**

DIMENSIONS	PLOT SIZE	SCALE	DATE	REV	DWG NO.
MM	A3	1:1	01.01.2019	B	<b>4408</b>
Please consider the environment before printing					



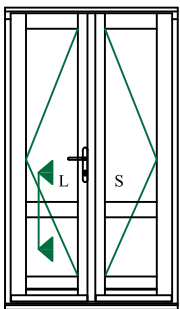
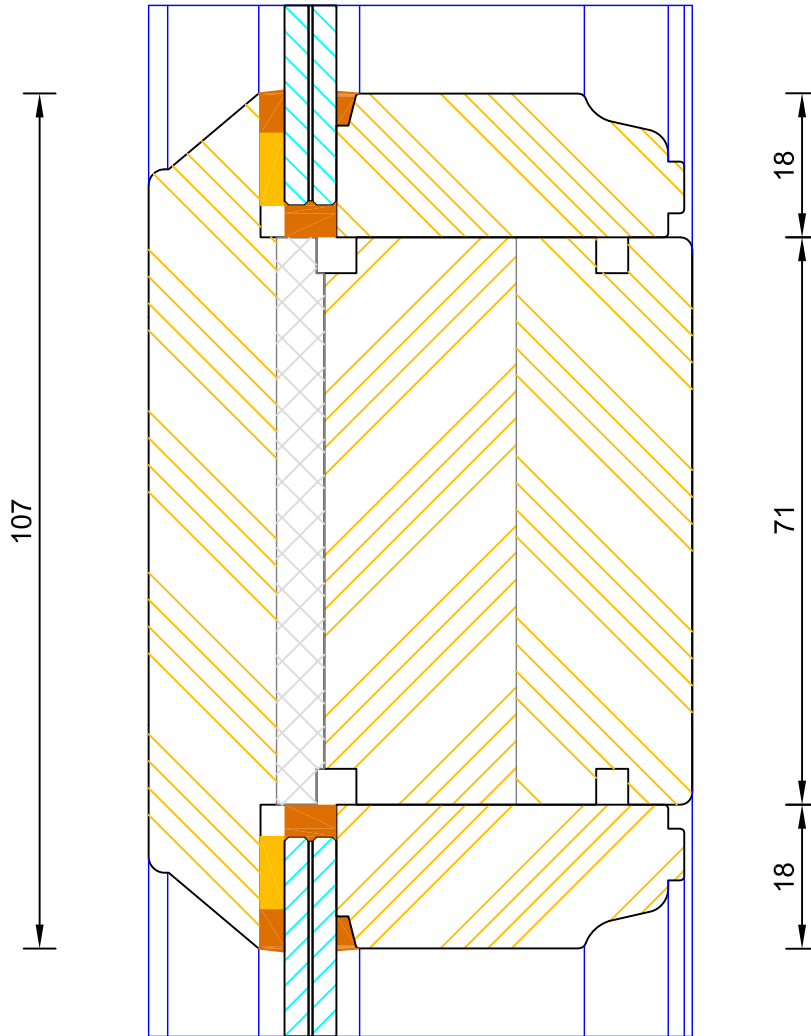

DIMENSIONS	PLOT SIZE	SCALE	DATE	REV	DWG NO.
MM	A4	1:1	01.01.2019	B	<b>4409</b>
Please consider the environment before printing					